

POWER SUPPLY

1AC 24V 300W

- IP65/67 degree of protection
- 600W_{peak} 5s
- 100-240V wide-range input
- 95.6% full load and excellent partial load efficiencies
- DIN rail mounting possible, option "D"
- Output connected to PE (PELV)
- Version without connection to PE on request
- Large output capacitors
- Not potted
- Negligible low input inrush current surge
- Full power between -25°C and +55°C
- DC-OK
- 3 years warranty

GENERAL DESCRIPTION

The FPS300 is an industrial grade power supply for the single-phase mains system incorporated in a rugged wall-mount housing with a degree of protection IP65/67.

It provides one floating, stabilized SELV/PELV output, which is galvanically separated from the input.. In case of an overload or load failure, the output offers hiccup-mode.

The most outstanding features of the FPS series are the compact size, the wide operational temperature range, the low input inrush current and the extremely high efficiencies, which are achieved by various technological design technologies.

Various connector options support the different needs of individual applications. Please contact PULS for possible options.

High immunity to transients and power surges as well as low electromagnetic emission and an international approval package makes usage in nearly every environment possible.

SHORT-FORM DATA

Output voltage	DC 24V	Nominal
Adjustment range	24-28V	Factory setting 24.5V
Output power	Continuous: 360 / 300 / 150W	Up to: +45 / +55 / +70°C
	Short term up to 5s 600 / 300W	+55 / +70°C
Input voltage AC	AC 100-240V	-15 / +10%
Input voltage DC	DC 110-300V	±20%
Power factor	0.99 / 0.97	At 120 / 230Vac
AC Inrush current	3 / 7A _{peak}	At 120 / 230Vac
Efficiency	94.2 / 95.6%	At 120 / 230Vac
Losses	22.4 / 16.2 W	At 120 / 230Vac
Hold-up time	37 / 37ms	At 120 / 230Vac
Temperature range	-25°C to +70°C	Derate linearly from +55°C to +70°C
Size (wxhxd)	182x183x59mm	Without connectors
Weight	1200g / 3.4lb	

ORDER NUMBERS

Description:	Power supply FPS300	
Order Number	Input	Output
FPS300.241-002-101*	HAN Q4/2	HAN Q4/0

Accessories: Chapter 21
Related Products pending

*For DIN rail mounting PSU: (Order Number)D
e.g. FPS300.241-002-101D

MAIN APPROVALS

For details or an complete approval list, see chapter 19.



Pending	Pending
Planned for	Planned for
Q2/2021	Q2/2021

Index



1. Intended Use	3	18. Dielectric Strength.....	17
2. Installation Instructions.....	3	19. Approvals and Fulfilled Standards (Pending).....	18
3. AC-Input	4	20. Regulatory Compliance.....	18
4. DC-Input	5	21. Accessories	19
5. Input Inrush Current.....	5	21.1. DIN RAIL Mounting KIT: ZM.FP-DIN2	19
6. Output.....	6	21.2. Connectors	19
7. Hold-up Time	7	22. Related Products (PENDING).....	20
8. DC-OK Relay Contact	7	23. Application Notes.....	21
9. Efficiency And Power Losses	8	23.1. Repetitive Pulse Loading.....	21
10. Lifetime Expectancy (Pending).....	9	23.2. External Input Protection (Pending)	21
11. MTBF (Pending).....	9	23.3. Inductive and Capacitive Loads	21
12. Functional Diagram	10	23.4. Back Feeding Loads	21
13. Dimensions and Connector Variants	11	23.5. Mounting Orientations.....	22
14. User Interface	12		
15. EMC.....	14		
16. Environment	15		
17. Safety and Protection Features.....	16		

The information given in this document is correct to the best of our knowledge and experience at the time of publication. If not expressly agreed otherwise, this information does not represent a warranty in the legal sense of the word. As the state of our knowledge and experience is constantly changing, the information in this data sheet is subject to revision. We therefore kindly ask you to always use the latest issue of this document (available under www.pulspower.com).

No part of this document may be reproduced or utilized in any form without our prior permission in writing.

Packaging and packaging aids can and should always be recycled. The product itself may not be disposed of as domestic refuse.

TERMINOLOGY AND ABBREVIATIONS

PE and  Symbol	PE is the abbreviation for Protective Earth and has the same meaning as the symbol  .
Earth, Ground	This document uses the term “earth” which is the same as the U.S. term “ground”.
T.b.d.	To be defined, value or description will follow later.
AC 230V	A figure displayed with the AC or DC before the value represents a nominal voltage with standard tolerances (usually ±15%) included. E.g.: DC 12V describes a 12V battery disregarding whether it is full (13.7V) or flat (10V)
230Vac	A figure with the unit (Vac) at the end is a momentary figure without any additional tolerances included.
50Hz vs. 60Hz	As long as not otherwise stated, AC 100V and AC 230V parameters are valid at 50Hz mains frequency. AC 120V parameters are valid for 60Hz mains frequency.
may	A key word indicating flexibility of choice with no implied preference.
shall	A key word indicating a mandatory requirement.
should	A key word indicating flexibility of choice with a strongly preferred implementation.

1. Intended Use

This device is designed for indoor use and is intended for commercial applications, such as in industrial control, process control, monitoring and measurement equipment or the like.

Do not use this device in equipment where malfunction may cause severe personal injury or threaten human life. If this device is used in a manner outside of its specification, the protection provided by the device may be impaired.

2. Installation Instructions

DANGER

Risk of electrical shock, fire, personal injury or death.

- Turn power off before working on the device. Protect against inadvertent re-powering.
- Do not open, modify or repair the device.
- Do not open the unit as high voltages are present inside.
- Do not use in wet locations or in areas where moisture or condensation can be expected.
- Do not touch during power-on and immediately after power-off. Hot surfaces may cause burns.
- Install the device on a large enough flat surface. Sharp edges on the back may cause injury.
- If damages or malfunctioning occur during installation or operation, immediately turn power off and send unit to the factory for inspection.
- The device is designed as “Class of Protection I” equipment according to IEC 61140. Do not use without a proper PE (Protective Earth) connection.

WARNING

Risk of damages on the device

- Keep the following minimum installation clearances: 30mm on top and bottom, 10mm on the front and 10mm left and right side.
- The maximum surrounding air temperature is +70°C (+158°F). The operational temperature is the same as the ambient or surrounding air temperature and is defined 2cm below the device.
- The device is designed to operate in areas between 5% and 95% relative humidity.
- Clean only with a damp cloth.

Obey the following installation instructions:

This device may only be installed and put into operation by qualified personnel. This device does not contain serviceable parts. The tripping of an internal fuse is caused by an internal defect. Install the device on a large enough flat surface with the terminals on the bottom of the device. Other mounting orientations require a reduction in output current, chapter 22.5.

For wall mounting use 4 screws. Two on top and 2 on bottom mounting holes. Recommended screw size is M4 (UNC 8-32). The enclosure of the device provides a degree of protection of IP65/67 when installed with all mating connectors firmly connected. The device is designed for pollution degree 3 areas in controlled environments.

The negative potential of the outputs is permanently connected to PE within the unit. Do not connect the negative potential of the output to PE outside the unit.

The device is suitable to be supplied from TN, TT or IT mains networks. The voltage between the input terminals and the PE potential must not exceed 264Vac. The device is designed for altitudes up to 5000m (16400ft). Above 2000m (6560ft) a reduction in output current and over voltage category is required. The device is designed, tested and approved for branch circuits up to 20A (UL) and 32A (IEC) without additional protection device. If an external fuse is utilized, do not use circuit breakers smaller than 6A B- or C-Characteristic to avoid a nuisance tripping of the circuit breaker.

The device is designed for convection cooling and does not require an external fan. Do not obstruct airflow and do not cover ventilation fins!

3. AC-Input

The device is suitable to be supplied from TN, TT or IT mains networks. For more details, please review chapter 2.

AC input voltage rated range	Nom.	AC 100-240V	Suitable for TN-, TT- and IT mains networks
AC input operating range		85-264Vac 264-300Vac	Continuous operation For maximal 500ms
Input frequency	Nom.	50–60Hz	±6%
Turn-on voltage	Typ.	80Vac	Steady-state value, see Fig. 3-1
Shut-down voltage	Typ.	70Vac	Steady-state value, see Fig. 3-1
External input protection	See recommendations in chapter 2.		

Certification in progress

		AC 100V	AC 120V	AC 230V	
Input current	typ.	3.98A	3.2A	1.68A	At 360W, symmetrical phase voltages, see Fig. 3-3 Power
Power factor*)	typ.	0.99	0.99	0.97	At 360W, see Fig. 3-4
Start-up delay	typ.	1s	1s	1s	At 300W, see Fig. 3-2
Rise time	typ.	22ms	22ms	22ms	At 300W constant current load, 0mF load, see Fig. 3-2
	typ.	48ms	46ms	35ms	At 300W constant current load, 12.5mF, see Fig. 3-2
Turn-on overshoot	Max.	200mV	200mV	200mV	See Fig. 3-2

*) The power factor is the ratio of the true (or real) power to the apparent power in an AC circuit.

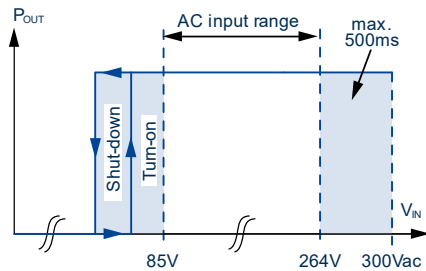

Fig. 3-1: Input voltage range

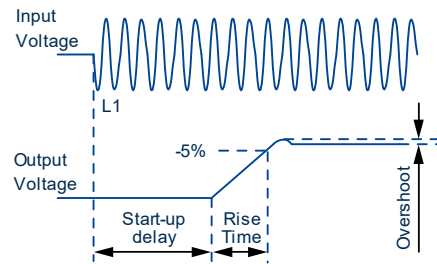

Fig. 3-2: Turn-on behavior, definitions

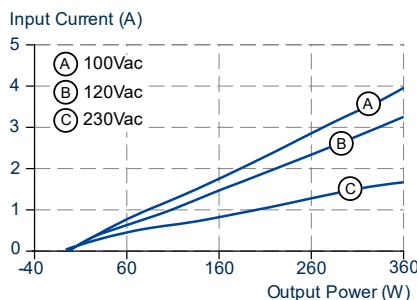

Fig. 3-3: Input current vs. output Power at 24V output voltage

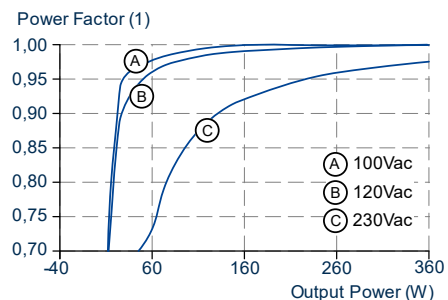

Fig. 3-4: Power factor vs. output power at 24V output voltage

4. DC-Input

The device is suitable to be supplied from a DC input voltage.

DC input	Nom.	DC 110-300V	±20%
DC input range	Min.	88Vdc	
	Max.	360Vdc	
DC input current	Typ.	2.90A	At 110Vdc, at 24V, 300W
	Typ.	1.04A	At 300Vdc, at 24V, 300W
Turn-on voltage	Typ.	80Vdc	Steady state value
Shut-down voltage	Typ.	70Vdc	Steady state value

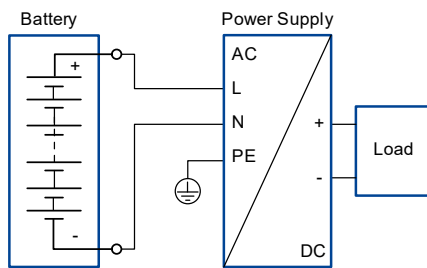

Fig. 4-1: Wiring for DC Input

Instructions for DC use:

- Use a battery or a similar DC source. A supply from the intermediate DC-bus of a frequency converter is not recommended and can cause a malfunction or damage the unit.
- Connect +pole to L and -pole to N.
- Connect the PE terminal to an earth wire or to the machine ground.

5. Input Inrush Current

An active inrush limitation circuit (NTCs, which are bypassed by a relay contact) limits the input inrush current after turn-on of the input voltage.

The charging current into EMI suppression capacitors is disregarded in the first microseconds after switch-on.

		AC 100V	AC 120V	AC 230V
Inrush current	typ.	2.18A _{peak}	2.6A _{peak}	6A _{peak}

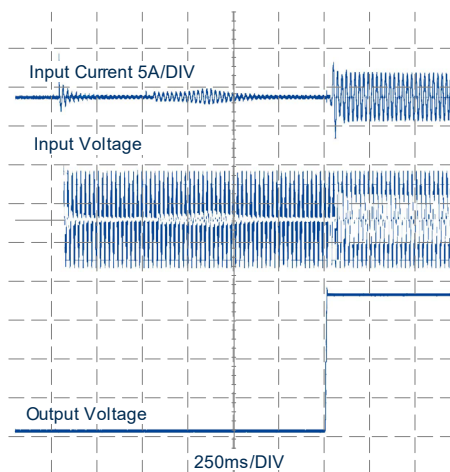

Fig. 5-1: Typical turn-on behavior at nominal load and 25°C ambient temperature

6. Output

The output provide a (PELV/ES1) rated voltage, which is galvanically isolated from the input voltage. The negative potential of the output is permanently connected to PE within the unit.

The device is designed to supply any kind of loads, including capacitive and inductive loads. If capacitors with a capacitance >100mF are connected to the output, this the unit might charge the capacitor in hiccup mode.

Output voltage	nom.	24V	Factory setting 24.5V
Adjustment range		24-28V	Adjustable in steps: 24V, 24.5V, 25V, 25.5V, 26V, 26.5V, 27V and 28V
Factory setting	typ.	24.5V	±0.2%, at nominal load
Line regulation	max.	10mV	Between 85 and 300Vac input voltage change
Load regulation	typ.	75mV	Between 0 and 360W output load, static value
Ripple and noise voltage	max.	50mVpp	Bandwidth 20Hz to 20MHz, 50Ohm
Total output power	nom.	360W ¹⁾	Up to +45°C at ambient temperatures, see Fig. 6-1
	nom.	300W	At +55°C at ambient temperatures
	nom.	150W	At +70°C at ambient temperatures
short term up to 5s	nom.	600W	Up to +55°C at ambient temperatures, see Fig. 6-1
	nom.	300W	At +70°C at ambient temperatures
		Derate linearly between +55°C and +70°	
Overload/ short-circuit current	typ.	25A / 0A	At heavy overloads (when output voltage falls below 13V), the power supply delivers continuous output current for 2s. After this, the output is switched off for approx. 18s before a new start attempt is automatically performed. This cycle is repeated as long as the overload exists. If the overload has been cleared, the device will operate normally, see Fig. 6-2. Load impedance 10mOhm. Discharge current of output capacitors is not included.
Output capacitance	typ.	12 500µF	Included inside the power supply
Parallel Use			Do not parallel units for higher output currents
Back-feeding loads	max.	35V / 4J	The unit is resistant and does not show malfunctioning when a load feeds back voltage to the power supply. It does not matter whether the power supply is on or off. The absorbing energy can be calculated according to the built-in large sized output capacitor.

1) Power Boost This power/ current is continuously allowed up to an ambient temperature of 45°C. Above 45°C, do not use this power or current longer than a duty cycle of 10% and/ or not longer than 1 minute every 10 minutes.

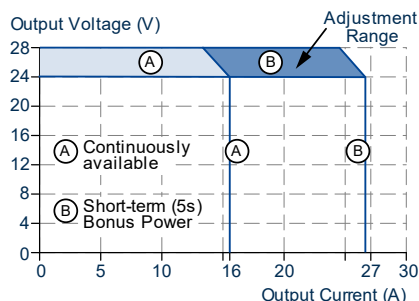

Fig. 6-1: Output voltage vs. output current, for continuous load, typ.

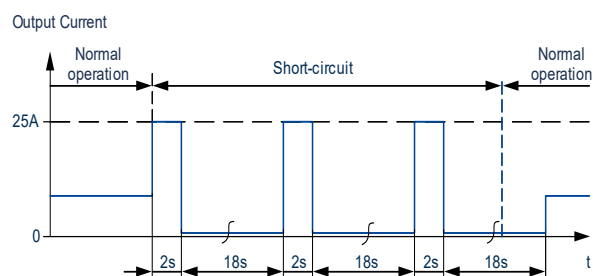

Fig. 6-2: Short-circuit on output, HiccupPLUS mode, typ.

7. Hold-up Time

The hold-up time is the time during which a power supply's output voltage remains within specification following the loss of input power. The hold-up time is output load dependent. At no load, the hold-up time can be up to several seconds. The status LED is also on during this time.

		AC 100V	AC 120V	AC 230V	
Hold-up Time	typ.	75ms	75ms	75ms	At 150W output load, see Fig. 7-1
	min	56ms	56ms	56ms	At 150W output load, see Fig. 7-1
	typ.	44ms	44ms	44ms	At 300W output load, see Fig. 7-1
	min	29ms	29ms	29ms	At 300W output load, see Fig. 7-1

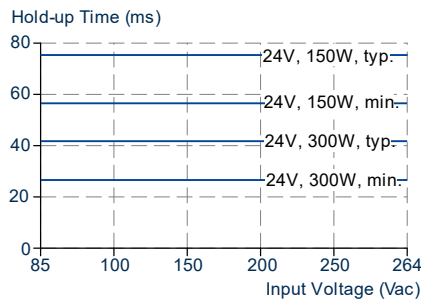

Fig. 7-1: Hold-up time vs. input voltage

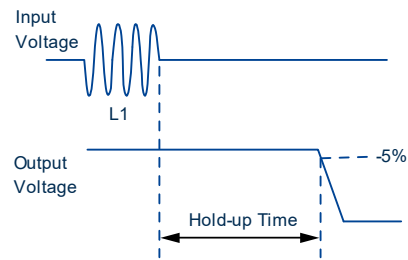

Fig. 7-2: Shut-down behavior, definitions

8. DC-OK Relay Contact

This feature monitors the output voltage, which is produced by the power supply itself. It is independent of an eventually present external voltage on the output of the power supply.

Contact closes	As soon as the output voltage reaches typ. 22Vdc. The DC-OK Relay Contact is synchronized with the Status Led.
Contact opens	As soon as the output voltage dips below 22Vdc. Short dips will be extended to a signal length of 100ms. Dips shorter than 1ms will be ignored.
Switching hysteresis	1V
Contact ratings	Maximal 60Vdc 0.3A, 30Vdc 1A, 30Vac 0.5A, resistive load Minimal permissible load: 1mA at 5Vdc
Isolation voltage	See dielectric strength table in chapter 18

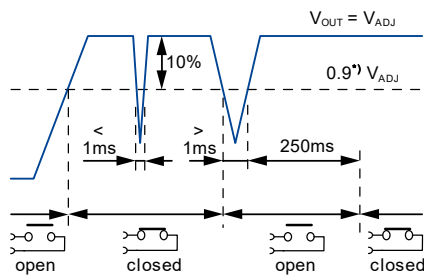

Fig. 8-1: DC-OK relay contact behavior

9. Efficiency And Power Losses

		AC 100V	AC 120V	AC 230V	
Efficiency	typ.	93.6%	94.3%	95.7%	At 24V, 300W
Average efficiency	typ.	92.9%	93.5%	94.6%	25% at 80W, 25% at 150W, 25% at 220W, 25% at 300W
Power losses	typ.	2.7W	2.8W	2.2W	At 24V, 0W (no load)
	typ.	10.7W	10.0W	8.3W	At 24V, 150W (half load)
	typ.	20.5W	18.2W	16.2W	At 24V, 300W (full load)

*) The average efficiency is an assumption for a typical application where the power supply is loaded with 25% of the nominal load for 25% of the time, 50% of the nominal load for another 25% of the time, 75% of the nominal load for another 25% of the time and with 100% of the nominal load for the rest of the time.

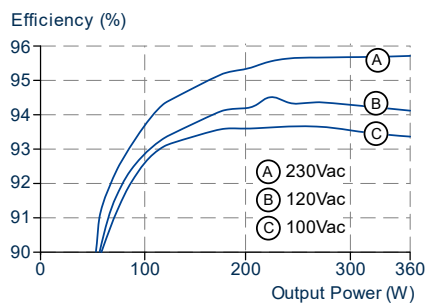

Fig. 9-1: Efficiency vs. output power at 24V, typ.

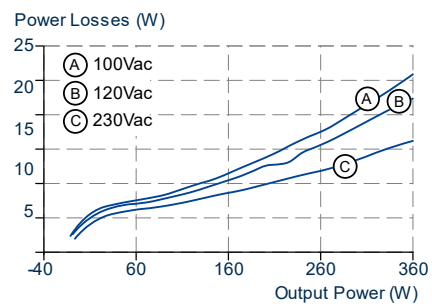

Fig. 9-2: Losses vs. output power at 24V, typ.

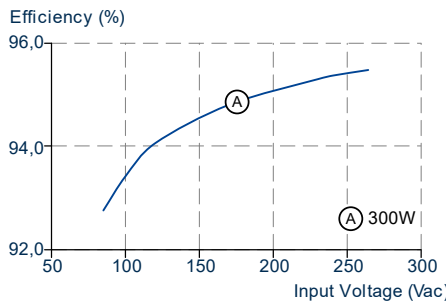

Fig. 9-3: Efficiency vs. input voltage at 24V, 300W, typ.

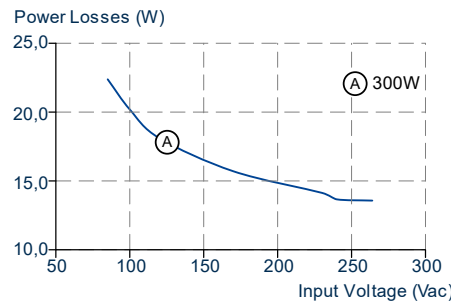

Fig. 9-4: Losses vs. input voltage at 24V, 300W, typ.

10. Lifetime Expectancy (Pending)

The Lifetime expectancy shown in the table indicates the minimum operating hours (service life) and is determined by the lifetime expectancy of the built-in electrolytic capacitors. Lifetime expectancy is specified in operational hours and is calculated according to the capacitor's manufacturer specification.

The manufacturer of the electrolytic capacitors only guarantees a maximum life of up to 15 years (131 400h). Any number exceeding this value is a calculated theoretical lifetime which can be used to compare devices.

	AC 100V	AC 120V	AC 230V
Calculated lifetime expectancy	t.b.d.	t.b.d.	t.b.d.
	t.b.d.	t.b.d.	t.b.d.
	t.b.d.	t.b.d.	t.b.d.
	t.b.d.	t.b.d.	t.b.d.

11. MTBF (Pending)

MTBF stands for **Mean Time Between Failure**, which is calculated according to statistical device failures, and indicates reliability of a device. It is the statistical representation of the likelihood of a unit to fail and does not necessarily represent the life of a product.

The MTBF figure is a statistical representation of the likelihood of a device to fail. A MTBF figure of e.g. 1 000 000h means that statistically one unit will fail every 100 hours if 10 000 units are installed in the field. However, it can not be determined if the failed unit has been running for 50 000h or only for 100h.

For these types of units the MTTF (**Mean Time To Failure**) value is the same value as the MTBF value.

	AC 100V	AC 120V	AC 230V
MTBF SN 29500, IEC 61709	t.b.d.	t.b.d.	t.b.d.
	t.b.d.	t.b.d.	t.b.d.
MTBF MIL HDBK 217F	t.b.d.	t.b.d.	t.b.d.
	t.b.d.	t.b.d.	t.b.d.
	t.b.d.	t.b.d.	t.b.d.
	t.b.d.	t.b.d.	t.b.d.

12. Functional Diagram

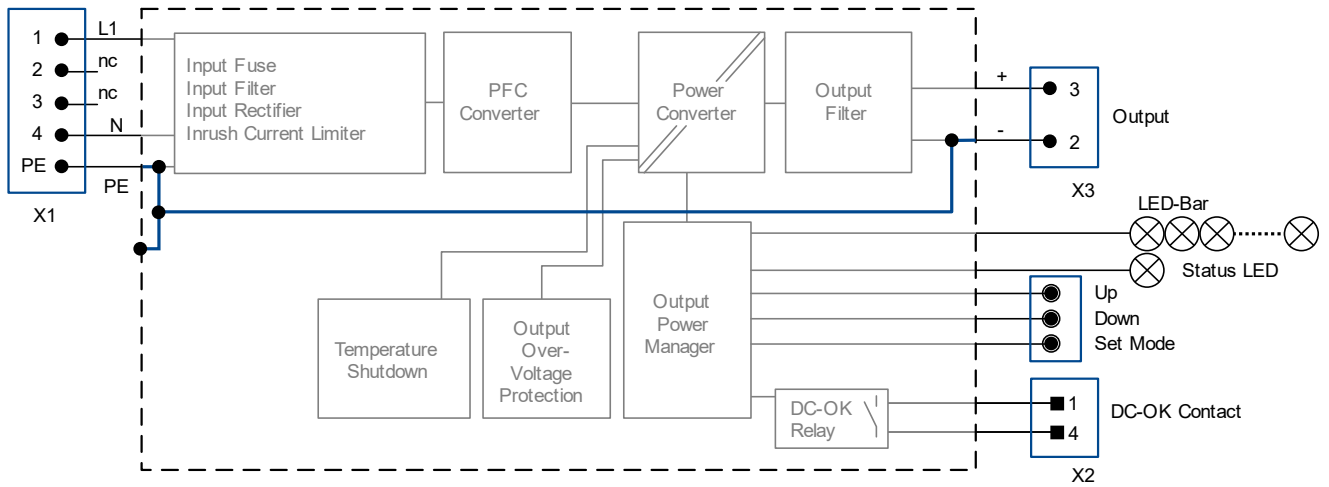
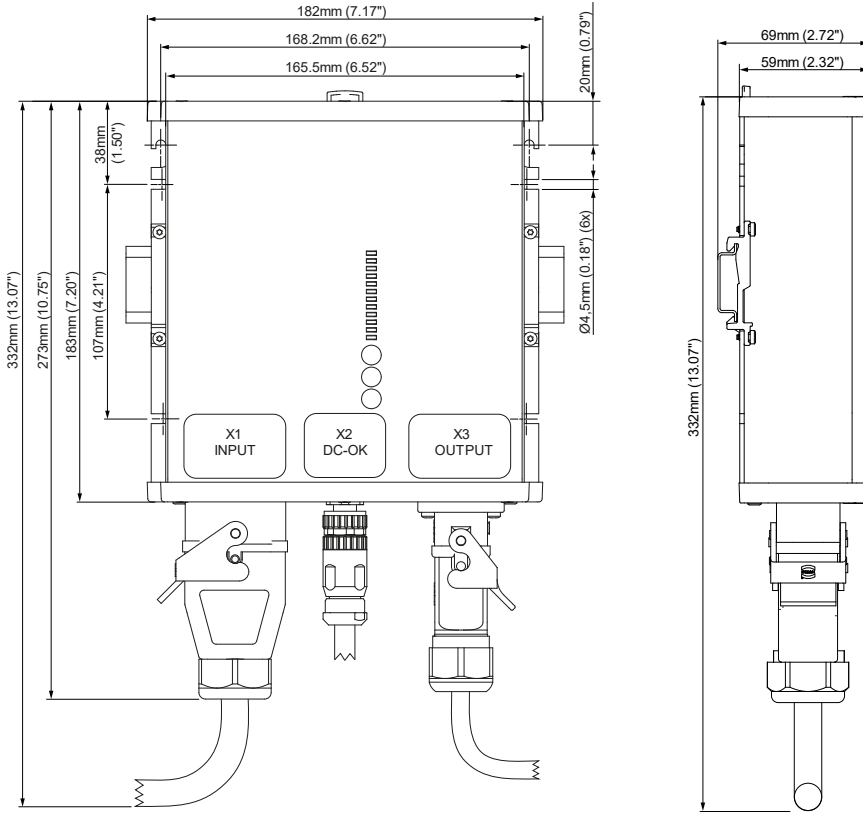

Fig. 12-1: Functional Diagram FPS300.241-002-101

13. Dimensions and Connector Variants

FPS300.241-002-101



Width	182mm / 7.17"
Height	183mm / 7.2"
Depth	59mm / 2.32"
Weight	1200g / 2.7lb
Housing material	
Body:	Aluminium alloy
Covers:	Hi-grade polycarbonate
Installation clearances	See chapter 2

Input Connection (X1):



Harting HanQ4/2	Q4/2 Set AS female 2.5-6mm ² 7-13mm	Harting order code 6104401263700	PULS order code ZCF.hanq42
	Q4/2 Set AS female 2.5-6mm ² 14-17mm	Harting order code 6104401263800	PULS order code ZCF.hanq42-1
Pin assignment	Pin 1	L1	
	Pin 4	N	
	Pin with the PE symbol	PE connection	

IO-Link Connection (X2):

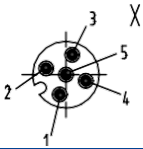

M12 A coded	M12-A 5pin cut clamp female 0.34-0.5mm ² / 6-8mm	Harting order code 21032722505	PULS order code ZCF.m12a5p
Pin assignment	Pin 1 and Pin 4 for relay contact		

Output Connection (X3):

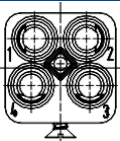

Harting HanQ4/0	Q4/0 Set male 2.5mm ² 6-12mm	Harting order code 6104401265100	PULS order code ZCM.hanq40
Pin assignment	Pin 3	(+) pole	
	Pin 2	(-) pole	

All parameters are specified at 24V, 12.5A, 230Vac, 25°C ambient and after a 5 minutes run-in time unless otherwise noted.

14. User Interface

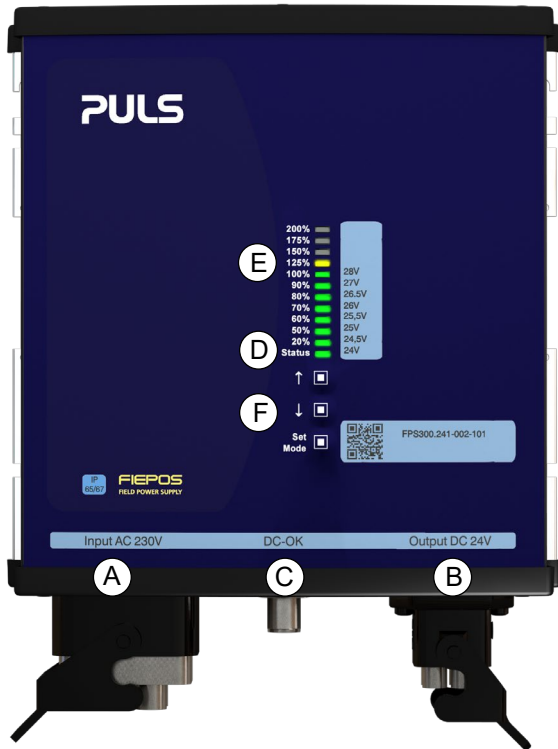

- A. Input Connector
- B. Output Connector
- C. IO Link Connector
- D. Status LED
- E. LED Bar
- F. Set Mode and Up and Down Button

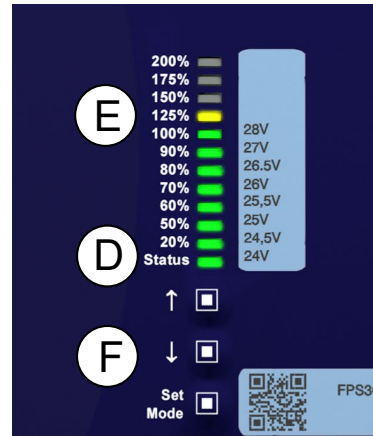

LED Bar Signalization Overview

The user menu consists of the LED bar display and 3 push buttons. Two menus are available – the monitoring menu and the configurations menu. Variants with a single output feature only a menu for the Total Power Monitor and the Output Voltage Configuration.

After the start-up of the PSU, the menu is in the output power monitoring mode by default.

Output Power Monitoring

The LED bar shows the actual output power in percentage of 300W. So if the device provides 120W the LEDs light up green including the 40% LED. The LEDs light up orange if the delivered power exceeds 300W.

By default, the PSU displays the total output power after startup.

Status LED

The Status LED is used to signalize special conditions.

- **STATUS LED lights up green continuously**
DC voltage is above 22V and all outputs run according to their settings.
- STATUS LED is off continuously**
DC voltage is not OK or power supply is not powered.
- **STATUS LED lights up red continuously**
AC input dropout
- ⚡ **STATUS LED flashes orange with 1Hz**
Hiccup^{plus} is OFF during the 18s Hiccup off state
- ⚡ **STATUS LED flashes red with 1Hz**
The unit has turned off due to overtemperature and the output is switched off. As soon as the temperature goes down to a safe level the output switches on again

See actual output voltage

To see the actual output voltage press the “Set Mode” button for 3s. All LEDs will be flashing for 1s and the LED indicating the output voltage will remain on. Wait for 20s and the LED bar will return to output power monitoring mode.

Setting Functions

Change output voltage

- Press SET / MODE for 3s. All LEDs light up for ones.
- The LED display is now in Voltage Set Mode. A green LED signals the currently set voltage: e.g. the LED next to 20% represents a value of 24.5V.
- All orange LEDs are off in this mode.
- Voltage steps are labelled on the right hand side of the LED bar.
- Push the UP button to increase the set point by one step.
- Push the DOWN button to decrease the set point by one step.
- New set point is applied immediately.
- Exit the configuration menu by waiting for 20s without pressing any button – PSU will switch to output power monitoring mode automatically.

Lock Buttons

- In any monitoring menu, press UP and DOWN buttons simultaneously for 3s. All LEDs start
 - flashing for 5s to indicate that button lock status has changed.
- After that, the display returns to output power monitoring mode.
- If SET / MODE button is pushed for 3s and the button lock is activated, all LEDs starts flickering for 5s to indicate that buttons are locked
- Deactivate the button lock feature, by pressing the UP and DOWN buttons simultaneously for 3s in any monitoring menu again.
 - All LEDs start flashing for 5s to indicate that button lock status has changed.

15. EMC

The EMC behavior of the device is designed for applications in industrial environment as well as in residential, commercial and light industry environments.

The device is investigated according to EN 61000-6-1, EN 61000-6-2, EN 61000-6-3, EN 61000-6-4, EN 61000-3-2 and EN 61000-3-3.

EMC immunity

Electrostatic discharge	EN 61000-4-2	Contact discharge	8kV	Criterion A
Air discharge		Air discharge	15kV	Criterion A
Electromagnetic RF field	EN 61000-4-3	80MHz - 2.7GHz	20V/m	Criterion A
		2.7GHz - 6GHz	10V/m	Criterion A
Magnetic field	EN 61000-4-8	50Hz/60Hz	30A/m	Criterion A
Fast transients (Burst)	EN 61000-4-4	AC Input lines	4kV	Criterion A
		DC Output lines	4kV	Criterion A
		DC OK Output	4kV	Criterion A
Surge voltage on AC input	EN 61000-4-5	L to N	2kV	Criterion A
		L to PE, N to PE	4kV	Criterion A
Surge voltage on DC output	EN 61000-4-5	+ to -	1kV	Criterion A
		+/- to PE	2kV	Criterion A
Surge voltage on Output OK	EN 61000-4-5	DC-OK to PE	1kV	Criterion A
Conducted immunity	EN 61000-4-6	0.15 - 80MHz	20V	Criterion A
Voltage dips	EN 61000-4-11	0% of 100Vac	0Vac, 20ms	Criterion A
		40% of 100Vac	40Vac, 200ms	Criterion C
		70% of 100Vac	70Vac, 500ms	Criterion C
		0% of 200Vac	0Vac, 20ms	Criterion A
		40% of 200Vac	80Vac, 200ms	Criterion A
		70% of 200Vac	140Vac, 500ms	Criterion A
Voltage interruptions	EN 61000-4-11	0% of 200Vac (=0V)	5000ms	Criterion C
Voltage sags	SEMI F47 0706	Dips on the input voltage according to SEMI F47 standard		
		80% of 120Vac (96Vac)	1000ms	Criterion A
		70% of 120Vac (84Vac)	500ms	Criterion A
		50% of 120Vac (60Vac)	200ms	Criterion A
Powerful transients	VDE 0160	Over entire load range	750V, 0.3ms	Criterion A

Performance criterions:

A: The device shows normal operation behavior within the defined limits.

C: Temporary loss of function is possible. The device may shut-down and restarts by itself. No damage or hazards for the device will occur.

EMC Emission

Conducted emission AC input lines	EN 55011, EN 55015, EN 55032, FCC Part 15, CISPR 11, CISPR 32	Class B
Conducted emission DC output lines	IEC/CISPR 16-1-2, IEC/CISPR 16-2-1	Limits for DC power port according EN 61000-6-3 fulfilled
Conducted emission DC OK Output		
Radiated emission	EN 55032 / EN 55011	Class B
Harmonics	EN 61000-3-2	Class A fulfilled between 0A and 12A load
Voltage fluctuations, flicker	EN 61000-3-3	Pass tested with constant current loads, non pulsing

This device complies with FCC Part 15 rules.

Operation is subjected to following two conditions: (1) this device may not cause harmful interference, and (2) this device must accept any interference received, including interference that may cause undesired operation..

Switching Frequencies

PFC converter	20kHz to 135kHz	Input voltage and output load dependent
Main converter	60kHz to 140kHz	Output load dependent
Auxiliary converter	54kHz to 66kHz	Output load dependent
Microcontroller clocks	48Mhz and 32MHz	Fixed frequency

16. Environment

Operational temperature	-25°C to +70°C (-13°F to 158°F)	Operational temperature is the same as the ambient or surrounding temperature and is defined as the air temperature 2cm below the unit.
Storage temperature	-40°C to +85°C (-40°F to 185°F)	For storage and transportation
Output de-rating	6W/°C 10W/°C 20W/1000m or 5°C/1000m	Between +45°C and +55°C (113°F to 131°F) Between +55°C and +70°C (131°F to 140°F) For altitudes >2000m (6560ft), see Fig. 16-2: Output power vs. altitude The de-rating is not hardware controlled. The user has to take this into consideration to stay below the de-rated current limits in order not to overload the unit.
Humidity	5 to 95% r.h.	According to IEC 60068-2-30
Atmospheric pressure	54-110kPa	see Fig. 16-2: Output power vs. altitude for details
Altitude	Up to 5000m (16 400ft)	see Fig. 16-2: Output power vs. altitude for details
Over-voltage category	III II	According to IEC 60664-1 For TN, TT mains systems with earthed neutral and IT star mains systems with insulation monitoring for altitudes up to 2000m According to IEC 60664-1 For TN, TT mains systems with earthed neutral and IT star mains systems with insulation monitoring for altitudes between 2000m and 5000m According to IEC 60664-1 For TN, TT, IT Delta mains systems or IT star mains systems without insulation monitoring for altitudes up to 2000m
Degree of pollution	3	According to IEC 62477-1, not conductive
Vibration sinusoidal	2-17.8Hz: ±1.6mm; 17.8-500Hz: 2g 2 hours / axis	According to IEC 60068-2-6
Shock	30g 6ms, 20g 11ms 3 bumps / direction, 18 bumps in total Shock and vibration is tested in combination with DIN-Rails according to EN 60715 with a height of 15mm and a thickness of 1.3mm and standard orientation.	According to IEC 60068-2-27
LABS compatibility	Yes	
Audible noise	Some audible noise may be emitted from the power supply during no load, overload or short circuit.	

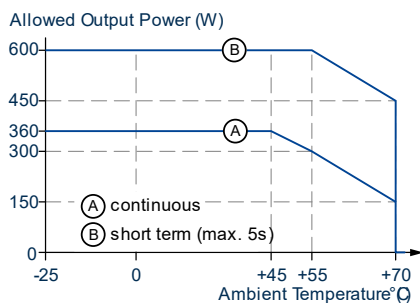

Fig. 16-1: Output power vs. ambient temp.

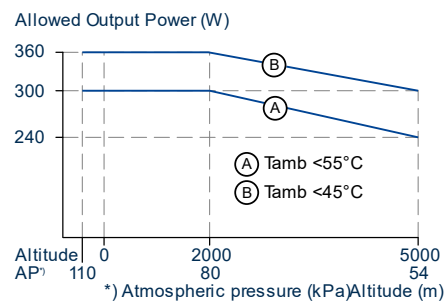

Fig. 16-2: Output power vs. altitude

All parameters are specified at 24V, 12.5A, 230Vac, 25°C ambient and after a 5 minutes run-in time unless otherwise noted.

17. Safety and Protection Features

Isolation resistance	min.	500MΩ	At delivered condition between input and output, measured with 500Vdc
	min.	500MΩ	At delivered condition between input and PE, measured with 500Vdc
PE resistance	max.	0.1Ω	Resistance between PE terminal and the housing
Input/Output separation		PELV	IEC/EN/UL 61010-2-201, IEC/EN 62368-1, IEC/EN 60950-1
Output over-voltage protection	typ.	31.8Vdc	In case of an internal defect, a redundant circuit limits the maximum output voltage. The output shuts down and automatically attempts to restart
	max.	32.5Vdc	
Class of protection			According to IEC 61140 A PE (Protective Earth) connection is required
Ingress protection		IP 65/67	According to EN/IEC 60529
Over-temperature protection		Included	Output shut-down with automatic restart. Temperature sensors are installed on critical components inside the unit and turn the unit off in safety critical situations, which can happen e.g. when ambient temperature is too high, ventilation is obstructed or the de-rating requirements are not followed. There is no correlation between the operating temperature and turn-off temperature since this is dependent on input voltage, load and installation methods.
Input transient protection		MOV (Metal Oxide Varistor)	For protection values, see chapter 22.2, EMC.
Internal input fuse		Included	Not user replaceable slow-blow high-braking capacity fuse
Touch current (leakage current)	max.	0.51 mA _{rms}	At 264Vac, 60Hz

18. Dielectric Strength

The negative potential of the outputs is permanently connected to PE within the unit. The output is insulated from the input by a double or reinforced insulation.

Type and routine tests are conducted by the manufacturer. Field tests may be conducted in the field using the appropriate test equipment which applies the voltage with a slow ramp (2s up and 2s down). Connect all input-terminals before conducting the test. When testing, set the cut-off current settings to the value in the table below.

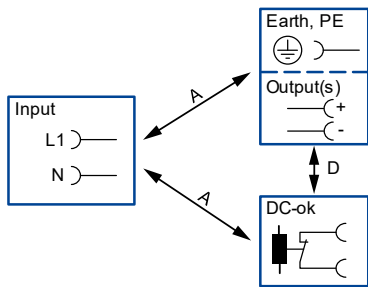





Fig. 18-1: Dielectric strength

		A	D
Type test	60s	2500Vac	500Vac
Routine test	5s	2500Vac	500Vac
Field test	5s	2000Vac	500Vac
Cut-off current setting for field test		> 10mA	> 10mA

19. Approvals and Fulfilled Standards (Pending)

IEC 62368-1	IECEE CB SCHEME	CB Scheme Certificate IEC 62368-1 - Audio/video, information and communication technology equipment - Safety requirements Output safety level: ES1
IEC 61010	IECEE CB SCHEME	CB Scheme Certificate IEC 61010-2-201 - Electrical Equipment for Measurement, Control and Laboratory Use - Particular requirements for control equipment
IEC 60950-1		Manufacturers Declaration IEC 60950-1 - General safety requirements for Information Technology Equipment (ITE)
UL 61010		UL Certificate Listed equipment for category NMTR - UL 61010-2-201 - Electrical equipment for measurement, control and laboratory use - Particular requirements for control equipment Applicable for US and Canada E-File: <UL_61010_2_201_Certificate>
Semi F47	SEMI F47	Test Report Voltage Sag Immunity for Semiconductor Processing Equipment Tested for AC 208V L-L or L-N mains voltages, nominal output voltage and nominal output load
VDMA 24364	LABS VDMA 24364-C1-L/W	Paint Wetting Impairment Substances Test (or LABS-Test) Tested for Zone 2 and test class C1 according to VDMA 24364-C1-L/W for solvents and water-based paints

20. Regulatory Compliance

EU Declaration of Conformity		Trade conformity assessment for Europe The CE mark indicates conformance with the European - EMC directive - Low-voltage directive (LVD) - RoHS directive
WEEE Directive		Manufacturer's Statement EU-Regulation on Waste Electrical and Electronic Equipment Registered in Germany as business to business (B2B) products.
REACH Directive	REACH ✓	Manufacturer's Statement EU-Regulation regarding the Registration, Evaluation, Authorisation and Restriction of Chemicals
RoHS-China		Manufacturer's Statement Administrative Measures for the Restriction of the Use of Hazardous Substances in Electrical and Electronic Products 25 years
IEC/EN 61558-2-16 (Annex BB)	Safety Isolating Transformer	Safety Isolating Transformers corresponding to Part 2-6 of the IEC/EN 61558

21. Accessories

21.1. DIN RAIL Mounting KIT: ZM.FP-DIN2

In addition to screw mounting FIEPOS has the option to be simply attached to a DIN rail.

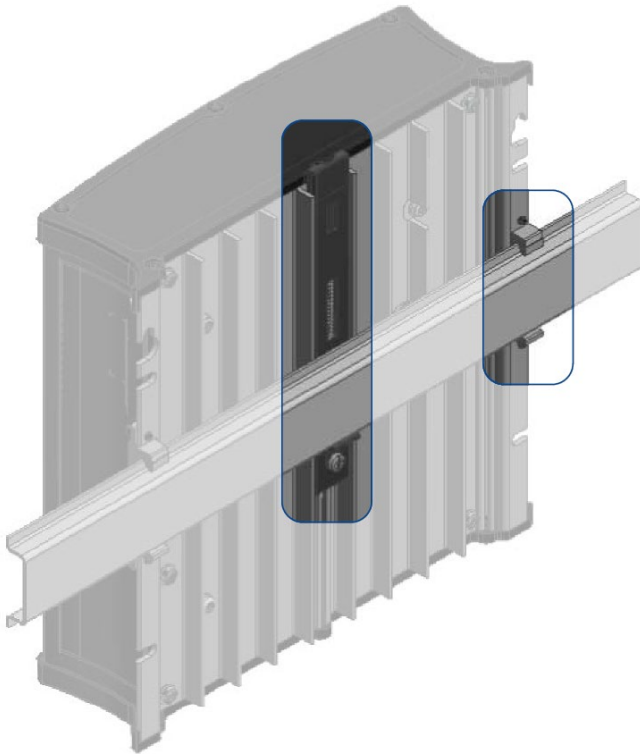

- DIN-Rail not included
- DIN-Fixture pre-assembled

21.2. Connectors

FIEPOS features a large number of different connectors. PULS provides all matching connectors from its own stock in order to be able to supply customers quickly in the design-in phase.

For a higher number of pieces or other options use the www.harting.com

Connector Name	Order number	Connector Description
Harting HanQ4/2	ZCF.hanq42	Q4/2 Set AS female 2.5-6mm ² 7-13mm
Harting HanQ4/2	ZCF.hanq42-1	Q4/2 Set AS female 2.5-6mm ² 14-17mm
Harting HanQ2/0	ZCM.hanq20	Q2/0 Set screw male 2.5-6mm ² 6-12mm
Harting HanQ4/0	ZCM.hanq40	Q4/0 Set 1m cable 2,5mm ² IP67
Harting HanQ5/0	ZCF.hanq50	Q5/0 Set QuickLock female 0.5-2.5mm ² 6-12mm
Harting M12-A	ZCF.m12a5p	M12-A 5pin cut clamp female 0.34-0.5mm ² / 6-8mm
Harting M12-A	ZCM.m12a5p	M12-A 5pin cut clamp male 0.34-0.5mm ² / 6-8mm
Harting M12-S	ZCF.m12s4p	M12-S 4pin screw female 2.5mm ² / 6-8mm
Harting M12-L	ZCM.m12l5p	M12-L 5pin cut clamp male 0.75-1.5mm ² / 5.8-13.5mm
Harting M12-T	ZCM.m12t4p	M12-T 4pin screw male 1.5mm ² / 8-10mm
Harting 7/8"	ZCM.78inch4p	7/8" 4pin screw male 1.5mm ² / 6-8mm
Harting 7/8"	ZCF.78inch3p	7/8" 3pin screw female 1.5mm ² / 6-8mm
Harting 7/8"	ZCF.78inch5p	7/8" 5pin screw female 0.75-1.5mm ² / 6.8-12.5mm

22. Related Products (PENDING)

The FIEPOS product family includes various devices with different technical parameters and features. The following page provides a general overview of the available solutions. Please also get in touch with your PULS contact person, for more detailed application advice and technical information.

23. Application Notes

23.1. Repetitive Pulse Loading

Typically, a load current is not constant and varies over time. This power supply is designed to support loads with a higher short-term power demand (=BonusPower®). The short-term duration is hardware controlled by an output power manager and is available on a repeated basis. If the average load is higher than the nominal output power, the output voltage will dip.

To avoid this, the following rules must be met:

- a) The power demand of the pulse must be below 200% of the nominal output power.
- b) The duration of the pulse power must be shorter than the allowed BonusPower® time. (see output section)
- c) The average power should be lower than the nominal output power.

The R.M.S. output current must be below the specified continuous output current. If the R.M.S. current is higher, the unit will respond with a thermal shut-down after a period of time.

23.2. External Input Protection (Pending)

The device is designed, tested and approved for branch circuits up to 30A (UL) and 32A (IEC) without additional protection device. If an external fuse is utilized, do not use circuit breakers smaller than 30A B- or C-Characteristic to avoid a nuisance tripping of the circuit breaker.

23.3. Inductive and Capacitive Loads

The unit is designed to supply any kind of loads, including capacitive and inductive loads. If extreme large capacitors, such as EDLCs (electric double layer capacitors or "UltraCaps") with a capacitance larger than 100mF are connected to the output, the unit might charge the capacitor in the HiccupPLUS mode (see chapter).

23.4. Back Feeding Loads

Loads such as decelerating motors and inductors can feed voltage back to the power supply. This feature is also called return voltage immunity or resistance against Back- E.M.F. (Electro Magnetic Force).

This power supply is resistant and does not show malfunctioning when a load feeds back voltage to the power supply. It does not matter whether the power supply is on or off.

23.5. Mounting Orientations

The device can be mounted in various mounting orientations. The listed lifetime and MTBF values from this datasheet apply only for the standard mounting orientation. The following curves give an indication for allowed output power in different mounting orientations for altitudes up to 2000m (6560ft).

A

Standard Orientation

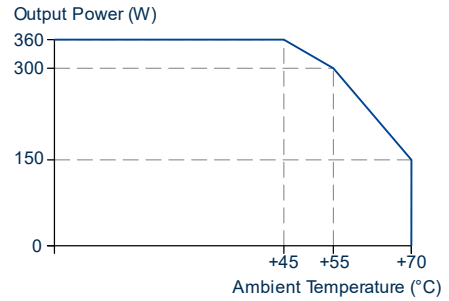
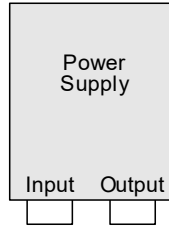

B

Upside down

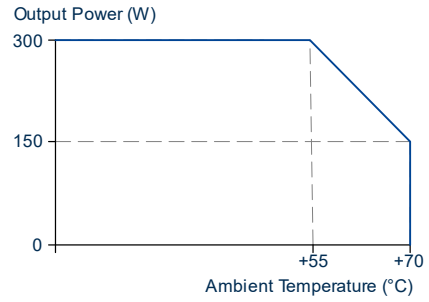
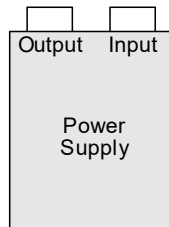

Horizontal cw and ccw



Over-head and Table-top mounting

