



## PRODUCT DESCRIPTION

**PLANET** power supplies are the top-of-the-line industrial grade DIN rail power supplies from PULS. Compact size, high efficiency and dynamic BonusPower capabilities make the **PLANET** power supplies stand out.

Thanks to the integrated **dynamic BonusPower management**, the power supply can adapt to varying power demands in real-time. By continuously monitoring the power output, it can provide extra power for different durations. For example, the power supply can deliver 130 % of its rated power for 22 s or up to 200 % for 5 s at temperatures up to +60 °C. At temperatures up to +45 °C, it can continuously provide 120 % of its rated power.

The high efficiency from stand-by to full load reduces total cost of ownership and carbon dioxide emissions, with particularly low power losses during no-load conditions.

Robust against back-feeding events, **PLANET** power supplies minimise downtime and ensure safety and reliability with Hiccup<sup>PLUS</sup> mode in case of overload.

The **PLANET TP** series combines these features in highly reliable and elegantly designed DIN rail power supplies. The **TP960.241** model is equipped with quick connector push-in terminals which can be used for all types of wires and enable quick installation.

The LED bar directly displays the power load of connected equipment.

The DC OK and AC OK relay contacts enable remote diagnostics.

## ORDER NUMBERS

<b>Power Supply</b>	TP960.241
<b>Accessory:</b>	ZM10.WALL Wall / panel mount bracket

## DIN RAIL POWER SUPPLY

- Compact width: Only 79 mm
- Efficiency 97.1 % at 24 V, 40 A
- Power losses at no load: 3.1 W
- Dynamic BonusPower management: Max. 1920 W for up to 15 s and 1152 W continuous (up to +40 °C, see Dynamic BonusPower Management)
- Enhanced Hiccup<sup>PLUS</sup> protects connected systems and power supply from overload
- AC OK and DC OK relay contacts
- Active current share bus for constant output voltage in parallel use
- Output voltage adjustable in six steps
- LED bar for visual monitoring the output power

## SHORT-FORM DATA

Output voltage	DC 24 V	nominal
Adjustment range	24 - 28 Vdc	six step adjustable settings
Output current	48 - 41.1 A 40 - 34.3 A 30 - 25.7 A	up to +45 °C up to +60 °C at +70 °C
short term (15 s)	80 A	up to +40 °C
Derating	linearly 12.8 W/K linearly 24 W/K	+45 °C to +60 °C +60 °C to +70 °C
Input voltage AC	3AC 380 - 500 V	-15 / +10 %
Input current AC	1.55 / 1.24 A	at 3x 400 / 500 Vac
Power factor	0.93 / 0.92	at 3x 400 / 500 Vac
Inrush current AC	no inrush current peak	
Efficiency	97.1 / 97 %	at 3x 400 / 500 Vac
Power losses	28 / 29 W	at 3x 400 / 500 Vac
Hold-up time	31 / 31 ms	at 3x 400 / 500 Vac
Temperature range	-40 °C to +70 °C	
Size (w x h x d)	79x124x136 mm	without DIN rail
Weight	1100 g	

## MAIN APPROVALS

For details and the complete approval list, see chapter 25.

## Index

1	Intended Use.....	3	15	MTBF.....	14
2	Installation Instructions.....	3	16	Functional Diagram.....	15
3	AC Input.....	4	17	Terminals and Wiring.....	16
4	External Input Protection.....	5	18	Front Side and User Elements.....	17
5	DC Input.....	5	19	Status LED Signaling.....	17
6	Input Inrush Current.....	5	20	EMC.....	18
7	Output.....	6	21	Environment.....	19
8	Hold-up Time.....	10	22	Protection Features.....	20
9	DC OK Relay Contact.....	10	23	Safety Features.....	20
10	AC OK Relay Contact.....	11	24	Dielectric Strength.....	21
11	Current Share Bus.....	12	25	Approved, Fulfilled or Tested Standards.....	22
12	Internal Data Logging.....	12	26	Regulatory Product Compliance.....	22
13	Efficiency and Power Losses.....	13	27	Physical Dimensions and Weight.....	23
14	Lifetime Expectancy.....	14			

The information given in this document is correct to the best of our knowledge and experience at the time of publication. If not expressly agreed otherwise, this information does not represent a warranty in the legal sense of the word. As the state of our knowledge and experience is constantly changing, the information in this data sheet is subject to revision. We therefore kindly ask you to always use the latest issue of this document (available under [www.pulspower.com](http://www.pulspower.com)).

No part of this document may be reproduced or utilised in any form without our prior permission in writing.

Packaging and packaging aids can and should always be recycled. The product itself may not be disposed of as domestic refuse.

## Terminology and Abbreviation

<b>PE and <math>\oplus</math> Symbol</b>	PE is the abbreviation for <b>Protective Earth</b> and has the same meaning as the symbol $\oplus$ .
<b>Earth, Ground</b>	This document uses the term "earth" which is the same as the U.S. term "ground".
<b>t.b.d.</b>	To be defined, value or description will follow later.
<b>3AC 500 V</b>	A figure displayed with the AC or DC before the value represents a nominal voltage with standard tolerances (usually $\pm 15\%$ ) included. E.g.: DC 12 V describes a 12 V battery disregarding whether it is full (13.7 V) or flat (10 V)
<b>3x 500 Vac</b>	A figure with the unit (Vac) at the end is a momentary figure without any additional tolerances included.
<b>50 Hz vs. 60 Hz</b>	As long as not otherwise stated, AC 380 V and AC 500 V parameters are valid at 50 Hz mains frequency. AC 500 V parameters are valid for 60 Hz mains frequency.
<b>may</b>	A key word indicating flexibility of choice with no implied preference.
<b>shall</b>	A key word indicating a mandatory requirement.
<b>should</b>	A key word indicating flexibility of choice with a strongly preferred implementation.

## 1. Intended Use

This device is designed for installation in an enclosure and is intended for commercial use, such as in industrial control, process control, monitoring and measurement equipment or the like.

Do not use this device in equipment where malfunction may cause severe personal injury or threaten human life.

If this device is used in a manner outside of its specification, the protection provided by the device may be impaired.

## 2. Installation Instructions

**⚠ DANGER Risk of electrical shock, fire, personal injury or death.**

- Turn power off before working on the device. Protect against inadvertent re-powering.
- Do not open, modify or repair the device.
- Use caution to prevent any foreign objects from entering the housing.
- Do not use in wet locations or in areas where moisture or condensation can be expected.
- Do not touch during power-on, and immediately after power-off. Hot surfaces may cause burns.

### Obey the following installation instructions:

This device may only be installed and put into operation by qualified personnel. This device does not contain serviceable parts. The tripping of an internal fuse is caused by an internal defect. If damage or malfunction should occur during installation or operation, immediately turn power off and send unit to the factory for inspection.

Install device in an enclosure providing protection against electrical, mechanical and fire hazards.

The device is designed, tested and approved for branch circuits up to 32A (UL) and 32A (IEC). An external circuit breaker is required. Do not use circuit breakers smaller than 6A B- or C-characteristic to avoid a nuisance tripping of the circuit breaker.

Install the device onto a DIN rail according to EN 60715 with the input terminals on the bottom of the device. Other mounting orientations require a reduction in output current.

Make sure that the wiring is correct by following all local and national codes. Use appropriate copper cables that are designed for the maximum operating temperature in the application. Ensure that all strands of a stranded wire enter the terminal connection. Use ferrules for wires on the input terminals. The device is designed for pollution degree 2 areas in controlled environments. No condensation or frost is allowed.

The enclosure of the device provides a degree of protection of IP20. The enclosure does not provide protection against spilled liquids.

For TN, TT mains systems with earthed neutral and IT star mains systems with insulation monitoring the device is designed for overvoltage category III zones up to 2000 m and for overvoltage category II zones up to 5000 m. For TN, TT, IT delta mains systems or IT star mains systems without insulation monitoring the device is intended for overvoltage category II zones up to 2000 m.

The device is designed for convection cooling and does not require an external fan. Do not obstruct airflow and do not cover ventilation grid!

The device is designed for altitudes up to 5000 m. Above 2000 m a reduction in output current of 2.5 A per 1000 m is required and the operation is limited according the mains systems description above.

Keep the following minimum installation clearances: 30 mm on bottom, 40 mm on top, 5 mm left and right side. Increase the 5 mm to 15 mm in case the adjacent device is a heat source. When the device is permanently loaded with less than 50 %, the 5 mm can be reduced to zero.

The maximum surrounding air temperature is +70 °C. The operational temperature is the same as the ambient or surrounding air temperature and is defined 3 cm below the device.

The device is designed to operate in areas between 5 % and 95 % relative humidity.

### 3. AC Input

The device is suitable to be supplied from TN-, TT-, IT- or corner grounded delta mains networks with AC voltage.

AC input	nom.	3AC 380-500 Vac	
AC input range		3x 323-550 Vac	
Input to PE	max.	550 Vac	according to IEC 62103
Input frequency	nom.	50-60 Hz	± 6 %
Turn-on voltage	typ.	3x 305 Vac	steady-state value, see Fig. 3-1
Shut-down voltage	typ.	3x 275 Vac	steady-state value at 40 A load, see Fig. 3-1
External input protection	see recommendations in chapter 4		

		3AC 400 V	3AC 500 V	
Input current	typ.	1.55 A	1.24 A	at 24 V, 40 A, see Fig. 3-3
Power factor <sup>1)</sup>	typ.	0.93	0.92	at 24 V, 40 A, see Fig. 3-4
Start-up delay	typ.	1000 ms	1000 ms	see Fig. 3-2
Rise time	typ.	10 ms	10 ms	at 24 V, 40 A const. current load, 0 mF load capacitance, see Fig. 3-2
	typ.	15 ms	15 ms	at 24 V, 40 A const. current load, 40 mF load capacitance, see Fig. 3-2
Turn-on overshoot	max.	500 mV	500 mV	see Fig. 3-2

1) The power factor is the ratio of the true (or real) power to the apparent power in an AC circuit.

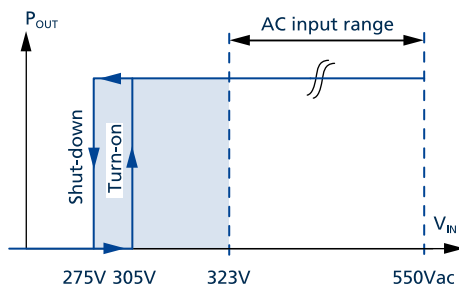

Fig. 3-1: Input voltage range

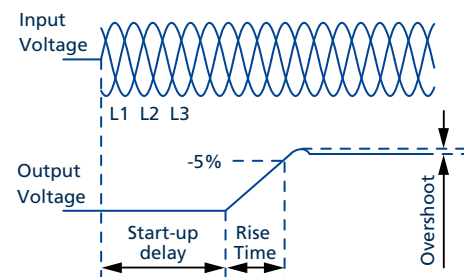

Fig. 3-2: Turn-on behavior, definitions

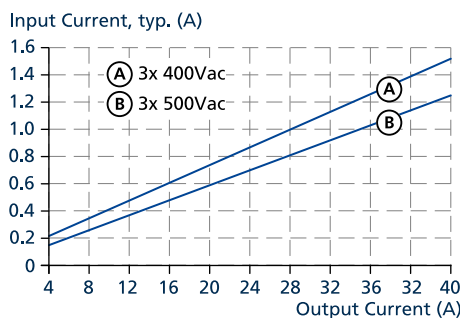

Fig. 3-3: Input current vs. output current at 24 V output voltage

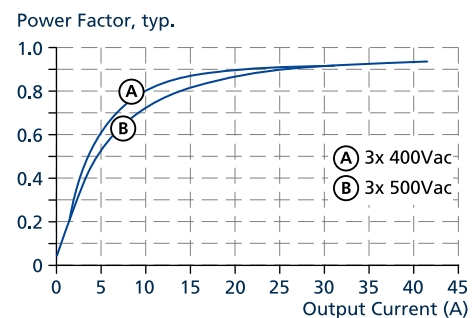

Fig. 3-4: Power factor vs. output current at 24 V output voltage

## 4. External Input Protection

The power supply is equipped with an active inrush current limitation circuit, which limits the input inrush current after turn-on to a negligible low value. The input current is usually smaller than the steady-state input current, see Fig. 3-1: Input voltage range.

## 5. DC Input

Do not operate this power supply with DC input voltage.

## 6. Input Inrush Current

The power supply has a control circuit that actively reduces the current to a level much lower than the steady-state input current. Therefore it has no inrush current peak.

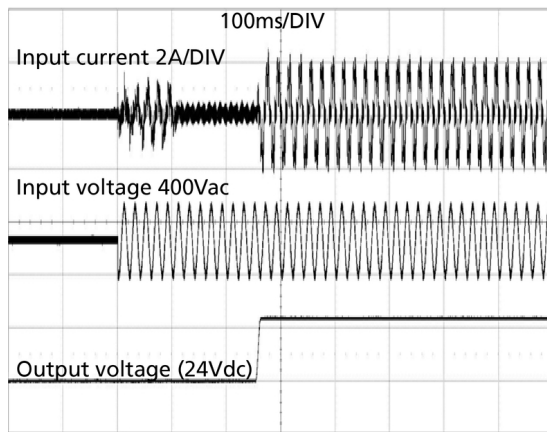

Fig. 6-1: Typical turn-on behaviour at nominal load and +25 °C ambient<sup>1</sup>

<sup>1</sup> The input current is usually smaller than the steady-state input current.

## 7. Output

Output voltage	nom.	24 Vdc	
Adjustment range		24-28 V	detent potentiometer with 6 settings 24 V, 25 V, 26 V, 26.5 V, 27 V, 28 V
Factory settings	max.	28 V	
	typ.	24 V	± 0.2 % using current share bus
Line regulation	max.	10 mV	between 3x 323 Vac and 550 Vac
Load regulation	max.	50 mV	between 0 A and 48 A, static value, see Fig. 7-1
Ripple and noise voltage	max.	50 mVpp	at 20 Hz to 20 MHz, 50 Ohm
Output current	nom.	40 A	at 24 V and up to +60 °C ambient temperature
	nom.	30 A	at 24 V and up to +70 °C ambient temperature
	nom.	34.3 A	at 28 V and up to +60 °C ambient temperature
	nom.	25.7 A	at 28 V and up to +70 °C ambient temperature
Derate linearly between +60 °C and +70 °C, see Fig. 21-1			
BonusPower continuous <sup>1)</sup>	nom.	48 A	at 24 V and up to +45 °C ambient temperature
	nom.	41.1 A	at 28 V and up to +45 °C ambient temperature
BonusPower continuous decreases linearly to nominal power between +45 °C and +60 °C, see Fig. 21-1			
Output power	nom.	960 W	continuously available
BonusPower continuous <sup>1)</sup>		1152 W	at 24 V, 48 A, up to +45 °C, continuous
BonusPower short term <sup>2)</sup>		1920 W	at 24 V, 80 A, up to +40 °C for short term 15 s or +60 °C for short term 5 s
Fuse breaking current	typ.	200 A	Up to 12 ms once every 5 s, see Fig. 7-2. The fuse breaking current is an enhanced transient current which helps to trip fuses on faulty output branches. The output voltage stays above 15 V.
Overload behaviour	Continuous current		for output voltage above 10 Vdc
	Hiccup <sup>PLUS</sup> mode <sup>3)</sup>		for output voltage below 10 Vdc
Overload / short-circuit current		80 A	Discharge current of output capacitors is not included.
Output capacitance	nom.	12 000 µF	included inside the power supply
Back-feeding loads	max.	35 V / 4 J	The unit is resistant and does not show malfunctioning when a load feeds back voltage to the power supply. It does not matter whether the power supply is on or off. The absorbing energy can be calculated according to the built-in large sized output capacitor.

<sup>1)</sup> **BonusPower continuous:**  
This power / current is continuously allowed up to an ambient temperature of +45 °C. Above +45 °C, do not use this power or current longer than a duty cycle of 10 % and / or not longer than 1 minute every 10 minutes.

<sup>2)</sup> **BonusPower short term:**  
The power supply is designed to support loads with a higher short-term power requirement without damage or shutdown.  
The short-term duration is hardware controlled by an output power manager. This power is repeatedly available.

<sup>3)</sup> **Hiccup<sup>PLUS</sup> mode:**  
At heavy overloads (when output voltage falls below 10 V), the power supply delivers continuous output current for 2 s. After this, the output is switched off for approx. 8 s before a new start attempt is automatically performed. This cycle is repeated as long as the overload exists. If the overload has been cleared, the device will operate normally, see Fig. 7-3.

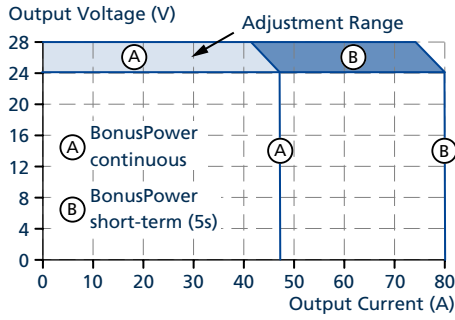

Fig. 7-1: Output voltage vs. output current, typ.

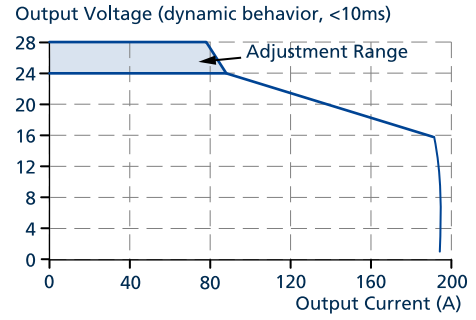

Fig. 7-2: Dynamic overcurrent capability, typ.

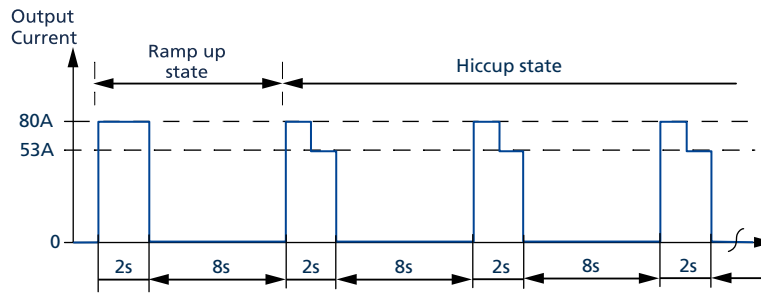

Fig. 7-3: Short-circuit on output, Hiccup<sup>PLUS</sup> mode, typ.

### Dynamic BonusPower Management

The power supply continuously monitors the power output through a power-time-integral. Therefore, BonusPower may be available longer than the maximum specified time if less BonusPower is utilised than the maximum allowed. Calculations assume the temperature stays at or below 45°C or 60°C, depending on the threshold.

BonusPower utilised	Time BonusPower is available (s) at ≤ +45 °C	Time BonusPower is available (s) at ≤ +60 °C
110 %	continuous	172.5
120 %	continuous	143.0
130 %	153.6	128.4
140 %	73.8	60.6
150 %	47.4	43.0
160 %	34.2	23.1
170 %	26.4	14.5
180 %	21.3	10.8
190 %	17.7	7.9
200 %	12.0	6.0

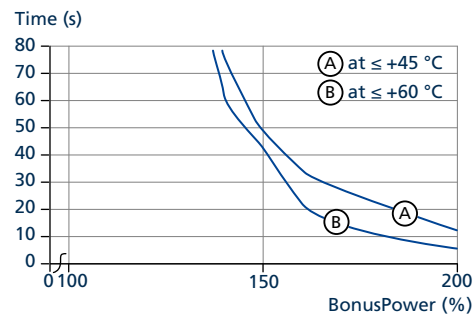

Fig. 7-4: Calculated time availability of BonusPower up to +60 °C

After operating at BonusPower, the power supply needs a cool-down period or recovery time. This can be calculated depending on the base load (<100 %) following the BonusPower period.

$$t_{\text{recover}} = \frac{P^2_{\text{BonusPower used}} - P^2_{\text{nominal power}}}{P^2_{\text{nominal power}} - P^2_{\text{base load}}} \times t_{\text{BonusPower used}}$$

#### Example:

Examples of recovery time after maximum BonusPower of 150 % was utilised for up to 15 seconds are displayed in the following table:

Base load	BonusPower time (s) at ≤ +45 °C				BonusPower time (s) at ≤ +60 °C				Recovery time (s)
	1 s	5 s	10 s	15 s	1 s	5 s	10 s	15 s	
0 %	0.56	2.81	5.63	8.44	1.25	6.25	12.5	18.75	
10 %	0.57	2.83	5.66	8.50	1.26	6.31	12.63	18.94	
20 %	0.58	2.89	5.79	8.68	1.30	6.51	13.02	19.53	
30 %	0.60	3.00	6.00	9.00	1.37	6.87	13.74	20.60	
40 %	0.63	3.16	6.33	9.49	1.49	7.44	14.88	22.32	
50 %	0.68	3.40	6.81	10.21	1.67	8.33	16.67	25.00	
60 %	0.75	3.75	7.50	11.25	1.95	9.77	19.53	29.30	
70 %	0.85	4.26	8.53	12.79	2.45	12.25	24.51	36.67	
80 %	1.01	5.06	10.13	15.19	3.47	17.36	34.72	52.08	
90 %	1.29	6.43	12.86	19.29	6.58	32.89	65.79	98.68	



Examples of recovery time after maximum BonusPower of 200 % was utilised for up to 15 seconds are displayed in the following table:

Base load	BonusPower time (s) at ≤ +45 °C				BonusPower time (s) at ≤ +60 °C				Recovery time (s)
	1 s	5 s	10 s	15 s	1 s	5 s	10 s	15 s	
0 %	1.78	8.89	17.78	26.67	3.00	15.00	30.00	45.00	
10 %	1.79	8.95	17.90	26.85	3.03	15.15	30.30	45.45	
20 %	1.83	9.14	18.29	27.43	3.13	15.63	31.25	46.88	
30 %	1.90	9.48	18.96	28.44	3.30	16.48	32.97	49.45	
40 %	2.00	10.00	20.00	30.00	3.57	17.86	35.71	53.57	
50 %	2.15	10.76	21.51	32.27	4.00	20.00	40.00	60.00	
60 %	2.37	11.85	23.70	35.56	4.69	23.44	46.88	70.31	
70 %	2.69	13.47	26.95	40.42	5.88	29.41	58.82	88.24	
80 %	3.20	16.00	32.00	48.00	8.33	41.67	83.33	125.00	
90 %	4.06	20.32	40.63	60.95	15.79	78.95	157.89	236.84	

## 8. Hold-up Time

The hold-up time is the time during which a power supply's output voltage remains within specification following the loss of input power. The hold-up time is output load dependent. At no load, the hold-up time can be up to several seconds. The green DC OK LED is also on during the hold-up time.

		3AC 400 V	3AC 500 V	
Hold-up time	typ.	60 ms	60 ms	at 24 V, 20 A, see Fig. 8-1
	min.	48 ms	48 ms	at 24 V, 20 A, see Fig. 8-1
	typ.	31 ms	31 ms	at 24 V, 40 A, see Fig. 8-1
	min.	20 ms	20 ms	at 24 V, 40 A, see Fig. 8-1

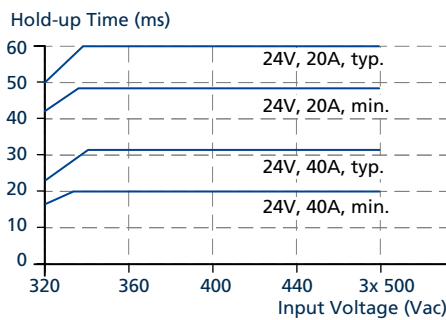

Fig. 8-1: Hold-up time vs. input voltage

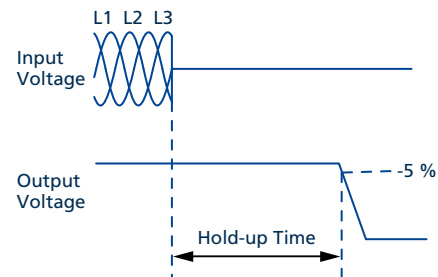

Fig. 8-2: Shut-down behaviour

## 9. DC OK Relay Contact

This feature monitors the output voltage, which is produced by the power supply itself. It is independent of a back-fed voltage from a unit connected in parallel to the power supply output.

Contact closes	As soon as the output voltage reaches typ. 90 % of the adjusted output voltage level.
Contact opens	As soon as the output voltage dips more than 10 % below the adjusted output voltage. Short dips will be extended to a signal length of 100 ms. Dips shorter than 1 ms will be ignored.
Switching hysteresis	typ. 2 V
Contact ratings	maximum 60 Vdc 0.3 A, resistive load minimum permissible load: 1 mA at 5 Vdc
Isolation voltage	see chapter 24, dielectric strength table

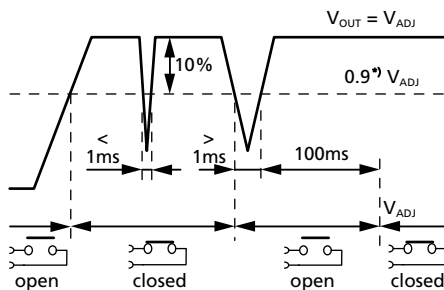

Fig. 9-1: DC OK relay contact behaviour

## 10. AC OK Relay Contact

The AC OK relay signals the status of the AC mains voltage at the input terminal. It is synchronised with the status LED.

Contact closes	As soon as all three line-to-line AC input voltages enter the rated input range, unless it is latched open. The latch condition is reset by disconnecting the power supply from AC and waiting until status LED changes from red to off (delay of typ. 800 ms after startup and 100 ms otherwise).
Contact opens	Either as soon as one or more line-to-line AC input voltages exits the rated input range due to undervoltage or overvoltage (delay of typ. 50 ms), or the difference of two line-to-line voltages becomes greater than 40 Vrms due to asymmetry (delay of typ. 500 ms). Short excursions are extended to a signal length of 100 ms (contact opened).
Contact latches open	Due to dynamic overvoltage, after 6 events within the last 60 minutes or 3 events within the last 5 minutes. The event counter is incremented also for short surges of high amplitude.
Switching hysteresis	25 V for undervoltage, 15 V for overvoltage, 20 V for asymmetry
Contact ratings	maximum 60 Vdc 0.3 A, resistive load minimum permissible load: 1 mA at 5 Vdc
Isolation voltage	see chapter 24, dielectric strength table

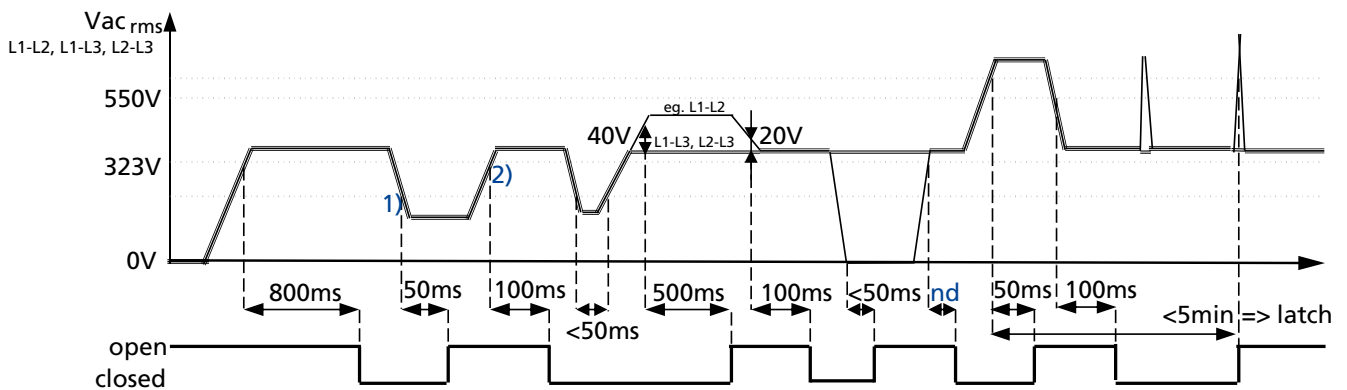

Fig. 10-1: AC OK relay contact behavior

- 1) At least 1 line-to-line voltage below low range minus hysteresis
- 2) All 3 line-to-line voltages above low range limit
- nd not defined

## 11. Current Share Bus

---

The current share bus distributes the current evenly for power supplies operating in parallel. It functions as an active current-sharing system, providing the advantage of maintaining a constant output voltage, regardless of the connected load.

To enable parallel operation, the bus-pins of each unit (pin 4.5 and 4.6) need to be daisy-chained, with the power return pins serving as the return path for the signal. This feature is especially beneficial for maintaining stable and consistent power output in parallel power supply configurations.

Make sure to adjust the output voltage potentiometer to the same values.

For detailed wiring, see chapter 17.

## 12. Internal Data Logging

---

A microcontroller inside the power supply acquires and stores operating data during the lifetime of the unit. The data can be retrieved by the PULS service and repair personnel, even when the unit is defect. The data allows for better troubleshooting in case of failure.

### Acquired data:

- Name of product series (TP960), revision of firmware
- Device configuration (such as output voltage setpoint, calibration data, etc.)
- Operational data:
  - Operating hours and remaining portion of lifetime
  - Maximum and minimum temperatures of semiconductors, capacitors and microcontrollers (values and counters)
  - Overtemperature event (counter)
  - Output voltage (min, max, value)
  - Output current (min, max, value)
  - Input voltage (rms min and max, value)
  - Input voltage (peak, max value)
  - Input voltage asymmetry (rms max, value and counter)
  - Input overvoltage events (individual line-to-line rms and transient, counters)
  - Input undervoltage sags (counter)
  - Input voltage line-to-line phase fail (counters)
- Number of turn-on sequences

### 13. Efficiency and Power Losses

		3AC 400 V	3AC 500 V	
Efficiency	typ.	97.1 %	97 %	at 24 V, 40 A
	typ.	96.9 %	96.9 %	at 24 V, 48 A (BonusPower continuous)
Average efficiency <sup>1)</sup>	typ.	96.8 %	96.4 %	25 % at 10 A, 25 % at 20 A, 25 % at 30 A, 25 % at 40 A
Power losses	typ.	3.1 W	2.5 W	at 24 V, 0 A
	typ.	15 W	16 W	at 24 V, 20 A
	typ.	28 W	29 W	at 24 V, 40 A
	typ.	37 W	37 W	at 24 V, 48 A (BonusPower continuous)

<sup>1)</sup> The average efficiency is an assumption for a typical application where the power supply is loaded with 25 % of the nominal load for 25 % of the time, 50 % of the nominal load for another 25 % of the time, 75 % of the nominal load for another 25 % of the time and with 100 % of the nominal load for the rest of the time.

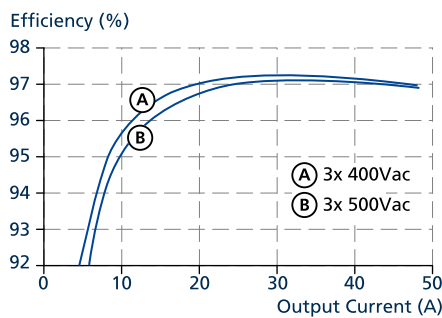

Fig. 13-1: Efficiency vs. output current at 24 V, typ.

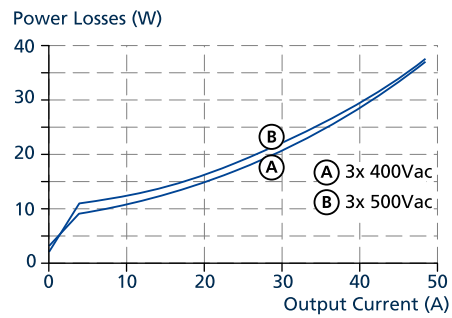

Fig. 13-2: Losses vs. output current at 24 V, typ.

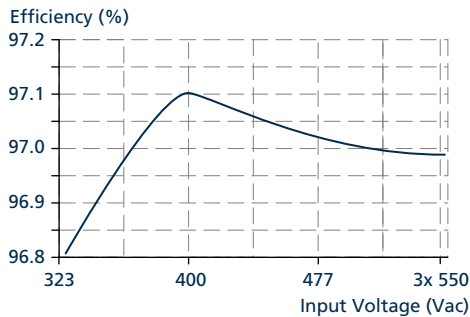

Fig. 13-3: Efficiency vs. input voltage at 24 V, 40 A, typ.

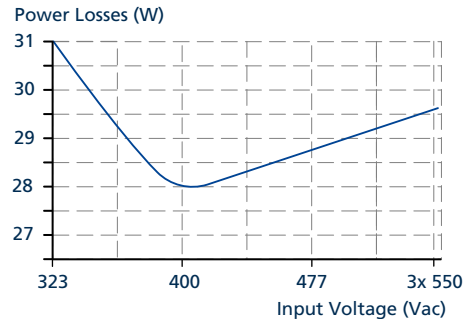

Fig. 13-4: Losses vs. input voltage at 24 V, 40 A, typ.

## 14. Lifetime Expectancy

The lifetime expectancy shown in the table indicates the minimum operating hours (service life) and is determined by the lifetime expectancy of the built-in electrolytic capacitors. Lifetime expectancy is specified in operational hours and is calculated according to the capacitor's manufacturer specification. The manufacturer of the electrolytic capacitors only guarantees a maximum life of up to 15 years (131 400 h). Any number exceeding this value is a calculated theoretical lifetime, which can be used to compare devices.

	3AC 400 V	3AC 500 V	
Lifetime expectancy	444 347 h	444 347 h	at 24 V, 20 A and +40 °C
	1 365 694 h	1 365 694 h	at 24 V, 20 A and +25 °C
	100 926 h	100 926 h	at 24 V, 40 A and +40 °C
	318 942 h	318 942 h	at 24 V, 40 A and +25 °C
	77 033 h	77 033 h	at 24 V, 48 A and +40 °C
	236 779 h	236 779 h	at 24 V, 48 A and +25 °C

## 15. MTBF

MTBF stands for **Mean Time Between Failures**, which is calculated according to statistical device failures, and indicates reliability of a device. It is the statistical representation of the likelihood of a unit to fail and does not necessarily represent the lifetime of a product.

The MTBF figure is a statistical representation of the likelihood of a device to fail. An MTBF figure of e.g. 1 000 000 h means that statistically one unit out of 10 000 installed units will fail every 100 h. However, it can not be determined if the failed unit has been running for 50 000 h or only for 100 h.

For these types of units the MTTF (**Mean Time To Failures**) value is the same value as the MTBF value.

	3AC 400 V	3AC 500 V	
MTBF SN 29500, IEC 61709	342 000 h	325 000 h	at 24 V, 40 A and +40 °C
	753 000 h	721 000 h	at 24 V, 40 A and +25 °C
MTBF MIL HDBK 217F	209 000 h	202 000 h	at 24 V, 40 A and +40 °C; Ground Benign GB40
	284 000 h	271 000 h	at 24 V, 40 A and +25 °C; Ground Benign GB25
	45 000 h	43 000 h	at 24 V, 40 A and +40 °C; Ground Fixed GF40
	59 000 h	58 000 h	at 24 V, 40 A and +25 °C; Ground Fixed GF25

## 16. Functional Diagram

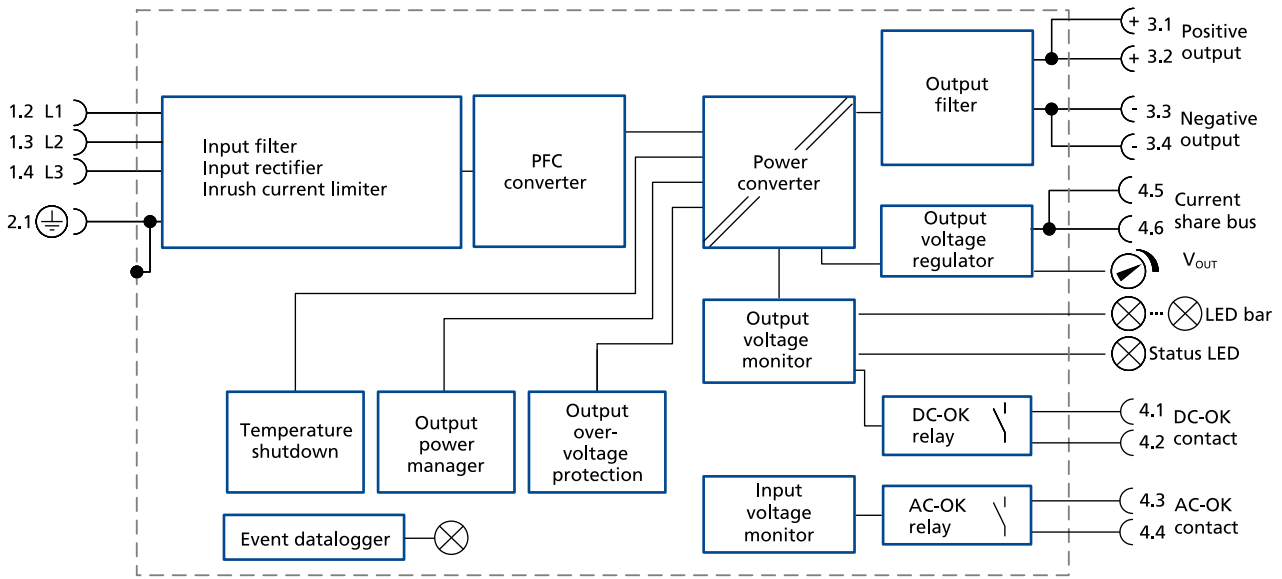

Fig. 16-1: Functional Diagram TP960.241

## 17. Terminals and Wiring

The terminals are IP20 finger safe constructed and suitable for field- and factory wiring.

	Input terminals	Output terminals	Signal terminals
Type	Spring clamp terminals	Spring clamp terminals + push-in functionality	Push-in terminals
Solid wire	max. 6 mm <sup>2</sup>	max. 16 mm <sup>2</sup>	max. 1.5 mm <sup>2</sup>
Stranded wire	max. 6 mm <sup>2</sup>	max. 16 mm <sup>2</sup>	max. 1.5 mm <sup>2</sup>
American wire gauge	AWG 20-10	AWG 20-6	AWG 28-14
Max. wire diameter (including ferrules)	3.6 mm	4.5 mm	1.5 mm
Wire stripping length	11 mm	19 mm	8 mm

### Instructions for wirings:

- Use appropriate copper cables that are designed for minimum operating temperatures of:
  - +60 °C for ambient up to +45 °C and
  - +75 °C for ambient up to +60 °C minimum
  - +90 °C for ambient up to +70 °C minimum.
- Follow national installation codes and installation regulations!
- Ensure that all strands of a stranded wire enter the terminal connection!
- Do not use the unit without PE connection.
- Unused terminal compartments should be securely tightened.
- Ferrules are allowed.

### Daisy chaining power path and current share bus:

The power supplies can operate in parallel to distribute the current evenly. This means that each power supply provides the same amount of current to the load. The current share bus has the advantage of keeping the output voltage constant, no matter how much load is connected.

When power supplies are connected in parallel, the share bus pins need to be daisy chained. Daisy chaining (paralleling power supplies by jumping from one power supply output to the next) is allowed as long as the average output current through one terminal pin does not exceed 51 A.

To enable parallel operation:

- ⇒ Adjust the output voltage potentiometer of each unit to the same value. The current-sharing system can compensate up to 0.4 V voltage difference, but it is better to have them as close as possible.
- ⇒ Connect the bus-pins of each unit (pin 4.5 and 4.6) with a wire. This creates an active current-sharing system that balances the current among the power supplies. The power return pins (pin 3.3 or 3.4) serve as the return path for the current-sharing signal.

If the current is higher, use a separate distribution terminal block as shown in Fig. 17-2.

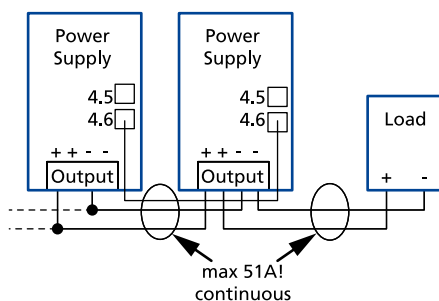

Fig. 17-1: Daisy chaining of outputs

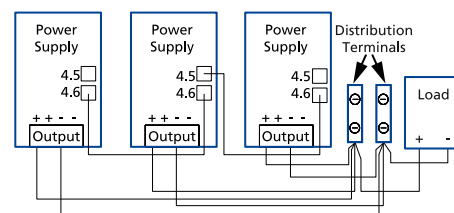

Fig. 17-2: Using distribution terminals



## 18. Front Side and User Elements

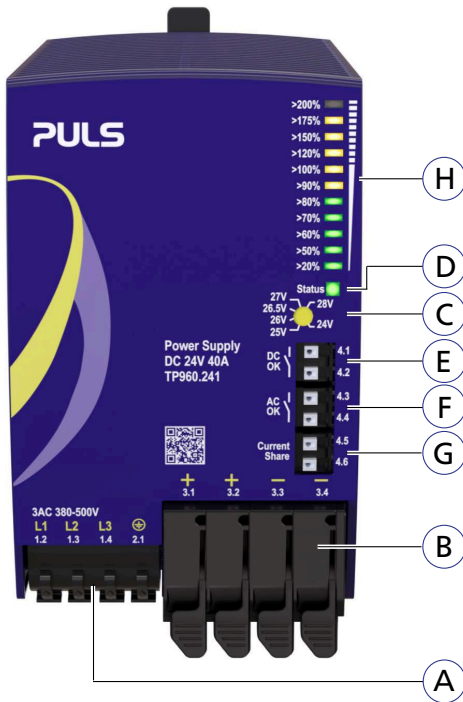

Fig. 18-1: Front side

- A Input terminals**
  - 1.2 L1
  - 1.3 L2 Line input
  - 1.4 L3
  - 2.1 PE (Protective Earth) input
- B Output terminals**  
Identical poles are internally connected.
  - 3.1 (+) Positive output
  - 3.2 (+)
  - 3.3 (-) Negative output (return)
  - 3.4 (-)
- C Output voltage potentiometer**  
Factory setting: 24 V  
User adjustable in 6 steps: 24 V, 25 V, 26 V, 26.5 V, 27 V, 28 V
- D Status LED**  
Green, when the output voltage is > 90 % of the adjusted output voltage.
- E DC OK relay contact**
  - 4.1 Open / The DC OK relay monitors the output
  - 4.2 close voltage. When the contact is closed, the
  - contact DC OK LED is on.
- F AC OK relay contact**
  - 4.3 Open / The AC OK relay monitors the AC input
  - 4.4 close voltage. In case of failure, the status LED
  - contact turns yellow.
- G Current share bus**
  - 4.5 The current share bus distributes the current evenly
  - 4.6 for power supplies operating in parallel.
- H LED bar**

## 19. Status LED Signaling

The status LED (D) displays different running conditions of the PSU in real-time.



- **Green**  
DC OK is above 90 % of output voltage. All outputs are operating according to their settings.
- **Yellow (steady on)**  
Various input voltage failures
- ⏏ **Yellow (blinking 1 Hz)**  
Pre-warning for overtemperature
- **Red (steady on)**  
AC input drop below the specified voltage, the output voltage turns off
- ⏏ **Red (blinking 1 Hz)**  
Hiccup<sup>PLUS</sup> mode or overtemp protection
- **Off**  
DC OK is below 90 % or power supply is not powered.

## 20. EMC

The device is designed for industrial environments. Do not use in residential, commercial and light-industrial environments. All results assume a 3-phase operation of the device.

EMC Immunity	According to generic standards: EN IEC 61000-6-1 and EN IEC 61000-6-2			
Electrostatic discharge	EN 61000-4-2	contact discharge	8 kV	Criterion A
		air discharge	15 kV	Criterion A
Electromagnetic RF field	EN 61000-4-3	80 MHz - 1 GHz	20 V/m	Criterion A
		1 GHz - 6 GHz	10 V/m	Criterion A
Fast transients (Burst)	EN 61000-4-4	input lines	4 kV	Criterion A
		output lines	2 kV	Criterion A
		DC OK signal (coupling clamp)	2 kV	Criterion A
		AC OK signal (coupling clamp)	2 kV	Criterion A
Surge voltage on input	EN 61000-4-5	L1 → L2, L2 → L3, L1 → L3	2 kV	Criterion A
		L1 / L2 / L3 → PE	4 kV	Criterion A
Surge voltage on output	EN 61000-4-5	(+) → (-)	1 kV	Criterion A
		(+) / (-) → PE	1 kV	Criterion A
Surge voltage on signals	EN 61000-4-5	DC OK signal → PE	1 kV	Criterion A
		AC OK signal → PE	1 kV	Criterion A
Conducted disturbance	EN 61000-4-6	0.15 - 80 MHz	20 V	Criterion A
Mains voltage dips	EN 61000-4-11	0 % of 380 Vac (0 Vac)	1 cycle	Criterion A
		0 % of 500 Vac (0 Vac)	1 cycle	Criterion A
		40 % of 380 Vac (152 Vac)	200 ms	Criterion A
		40 % of 500 Vac (200 Vac)	200 ms	Criterion A
		70 % of 380 Vac (266 Vac)	500 ms	Criterion A
		70 % of 500 Vac (350 Vac)	500 ms	Criterion A
Voltage interruptions	EN 61000-4-11	0 Vac	5000 ms	Criterion C
Voltage sags	SEMI F47 0706	dips on two phases according to section 7.2. of the SEMI F47 standard		
		80 % of 380 Vac (304 Vac)	1000 ms	Criterion A
		70 % of 380 Vac (266 Vac)	500 ms	Criterion A
		50 % of 380 Vac (190 Vac)	200 ms	Criterion A
Powerful transients	VDE 0160	over entire load range	1550 V, 1.3 ms	Criterion A

### Performance criterions:

- A:** Power supply shows normal operation behavior within the defined limits.
- B:** Device shows normal operation behavior within the defined limits. During burst or surge events small reduction of EtherCAT transmission rate is possible.
- C:** Temporary loss of function is possible. Power supply may shut-down and restarts by itself. No damage or hazards for the power supply will occur.

EMC Emission	According to generic standards: EN IEC 61000-6-3, EN IEC 61000-6-8 and EN IEC 61000-6-4		
Conducted emission input lines	EN 55011, EN 55032, FCC Part 15, CISPR 11, CISPR 32	Class B	
Conducted emission output lines	IEC/CISPR 16-1-2, IEC/CISPR 16-2-1	Limits for DC power ports according to EN 61000-6-8 are fulfilled.	
Radiated emission	EN 55011, EN 55032	Class B	
Harmonic input current	EN 61000-3-2	fulfilled for Class A equipment	
Voltage fluctuations, flicker	EN 61000-3-3	fulfilled with constant current loads, non pulsing	

This device complies with FCC Part 15 rules.

Operation is subjected to following two conditions: (1) this device may not cause harmful interference, and (2) this device must accept any interference received, including interference that may cause undesired operation.

<b>Switching Frequencies</b>	The power supply has three converters with three different switching frequencies included. One is nearly constant. The others are variable.	
PFC converter	20 kHz to 200 kHz	input voltage and output load dependent
Main converter	60 kHz to 140 kHz	output load dependent
Auxiliary converter	54-66 kHz	
Microcontroller clock	64 MHz	

## 21. Environment

Operational temperature <sup>1)</sup>	-40 °C to +70 °C	reduce output power according to Fig. 21-1
Storage temperature	-40 °C to +80 °C	for storage and transportation
Output derating	12.8 W/K 24 W/K 60 W / 1000 m or 5 °C / 1000 m	between +45 °C and +60 °C between +60 °C and +70 °C for altitudes > 2000 m, see Fig. 21-2
	The derating is not hardware controlled. The user has to take care by himself to stay below the derated current limits in order not to overload the unit.	
Humidity	5 - 95% r.h.	according to IEC 60068-2-30 Do not energize while condensation is present.
Atmospheric pressure	54 - 110 kPa	for details, see Fig. 21-2
Altitude	0 to 2000 m 2000 to 5000 m	without any restrictions reduce output power or ambient temperature, see Fig. 21-2.
Over-voltage category	III II	IEC/UL 61010-2-201 up to 2000 m IEC/UL 61010-2-201 2000 m to 5000 m
Degree of pollution	2	IEC/UL 61010-2-201, not conductive
Vibration sinusoidal	2 - 17.8 Hz: ±1.6 mm; 17.8 - 500 Hz: 2 g 2 hours / axis	IEC 60068-2-6
Shock	15 g 6 ms, 10 g 11 ms 3 bumps / direction, 18 bumps in total	IEC 60068-2-27
	Shock and vibration is tested in combination with DIN rails EN 60715 with a height of 15 mm and a thickness of 1.3 mm and standard orientation.	
Audible noise	Some audible noise may be emitted from the power supply during no load, overload or short circuit.	

<sup>1)</sup> The operational temperature is the same as the ambient or surrounding temperature. It is defined as the air temperature 3 cm below the device.

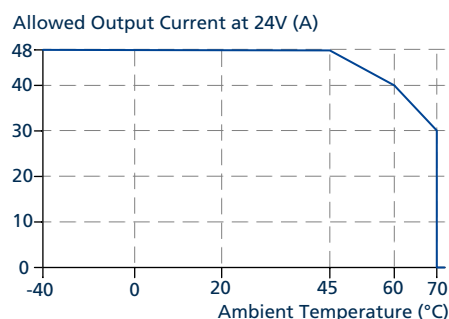

Fig. 21-1: Output current vs. ambient temp.

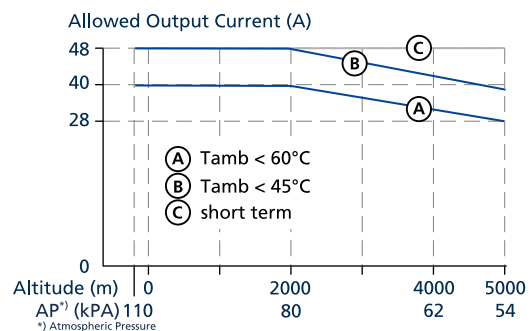

Fig. 21-2: Output current vs. altitude

## 22. Protection Features

Output overvoltage protection	typ. 30 Vdc max. 32 Vdc	In case of an internal power supply defect, a redundant circuit limits the maximum output voltage to 32 V . The output switches off and performs three restart attempts. If the failure continues, the output shuts down. Cycle input power to reset.
Degree of protection	IP20	EN/IEC 60529
Penetration protection	> 5 mm	e.g. screws, small parts
Overtemperature protection	included	output shut-down with automatic restart
Input transient protection	MOV (Metal Oxide Varistor)	for protection values, see chapter 20 (EMC)
Internal input fuse	included	not user replaceable

## 23. Safety Features

Input / output separation	SELV PELV double or reinforced galvanic insulation	IEC/UL 61010-2-201 IEC/UL 61010-2-201
Class of protection	I	PE (Protective Earth) connection required
Isolation resistance	> 500 MOhm > 500 MOhm > 500 MOhm	at delivered condition between input and output, measured with 500 Vdc at delivered condition between input and PE, measured with 500 Vdc at delivered condition between output and PE, measured with 500 Vdc
PE resistance	< 0.1 Ohm	resistance between PE terminal and the housing in the area of the DIN rail mounting bracket
PE conductor current	typ. 0.56 mA typ. 0.87 mA	at 3x 380 Vac 50 Hz, TN-, TT-mains at 3x 500 Vac 50 Hz, TN-, TT-mains

## 24. Dielectric Strength

The output voltage is floating and has no ohmic connection to the ground.

Type and factory tests are conducted by the manufacturer. Field tests may be conducted in the field using the appropriate test equipment which applies the voltage with a slow ramp (2 s up and 2 s down). Connect all input-terminals together as well as all output poles before conducting the test. When testing, set the cut-off current settings to the value in the table below.

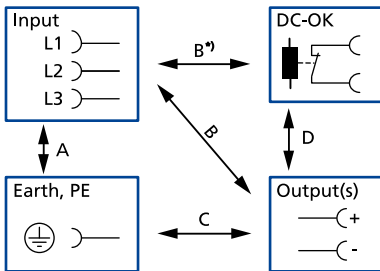

Fig. 24-1: Dielectric strength

	A	B	C	D
Type test (60 s)	4000 Vac	6000 Vac	1000 Vac	500 Vac
Factory test (5 s)	3600 Vac	5400 Vac	500 Vac	500 Vac
Field test (5 s)	2000 Vac	2000 Vac	500 Vac	500 Vac
Cut-off current setting for field test	> 10 mA	> 10 mA	> 20 mA	> 10 mA



To fulfil the PELV requirements according to EN 60204-1 § 6.4.1, we recommend that either the (+) pole, the (-) pole or any other part of the output circuit shall be connected to the protective earth system. This helps to avoid situations in which a load starts unexpectedly or can not be switched off when unnoticed earth faults occur.

**B\*)** When testing input to DC OK ensure that the max. voltage between DC OK and the output is not exceeded (column D). We recommend connecting DC OK pins and the output pins together when performing the test.

## 25. Approved, Fulfilled or Tested Standards

IEC 61010 (planned)	<b>Safety</b> ✓	Manufacturer's Declaration IEC 61010-2-201 - Electrical Equipment for Measurement, Control and Laboratory Use - Particular requirements for control equipment
Semi F47	<b>SEMI F47</b>	Test Report Voltage Sag Immunity for Semiconductor Processing Equipment

## 26. Regulatory Product Compliance

EU Declaration of Conformity	<b>CE</b>	The CE mark indicates conformance with the European <ul style="list-style-type: none"> <li>- EMC directive</li> <li>- Low-voltage directive (LVD)</li> <li>- RoHS directive</li> </ul>
REACH Regulation	<b>REACH</b> ✓	Manufacturer's Declaration EU Regulation regarding the Registration, Evaluation, Authorisation and Restriction of Chemicals EU Regulation 1907 / 2006
WEEE Regulation		Manufacturer's Declaration EU Directive on Waste Electrical and Electronic Equipment Registered in Germany as business to business (B2B) products. EU Directive 2012/19/EU WEEE-Reg.-Nr. DE 55837529
RoHS (China RoHS 2)		Manufacturer's Statement Administrative Measures for the Restriction of the Use of Hazardous Substances in Electrical and Electronic Products 25 years
IEC 61558-2-16 (Annex BB) (planned)	Safety Isolating Transformer	Test Certificate IEC 61558-2-16 - Safety of transformers, reactors, power supply units and similar products for supply voltages up to 1100 V. Particular requirements and tests for switch mode power supply units and transformers for switch mode power supply units.

## 27. Physical Dimensions and Weight

Width	79 mm
Height	124 mm
Depth	136 mm
	The DIN rail depth must be added to the unit depth to calculate the total required installation depth.
Weight	1100 g
DIN rail	Use 35 mm DIN rails according to EN 60715 or EN 50022 with a height of 7.5 or 15 mm.
Housing material	Body: Aluminium alloy Cover: Zinc-plated steel
Installation clearances (top / bottom / left / right)	40 / 40 / 5 / 5 mm

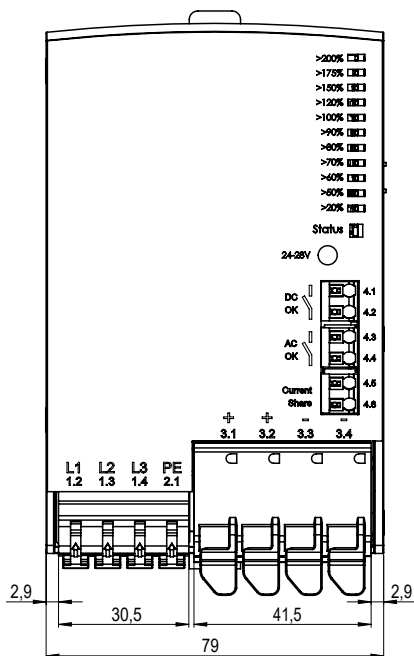

Fig. 27-1: Front view

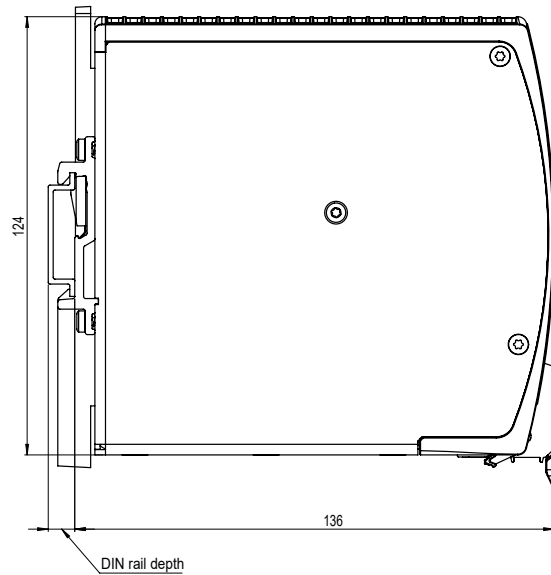

Fig. 27-2: Side view

All dimensions in mm unless otherwise noted.