

## Product Description

The SLZ13 is a mechanical adaptor to mount a DIN-rail device on a Siemens S7-300 mounting rail.

The order number SLZ13 contains one bracket and two screws needed to fix the adaptor onto the Siemens S7-300 rail.

## Intended Use

This mechanical adaptor is designed for DIN-rail devices with a specific unit width shorter than the bracket width.

## Technical Data

**Size** (width x height x depth) 90x124.7x19mm

**Weight** 180g / 0.4lb

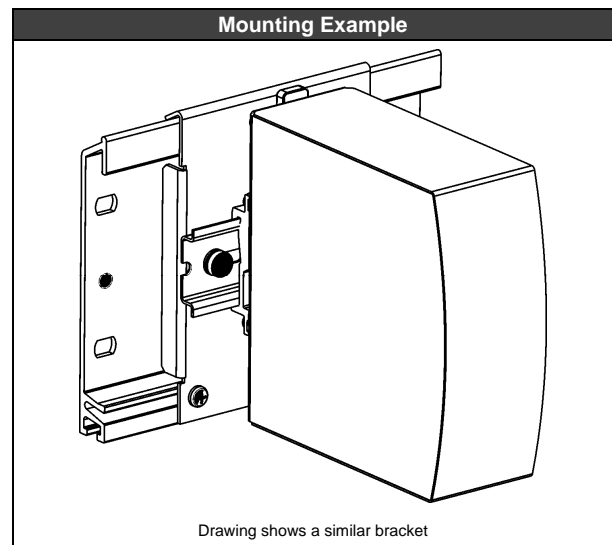
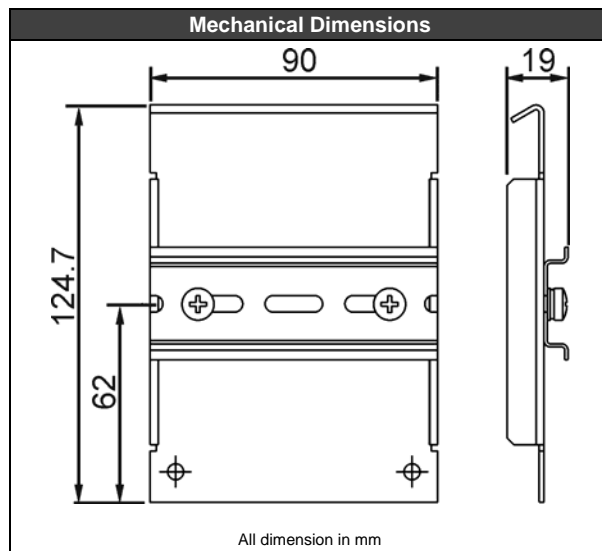

**Headquarters:** PULS GmbH, Elektrastr. 6, 81925 Munich, Germany, [www.pulspower.com](http://www.pulspower.com)

**Germany** +49 89 9278 0

**France** +33 478 668 941

**Austria** +43 2764 3213

**Switzerland** +41 56 450 18 10

**China** +86 512 62881820

**North America** +1 630 587 9780

**Singapore** +65 6684 2310

**United Kingdom** +44 1525 841001

The information in this document is believed to be accurate and reliable and may change without notice.

**Installation Instructions**

- 1) Click the adapter on any given place on the Siemens S7-300 mounting rail.
- 2) Insert the two module screws provided with the bracket and manually tighten the screws.
- 3) Click the DIN-rail device on the DIN-rail.

