

POWER SUPPLY 100-240Vac 24V 360W¹⁾

- IP 65/67 Degree of protection
- 360W up to 45°C
- AC 100-240V wide-range input
- Output OK
- 4 switchable outputs
- 600W_{peak} 5s
- Outputs for actors and sensors separately protected
- 95.7% full load and excellent partial load efficiencies
- Output connected to PE (PELV)
- Large output capacitors
- No potting compound used
- Negligible low input inrush current surge
- Full power between -25°C and +55°C
- DIN rail possible, with optional bracket
- 3 years warranty

¹⁾ 360W up to 45°C

GENERAL DESCRIPTION

The **FPS300** is an industrial grade power supply for the 1-phase mains system that is incorporated into a rugged wall-mount housing with an IP65/67 degree of protection.

It provides four stabilized outputs that are galvanically separated from the input. The negative terminals of the outputs are permanently connected to PE within the unit.

The most outstanding features of the FPS series are compact size, wide operating temperature range, extremely low input inrush current and very high efficiencies, which are achieved through various design topologies. The large output capacitors can absorb and store regenerative energy from breaking motors.

High immunity to transients and power surges as well as low electromagnetic emissions and an international approval package make it possible for nearly every application. The various connector options support the different needs of individual applications. Please contact PULS for possible options.

SHORT-FORM DATA

Output voltage	DC 24V	Nominal
Adjustment range	24-28V	Factory setting 24.5V
Output power	Continuous: 360 / 300 / 150W	Up to: +45 / +55 / +70°C
	Short term up to 5 s 600 / 300W	+55 / +70°C
Derate linearly	+55°C to +70°C	
Number of output	4	
Output currents	Settable per output; up to 10A	
Input voltage AC	AC 100-240V	-15 / +10%
Input voltage DC	DC 110-300V ²⁾	±20%
Power factor	0.99 / 0.97	At 120 / 230Vac
AC Inrush current	2.6 / 6A _{peak}	At 120 / 230Vac
Efficiency	94.3 / 95.7%	At 120 / 230Vac
Losses	18.1 / 13.5W	At 120 / 230Vac
Hold-up time	44 / 44ms	At 120 / 230Vac
Temperature range	-25°C to +70°C	
Size (wxhxd)	181x183x59mm	Without connectors
Weight	1200 g / 2.7 lb	

²⁾ For DC supply voltages above 150Vdc an external fuse is required.

ORDER NUMBERS

Description:	Power supply FPS300	
Order Number	Input	Output
FPS300.245-047-111	7/8" - 3pin	2x 7/8" - 4pin
Accessories:	Chapter 21	
Related Products	Chapter 22	

MAJOR APPROVALS AND CONFORMITY

For details or a complete approval list, see chapter 21.

CB Report



IEC 62368-1
IEC 61010-2-201

INDEX

INDEX	2	15. Environment	19
1. Intended Use	4	16. Safety and Protection Features.....	20
2. Installation Instructions	4	17. Dielectric Strength.....	21
3. AC-Input	5	18. Approvals and Fulfilled Standards.....	22
4. DC-Input	6	19. Regulatory Compliance	22
5. Input Inrush Current	6	20. Accessories	23
6. Output	7	20.1. DIN RAIL Mounting KIT: ZM.FPDRA-11	23
7. Hold-up Time	9	20.2. Mounting Bracket: ZM.FPMBA-11.....	23
8. Efficiency and Power Losses	10	20.3. Mating Connectors.....	23
9. Lifetime Expectancy.....	11	21. Application Notes.....	24
10. MTBF.....	11	21.1. Repetitive Pulse Loading.....	24
11. Functional Diagram	12	21.2. External Input Protection.....	24
12. Dimensions and Connector Variants.....	13	21.3. Inductive and Capacitive Loads	24
13. User Interface.....	14	21.4. Back Feeding Loads.....	24
14. EMC.....	17	21.5. Mounting Orientations.....	25

The information given in this document is correct to the best of our knowledge and experience at the time of publication. If not expressly agreed otherwise, this information does not represent a warranty in the legal sense of the word. As the state of our knowledge and experience is constantly changing, the information in this data sheet is subject to revision. We therefore kindly ask you to always use the latest issue of this document (available under www.pulspower.com).

No part of this document may be reproduced or utilized in any form without our prior permission in writing.

Packaging and packaging aids can and should always be recycled. The product itself may not be disposed of as domestic refuse.

TERMINOLOGY AND ABBREVIATIONS

PE and \oplus Symbol	PE is the abbreviation for Protective Earth and has the same meaning as the symbol \oplus .
Earth, Ground	This document uses the term "earth" which is the same as the U.S. term "ground".
T.b.d.	To be defined, value or description will follow later.
AC 230V	A figure displayed with the AC or DC before the value represents a nominal voltage with tolerances (usually $\pm 15\%$) included. E.g.: DC 12V describes a 12V battery disregarding whether it is full (13.7V) or flat (10V)
230Vac	A figure with the unit (Vac) at the end is a momentary figure without any additional tolerances included.
50Hz vs. 60Hz	As long as not otherwise stated, AC 100V and AC 230V parameters are valid at 50Hz mains frequency. AC 120V parameters are valid for 60Hz mains frequency.
May	A key word indicating flexibility of choice with no implied preference.
Shall	A key word indicating a mandatory requirement.
Should	A key word indicating flexibility of choice with a strongly preferred implementation.
Us	Sensor output
Ua	Actuators output

NOMENCLATURE

Detail	Description
FPT	380-480V 3 Phase IP54-67 Power Supply
FPS	100-240V 1 Phase IP54-67 Power Supply
FPH	200-240V 1 Phase IP54-67 Power Supply Highline Input Voltage
300	300W Power Class
500	500W Power Class
241 / 481	Standard Power Supply with Output Voltage 24-28V / 48-52V Setting and LED Bar
242 / 482	Basic Power Supply without Voltage Setting and LED-Bar. This version has a status LED Bar.
245 / 485	Power Supply with up to 4 E-Fuse Channels
246 / 486	Power Supply with up to 4 NEC Class II Channels
247 / 487	Power Supply with NEC Class II and E-Fuse Channel
0xx	Terminal configuration e.g. .002. Input: HanQ4/2 Com: M12-A Output: HanQ4/0
1xx	Consecutively numbered

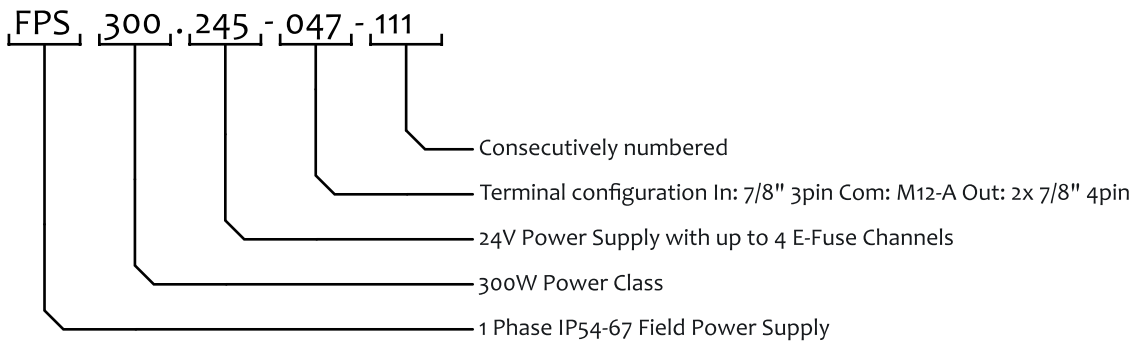

1. Intended Use

This device is designed for indoor use and is intended for commercial applications, such as in industrial control, process control, monitoring and measurement equipment.

Do not use this device in equipment where malfunction may cause severe personal injury or threaten human life. If this device is used in a manner outside of its specification, the protection provided by the device may be impaired.

2. Installation Instructions

⚠ DANGER Risk of electrical shock, fire, personal injury or death.

- Turn power off before working on the device. Protect against inadvertent re-powering.
- Do not open, modify or repair the device.
- Do not touch during power-on and immediately after power-off. Hot surfaces may cause burns.
- Install the device on a large enough flat surface. Sharp edges on the back may cause injury.
- If damages or malfunctioning occur during installation or operation, immediately turn power off and send unit to the factory for inspection.
- The device is designed as "Class of Protection I" equipment according to IEC 61140. Do not use without a proper PE (Protective Earth) connection.

⚠ WARNING Risk of damages on the device

- Keep the following minimum installation clearances: 30mm on top and bottom, 10mm on the front and 10mm left and right side.
- The maximum surrounding air temperature is +70°C (+158 °F). The operational temperature is the same as the ambient or surrounding air temperature and is defined 2cm below the device.
- The device is designed to operate in areas between 5% and 95% relative humidity.
- Clean only with a damp cloth.

Obey the following installation instructions:

This device may only be installed and put into operation by qualified personnel. This device does not contain serviceable parts. The tripping of an internal fuse is caused by an internal defect. Install the device onto a flat surface with the terminals on the bottom of the device. Other mounting orientations require a reduction in output power, chapter 23.6.

For wall mounting use 4 screws. Two on top and 2 on bottom mounting holes. Recommended screw size is M4 (UNC 8-32). The enclosure of the device provides a degree of protection of IP65/67 when installed with all mating connectors firmly connected. The device is designed for pollution degree 3 areas in controlled environments.

Assure that during installation no moisture or dirt gets into the connections. Operation in areas where moisture or condensation can be expected is possible.

The negative potential of the outputs is permanently connected to PE within the unit. Do not connect the negative potential of any output to PE outside the unit.

For TN,TT mains systems with earthed neutral and IT star mains systems with insulation monitoring the device is designed for overvoltage category III zones up to 2000 m (6560 ft) and for overvoltage category II zones up to 5000 m (16400 ft).

For TN, TT, IT delta mains systems or IT star mains systems without insulation monitoring the device is intended for overvoltage category II zones up to 2000 m (6560 ft).

The device is designed for altitudes up to 5000 m (16400 ft). Above 2000 m (6560 ft) a reduction in output current is required and the operation is limited according mains systems described above. The device is designed, tested and approved for branch circuits up to 20 A (UL) and 32 A (IEC) without additional protection device. If an external fuse is utilized, do not use circuit breakers smaller than 6 A B- or C-characteristic to avoid a nuisance trip. A disconnecting means shall be provided for the input of the device. This must be suitably located and easily accessible. The disconnecting means must be marked as the such for the device.

3. AC-Input

The device is suitable to be supplied from TN, TT or IT mains networks. For more details, please review chapter 2.

AC input voltage rated range	nom.	AC 100-240V	
AC input operating range		85-264Vac 264-300Vac	Continuous operation For maximal 500ms
Input frequency	nom.	50–60Hz	±6%
Turn-on voltage	typ.	80Vac	Steady-state value, see Fig. 3-1
Shut-down voltage	typ.	70Vac	Steady-state value, see Fig. 3-1
External input protection	See recommendations in chapter 2 .		

		AC 100V	AC 120V	AC 230V	
Input current	typ.	3.98A	3.2A	1.68A	At 360W, symmetrical phase voltages, see Fig. 3-3
Power factor ¹⁾	typ.	0.99	0.99	0.97	At 360W, see Fig. 3-4
Start-up delay	typ.	2.5s	2.5s	2.5s	At 300W symmetrical phase voltages, see Fig. 3-2
Rise time	typ.	22ms	22ms	22ms	At 300W constant current load, 0mF load, see Fig. 3-2
	typ.	48ms	46ms	35ms	At 300W constant current load, 12.5mF, see Fig. 3-2
Turn-on overshoot	max.	200mV	200mV	200mV	See Fig. 3-2

¹⁾ The power factor is the ratio of the true (or real) power to the apparent power in an AC circuit.

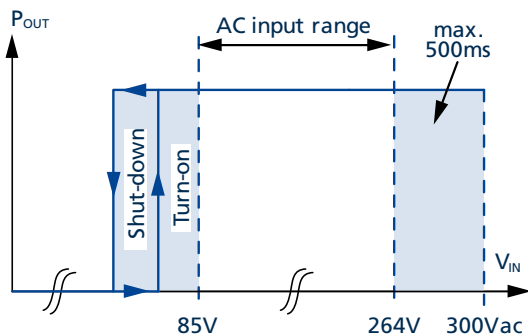

Fig. 3-1: Input voltage range

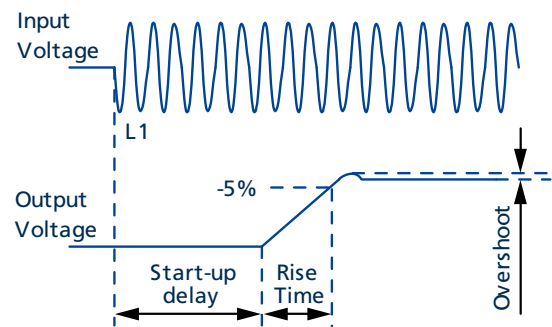

Fig. 3-2: Turn-on behavior, definitions

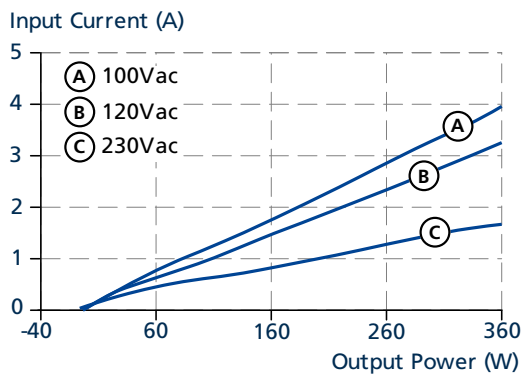

Fig. 3-3:
Input current vs. output power at 24V output voltage

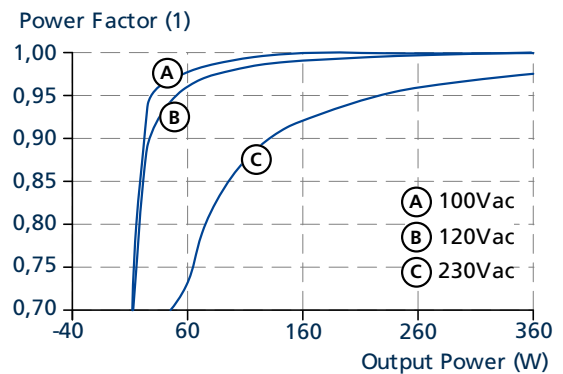

Fig. 3-4:
Power factor vs. output power at 24V output voltage

All parameters are specified at 24V, 12.5A, 230Vac, 25°C ambient and after a 5 minutes run-in time unless otherwise noted.

4. DC-Input

The device is suitable to be supplied from a DC input voltage.

DC input*)	nom.	DC 110-300V ¹⁾	±20%
DC input range	min.	88Vdc	
	max.	360Vdc	
DC input current	typ.	2.90A	At 110Vdc, at 24V, 300W
	typ.	1.04A	At 300Vdc, at 24V, 300W
Turn-on voltage	typ.	80Vac	
Shut-down voltage	typ.	70Vac	

¹⁾ For DC supply voltage above 150Vdc an external fuse with an appropriate rating is required. Wide range DC input 110-300V without external fuse on request.

Instructions for DC use:

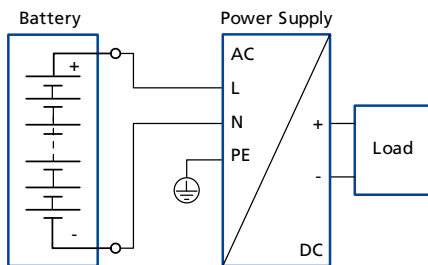

Fig. 4-1: Wiring for DC Input

- Use a battery or a similar DC source. A supply from the intermediate DC-bus of a frequency converter is not recommended and can cause a malfunction or damage the unit.
- Connect +pole to L and -pole to N.
- Connect the PE terminal to an earth wire or to the machine ground.

5. Input Inrush Current

An active inrush limitation circuit (NTCs, which are bypassed by a relay contact) limits the input inrush current after turn-on of the input voltage. The charging current into EMI suppression capacitors is disregarded in the first microseconds after switch-on.

Inrush current	max.	AC 100V	AC 120V	AC 230V
		2.18A _{peak}	2.6A _{peak}	6A _{peak}

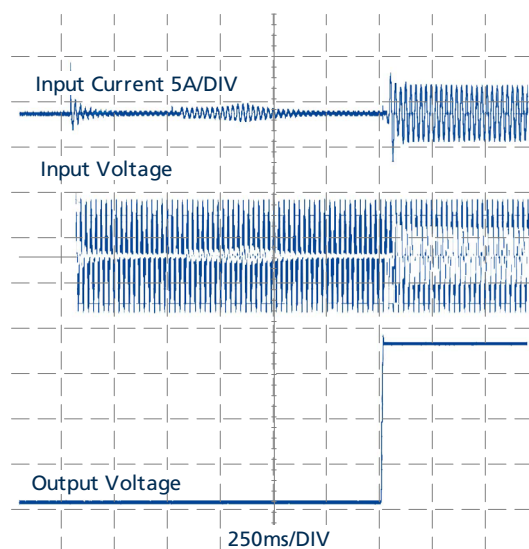

Fig. 5-1: Typical turn-on behavior at nominal load and 25°C ambient temperature

All parameters are specified at 24V, 12.5A, 230Vac, 25°C ambient and after a 5 minutes run-in time unless otherwise noted.

6. Output

The outputs provide a (PELV/ES1) rated voltage, which is galvanically isolated from the input voltage. The negative terminals of the outputs are permanently connected to PE within the unit. Do not connect any output to PE (Ground).

The device is designed to supply any type of loads, including capacitive and inductive loads. If capacitors with a capacitance >20mF are connected to one output, this output might switch off once the output is energized.

All outputs are individually current limited. In case of an overload, the individual output switches off and needs to be reset manually with the reset button on the front of the device. A cycling of the input power does not reset the output and the signal status is stored until a reset is intentionally initiated.

For protection reasons, a delay of at least 5 seconds is mandatory, before an output can be reset after it has been switched off. Otherwise, the green LED will flicker after pushing the button. The unit is shipped with all outputs turned on. The ON/OFF function has no safety function included.

The sum of the configured outputs may exceed the total output power, see Fig. 6-2. If this occurs, the output with the highest number will trip first, followed by the next lower output to ensure that the lower channels will supply continuous power and see no voltage dips.

Outputs start sequentially from 1 to 4 with an interval of 150ms, see Fig. 6-1.

Number of outputs		4	On two 7/8" - 4pin connectors
Output voltage	nom.	24V	Factory setting 24.5V
Adjustment range		24-28V	Front panel adjustable in increments: 24V, 24.5V, 25V, 25.5V, 26V, 26.5V, 27V and 28V
Factory setting	typ.	24.5V	±0.2%, at nominal load
	typ.	10A	Per channel Outputs turned on
Line regulation	max.	25mV	From 85 to 300Vac input voltage change
Load regulation	typ.	250mV	From 0 to 360W output load, static value
Ripple and noise voltage	max.	50mVpp	Bandwidth 20Hz to 20MHz, 50Ohm
Output current	max.	10A each output	Fig.
Total output power	nom.	360W	Up to +45°C at ambient temperatures, for the sum of all outputs.
	nom.	300W	At +55°C at ambient temperatures, for the sum of all outputs.
	nom.	150W	At +70°C at ambient temperatures, for the sum of all outputs.
short term up to 5s	nom.	600W	Up to +55°C at ambient temperatures, for the sum of all outputs.
	nom.	300W	At +70°C at ambient temperatures, for the sum of all outputs.
			Derate linearly between +55°C and +70°C
Overload behavior		Trip curve	See Fig. 6-3
Output capacitance	typ.	12 500µF	Included inside the power supply, common for all four outputs
Parallel Use			Do not parallel units for higher output currents
Back-feeding loads	max.	35V / 4J	The unit is resistant and does not show a malfunction when a load feeds back voltage to the power supply. It does not matter whether the power supply is on or off. Max voltage for all four outputs.

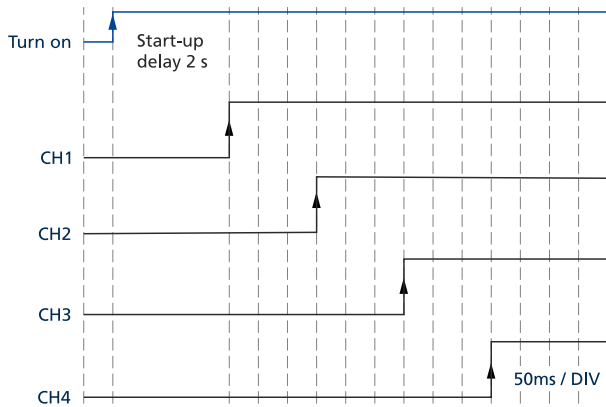

Fig. 6-1: Sequential start of the outputs

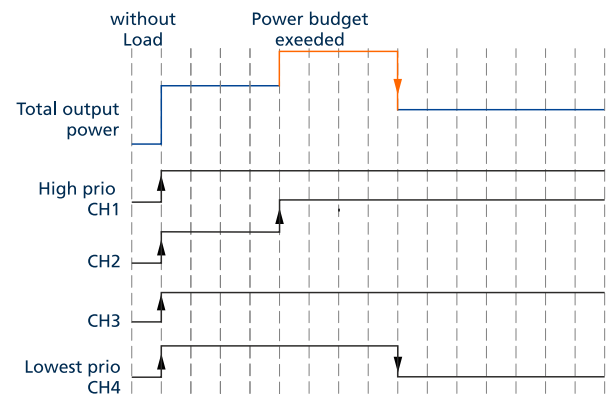

Fig. 6-2: Tripping of the channel with the lowest priority when the power budget is exceeded

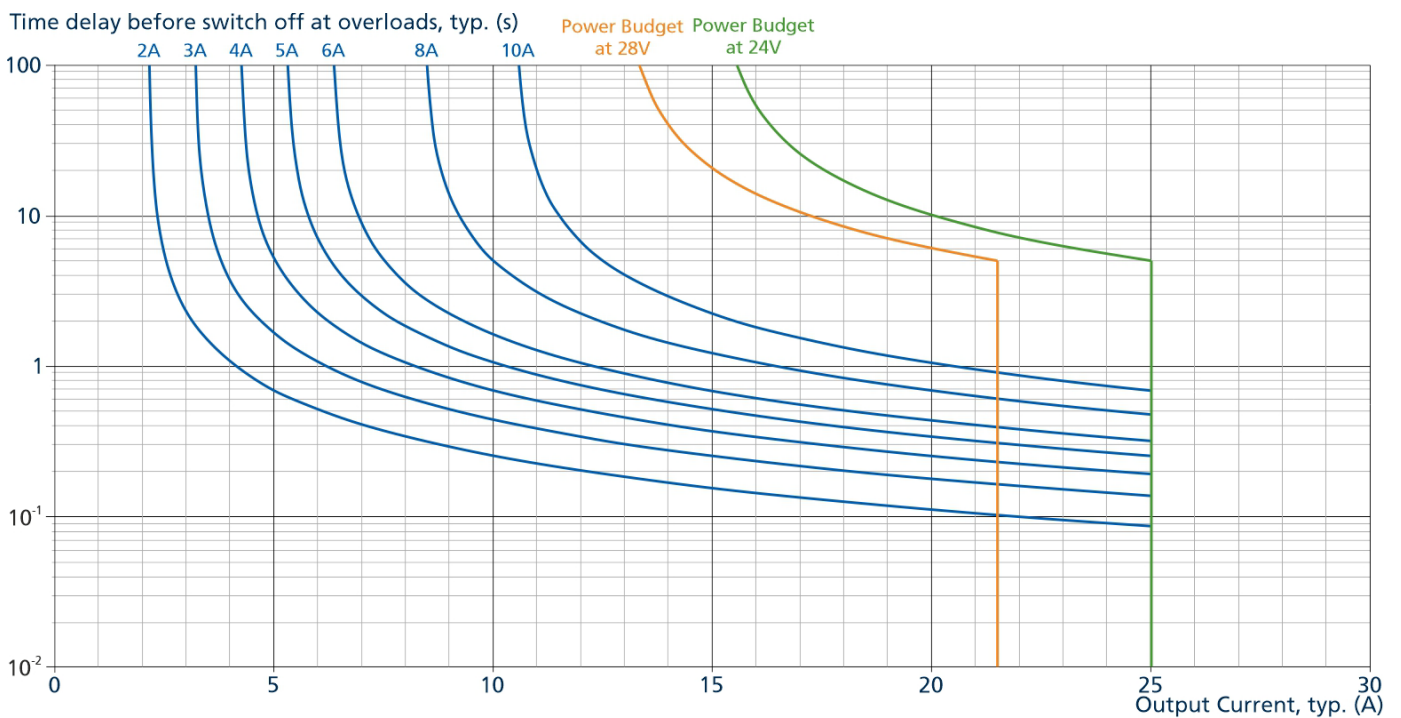

Fig. 6-3: Trip curve diagram

7. Hold-up Time

The hold-up time is the time during which a power supply's output voltage remains within specification following the loss of input power. The hold-up time is output load dependent. At no load, the hold-up time can be up to several seconds. The status LED is also on during this time.

		AC 100V	AC 120V	AC 230V	
Hold-up Time	typ.	75ms	75ms	75ms	At 150W output load, see Fig. 7-1
	min.	56ms	56ms	56ms	At 150W output load, see Fig. 7-1
	typ.	44ms	44ms	44ms	At 300W output load, see Fig. 7-1
	min.	29ms	29ms	29ms	At 300W output load, see Fig. 7-1

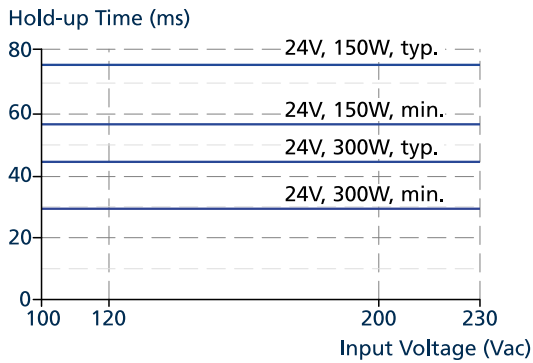

Fig. 7-1: Hold-up time vs. input voltage

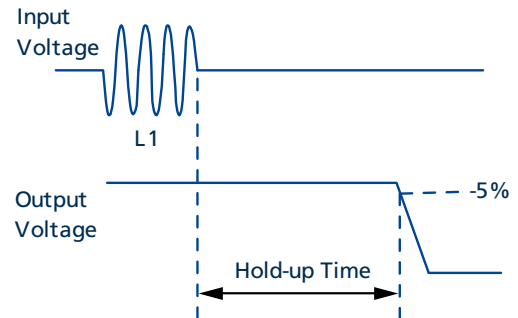

Fig. 7-2: Shut-down behavior, definitions

8. Efficiency and Power Losses

		AC 100V	AC 120V	AC 230V	
Efficiency	typ.	93.6%	94.3%	95.7%	At 24V, 300W
Average efficiency ¹⁾	typ.	92.9%	93.5%	94.6%	25% at 80W, 25% at 150W, 25% at 220W 25% at 300W
Power losses	typ.	2.7W	2.8W	2.2W	At 24V, 0W (no load)
	typ.	10.7W	10.0W	8.3W	At 24V, 150W (half load)
	typ.	20.5W	18.1W	13.5W	At 24V, 300W (full load)

¹⁾ The average efficiency is an assumption for a typical application where the power supply is loaded with 25% of the nominal load for 25% of the time, 50% of the nominal load for another 25% of the time, 75% of the nominal load for another 25% of the time and with 100% of the nominal load for the rest of the time.

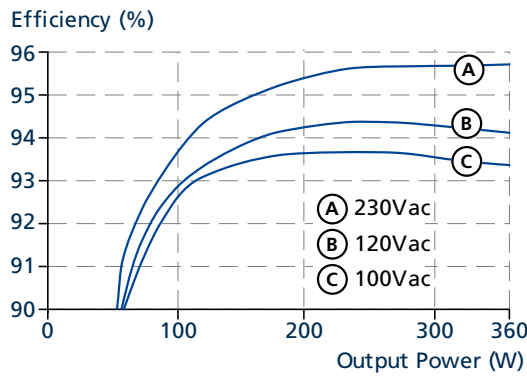

Fig. 9-1: Efficiency vs. output power at 24V, typ.

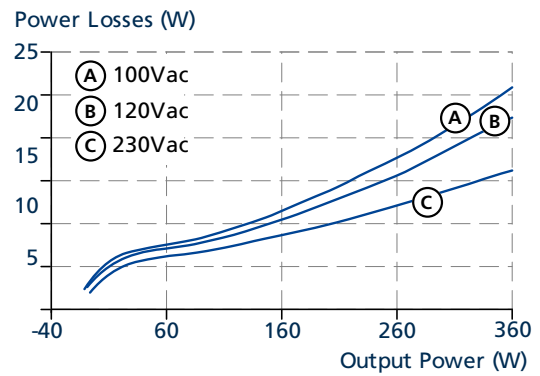

Fig. 9-2: Losses vs. output power at 24V, typ.

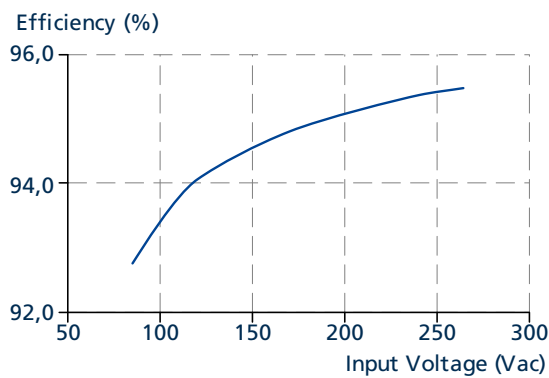

Fig. 9-3: Efficiency vs. input voltage at 24V, 300W, typ.

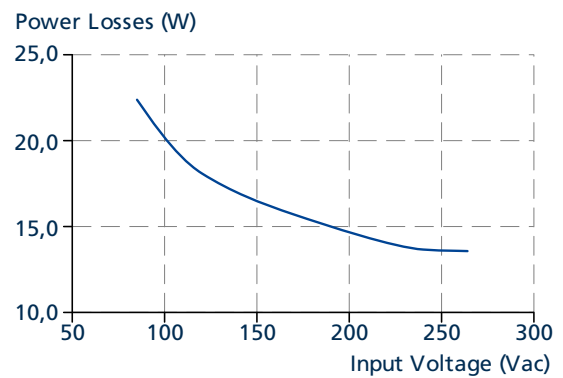

Fig. 9-4: Losses vs. input voltage at 24V, 300W, typ.

9. Lifetime Expectancy

The Lifetime expectancy shown in the table indicates the minimum operating hours (service life) and is determined by the lifetime expectancy of the built-in electrolytic capacitors. Lifetime expectancy is specified in operational hours and is calculated according to the capacitor's manufacturer specification.

The manufacturer of the electrolytic capacitors only guarantees a maximum life of up to 15 years (131 400h). Any number exceeding this value is a calculated theoretical lifetime which can be used to compare devices.

	AC 100V	AC 120V	AC 230V	
Calculated lifetime expectancy	88 600h	121 100h	175 200h	At 24V, 300W and 40°C
	257 900h	319 790h	410 500h	At 24V, 150W and 40°C
	247 300h	352 300h	432 500h	At 24V, 300W and 25°C
	530 100h	610 800h	834 400h	At 24V, 150W and 25°C

10. MTBF

MTBF stands for **Mean Time Between Failure**, which is calculated according to statistical device failures, and indicates reliability of a device. It is the statistical representation of the likelihood of a unit to fail and does not necessarily represent the life of a product.

A MTBF figure of e.g. 1 000 000 h means that statistically one unit will fail every 100 hours if 10 000 units are installed in the field. However, it can not be determined if the failed unit has been running for 50 000 h or only for 100 h.

For these types of units the MTTF (**Mean Time To Failure**) value is the same value as the MTBF value.

	AC 100V	AC 120V	AC 230V	
MTBF SN 29500, IEC61709	270 000h	305 000h	384 000h	At 24V, 300W and 40°C
	489 000h	546 000h	679 000h	At 24V, 300W and 25°C
MTBF MIL HDBK 217F	106 000h	118 000h	135 000h	At 24V, 300W and 40°C; Ground Benign GB40
	160 000h	175 000h	195 000h	At 24V, 300W and 25°C; Ground Benign GB25
	29 000h	32 000h	35 000h	At 24V, 300W and 40°C; Ground Fixed GF40
	39 000h	42 000h	46 000h	At 24V, 300W and 25°C; Ground Fixed GF25

11. Functional Diagram

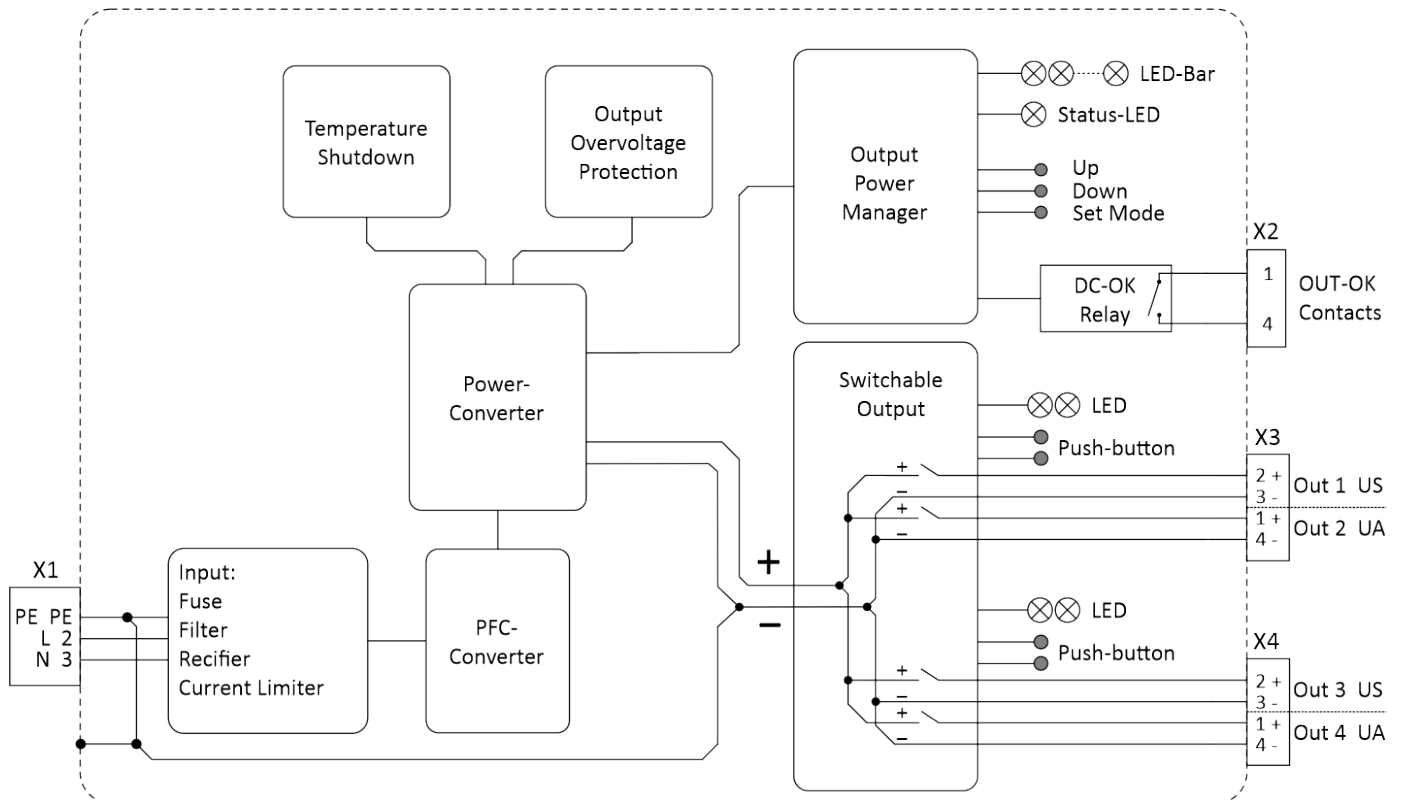
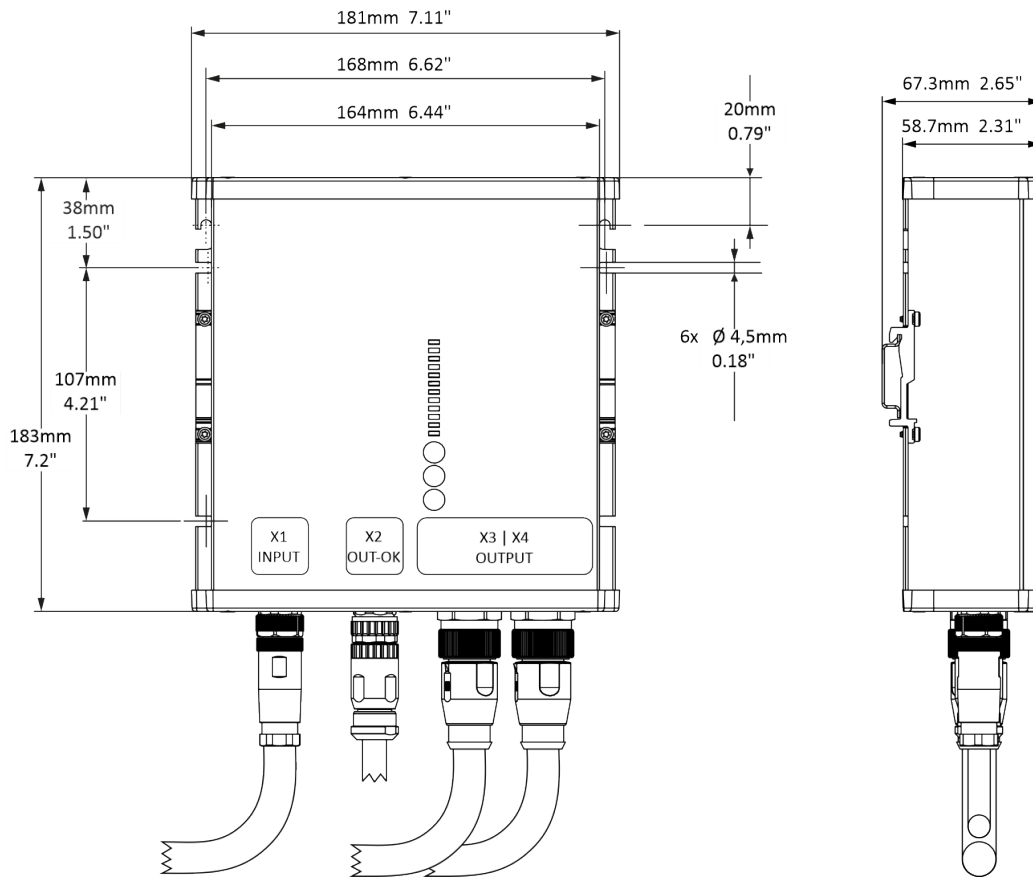

Fig. 12-1: Functional Diagram

12. Dimensions and Connector Variants



Width 181 mm / 7.11"
 Height 183 mm / 7.2"
 Depth 59 mm / 2.32"
 Weight 1200 g / 2.7lb

Housing body material Aluminium alloy
 Housing cover material Hi-grade polycarbonate
 Installation clearances See chapter 2
 Mating connectors See chapter 21.3

Input connector on power supply (X1):

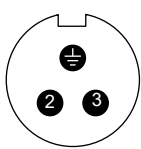

7/8" 3pin Male

Pin Ⓟ: PE connection
 Pin 2: L
 Pin 3: N

Out-OK connector on power supply (X2):

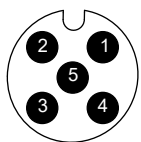

M12-A Male

Pin 1: Relay Connection
 Pin 2: not connected
 Pin 3: not connected
 Pin 4: Relay Connection
 Pin 5: not connected

Output connector on power supply (X3 and X4):

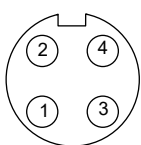

7/8" 4 pin Female

Pin 1:	24Vdc (Out 2 and 4) Ua	Actuator output
Pin 2:	24Vdc (Out 1 and 3) Us	Sensor output
Pin 3:	GND (Out 1 and 3) Us	Sensor output
Pin 4:	GND (Out 2 and 4) Ua	Actuator output

13. User Interface

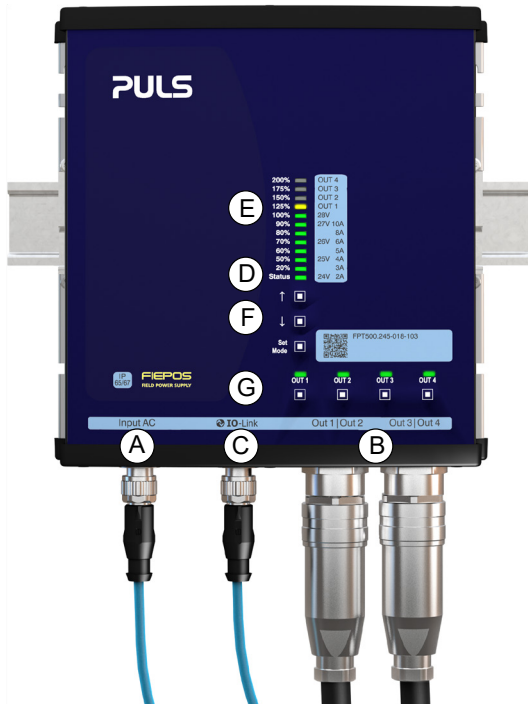

- A Input Connector
- B Output Connectors
- C Out-OK Connector
- D Status LED
- E LED Bar
- F Set Mode and Up and Down Button
- G Output LEDs ON/OFF & Reset Buttons

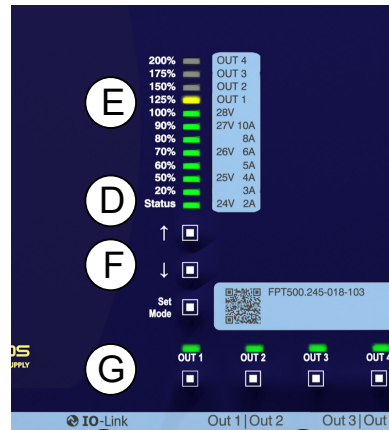

Overview

LED Bar (E)

The LED Bar is a multifunctional displaying tool. The main function is to monitor the sum of all outputs (percentages scale). It also can display the output voltage (voltage scale) and output current (percentage scale) for the individual outputs. The integrated Status LED displays different running conditions of the PSU in real-time.

Output Level Controls (F)

The Output Level Controls consist of the Set Mode button and the UP/DOWN buttons. The Set Mode is used to change into configuration mode. The UP/DOWN are used to adjust different output levels or change into the Output Current Monitor Mode.

Output Controls (G)

The Output Controls consist of an output LED and an Output ON/OFF button for each output. The Output LED displays different running conditions for output in real-time. The ON/OFF is used to switch the output on/off or reset the output.

Operation Settings

Monitor Output Power Mode

The Output Power Mode displays the actual total output power after startup. It is the default mode of the LED Bar. The output power is displayed in percentages of 300W. E.g. If the LED Bar shows 50%, then the supply is delivering 150W. If the LED Bar goes above 100% and exceeds 300W, the 125% LED flashes orange. The percentage scale is shown on the left of the LEDs.

Monitor Output Current Mode

The Output Current Mode is to check the output current of the individual outputs.

To inspect these output currents:

- Press the UP button. OUT1 on the LED bar lights up in orange and the output current is displayed in real-time on the LED Bar below. The ampere scale is shown to the right of the LEDs.
- On the LED Bar switch between OUT1 - OUT4 using the UP/DOWN buttons to check the different output current values.
- Return to the Output Power Mode (default mode) by selecting above (OUT4) or below (OUT1).

All parameters are specified at 24V, 12.5A, 230Vac, 25°C ambient and after a 5 minutes run-in time unless otherwise noted.

Set Trip Current

To set a new trip current:

- Press Set Mode for 3s. After all LEDs light up, the LED now displays the set voltage.
- Press Set Mode to select the desired output to change the trip current. The orange LED will indicate which output is selected.
- Push the UP/DOWN arrows to increase or decrease the set point. The current values are shown to the right of the LEDs. (e.g. 20 %-LED indicates 3A).
- New point is set.
- After 15s of no button activity, the PSU will automatically switch to Output Power Mode.

Set Output Voltage

To set a new output voltage:

- Press Set Mode for 3s. After all LEDs light up, the LED now displays the set voltage.
- Push the UP/DOWN arrows to increase or decrease the set point. The voltage values are shown to the right of the LEDs. (e.g. 20%-LED indicates 24.5V).
- New point is set.
- After 15s of no button activity, the PSU will automatically switch to Output Power Mode.

Lock the Control Panel

To activate/deactivate the button lock:

- Press the UP and DOWN arrow buttons simultaneously for 3s. The LED bar will flash for 5s to indicate the changed button lock status.

Reset Output

In a failure mode where the output switched OFF:

- Push and hold ON/OFF button for more than 1s.

LED Signaling

Status LED (D)

The Status LED displays different running conditions of the PSU in real-time.



Green: On

DC voltage is above 90 % of set point voltage. All outputs are operating according to their settings.

OFF

DC voltage is below 90 % of set point voltage or an output channel has tripped or PSU is not powered.

Red: AC input failure

AC input drops below the specified levels and outputs turned off.

Flashes red: Over-temperature

The PSU turns OFF to prevent overheating. Normal operating conditions continues when the temperature falls to a safe level and is indicated by the Status LED turning solid green.

Channel LED Signaling Overview

Below is an overview of the output LED signaling.



Fig. 14-1: Location of outputs LEDs

- OFF**
 Output is switched OFF by ON/OFF button on the control panel or PSU is not powered (Check. Status LED).
- Green: Output On**
- Flashes green: Power budget tripped** (slow rate: 250ms ON/OFF)
 Low priority outputs are tripped. Sum of output currents are above PSU power budget.
- Flashes green: Buttons Locked** (fast rate: 125ms ON/OFF)
 No action is carried out as lock function is activated. Unlock buttons by following procedure described above. Other possible reason: MOSFET is >90 °C or Interval between Turn On cycles <5s.
- Orange: Pre-Alarm**
 Output is still on but current is above set pre-alarm level. Overload condition possible.
- Flashes orange: Overload** (slow rate: 500ms ON/OFF)
 Output is tripped. The output current exceeded the set trip value. After the fault has been cleared, the output can be switched on via the control panel.
- Flashes orange: Faulty Installation** (medium rate: 250ms ON/OFF)
 Output is Tripped. Cable or connected hardware on the outputs are not installed correctly. Switch off the output manually by pushing the specific output ON/OFF button.
- Flashes orange: Short Circuit** (fast rate: 125ms ON/OFF)
 Output is tripped. The output current exceeded approximately 48A. Short circuit conditions may be an electrical short, loads beyond specification, energizing large capacitors, etc. After the fault has been cleared, the output can be switched on via the control panel.
- Flashes Orange/Green: Over-temperature** (slow rate, 500ms orange/green)
 Output will automatically turned OFF when MOSFET over-temperature of 125°C is reached. When the MOSFET temperature falls below 90 °C the output will turn on automatically.
- Red: MOSFET Malfunction**
 PSU turns OFF. Output stage on specific output is damaged. Replacement of PSU might be required.
 Possible malfunction:
 - Positive current output in OFF state exceeds >2 A for more than >0.5 s
- Flashes red: Hardware Specs Out of Range** (slow rate, 500ms ON/OFF)
 Affected output channel turns OFF. Internal circuitry Hardware is out of specified range. Replacement of PSU might be required.

14. EMC

The EMC behavior of the device is designed for applications in industrial environment as well as in residential, commercial and light industry environments.

The device is investigated according to EN 61000-6-1, EN 61000-6-2, EN 61000-6-3, EN 61000-6-4, EN 61000-3-2 and EN 61000-3-3.

EMC immunity

Electrostatic discharge	EN 61000-4-2	Contact discharge	8kV	Criterion A
Air discharge		Air discharge	15kV	Criterion A
Electromagnetic RF field	EN 61000-4-3	80MHz - 2.7GHz	20V/m	Criterion A
		2.7GHz - 6GHz	10V/m	Criterion A
Magnetic field	EN 61000-4-8	50Hz/60Hz	30A/m	Criterion A
Fast transients (Burst)	EN 61000-4-4	AC Input lines	4kV	Criterion A
		DC Output lines	4kV	Criterion A
		Out-OK	4kV	Criterion A
Surge voltage on AC input	EN 61000-4-5	L to N	2kV	Criterion A
		L to PE, N to PE	4kV	Criterion A
Surge voltage on DC output	EN 61000-4-5	+ to -	1kV	Criterion A
		+/- to PE	2kV	Criterion A
Surge voltage on Out-OK	EN 61000-4-5	Out-OK to PE	1kV	Criterion A
Conducted immunity	EN 61000-4-6	0.15 - 80MHz	20V	Criterion A
Voltage dips	EN 61000-4-11	0% of 100Vac	0Vac, 20ms	Criterion A
		40% of 100Vac	40Vac, 200ms	Criterion C
		70% of 100Vac	70Vac, 500ms	Criterion C
		0% of 200Vac	0Vac, 20ms	Criterion A
		40% of 200Vac	80Vac, 200ms	Criterion A
		70% of 200Vac	140Vac, 500ms	Criterion A
Voltage interruptions	EN 61000-4-11	0 V	5000 ms	Criterion C
Voltage sags	SEMI F47	Dips on the input voltage according to SEMI F47 standard		
		80% of 120Vac (96Vac)	1000ms	Criterion A
		70% of 120Vac (84Vac)	500ms	Criterion A
		50% of 120Vac (60Vac)	200ms	Criterion A
Powerful transients	VDE 0160	Over entire load range	750V, 0.3ms	Criterion A

Performance criterions:

A: The device shows normal operation behavior within the defined limits.

C: Temporary loss of function is possible. The device may shut-down and restarts by itself. No damage or hazards for the device will occur.

EMC Emission

Conducted emission AC input lines	EN 55011, EN 55015, EN 55032, FCC Part 15, CISPR 11, CISPR 32	Class B
Conducted emission DC output lines	IEC/CISPR 16-1-2, IEC/CISPR 16-2-1	
Conducted emission IO-Link output		
Radiated emission	EN 55032 / EN 55011	Class B
Harmonics	EN 61000-3-2	Class A fulfilled between 0A and 12A load
Voltage fluctuations, flicker	EN 61000-3-3	Pass tested with constant current loads, non pulsing

This device complies with FCC Part 15 rules.

Operation is subjected to following two conditions: (1) this device may not cause harmful interference, and (2) this device must accept any interference received, including interference that may cause undesired operation.

Switching Frequencies

PFC converter	20 kHz to 135 kHz	Input voltage and output load dependent
Main converter	60 kHz to 140 kHz	Output load dependent
Auxiliary converter	54 kHz to 66 kHz	Output load dependent
Microcontroller clocks	48 Mhz and 32 MHz	Fixed frequency

15. Environment

Operational temperature	-25 °C to +70 °C (-13 °F to 158 °F)	Operational temperature is the same as the ambient or surrounding temperature and is defined as the air temperature 2cm below the unit.
Storage temperature	-40 °C to +85 °C (-40 °F to 185 °F)	For storage and transportation
Output derating	6 W/°C 10 W/°C 20 W/1000 m or 5°C/1000 m	Between +45 °C and +55 °C (113 °F to 131 °F) Between +55 °C and +70 °C (131 °F to 140 °F) For altitudes >2000 m (6560 ft), see Fig. 16 2: Output power vs. altitude
	The derating is not hardware controlled. The user has to take care to stay below the derated current limits in order not to overload the unit.	
Humidity	5 to 95 % r.h.	According to IEC 60068-2-30
Atmospheric pressure	54-110k Pa	see Fig. 16-2: Output power vs. for details
Altitude	Up to 5000 m (16 400 ft)	see Fig. 16-2: Output power vs. for details
Over-voltage category	III	According to IEC 60664-1 For TN, TT mains systems with earthed neutral and IT star mains systems with insulation monitoring for altitudes up to 2000 m
	II	According to IEC 60664-1 For TN, TT mains systems with earthed neutral and IT star mains systems with insulation monitoring for altitudes between 2000 m and 5000 m
		According to IEC 60664-1 For TN, TT, IT Delta mains systems or IT star mains systems without insulation monitoring for altitudes up to 2000 m
Degree of pollution	3	According to IEC 62477-1, not conductive
Vibration sinusoidal	2-17.8 Hz: ±1.6 mm; 17.8-500 Hz: 2 g 2 hours / axis	According to IEC 60068-2-6
Shock	30 g 6 ms, 20 g 11 ms 3 bumps / direction, 18 bumps in total	According to IEC 60068-2-27
	Shock and vibration is tested in combination with DIN-Rails according to EN 60715 with a height of 15 mm and a thickness of 1.3 mm and standard orientation.	
LABS compatibility	Yes	
Audible noise	Some audible noise may be emitted from the power supply during no load, overload or short circuit.	

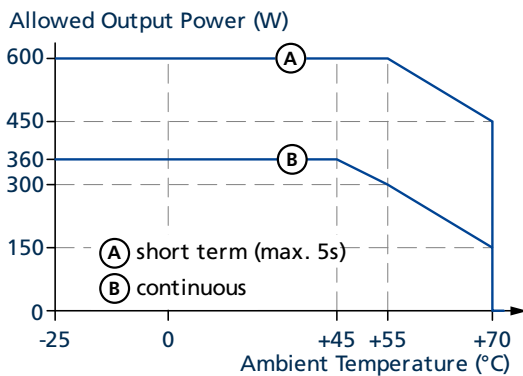

Fig. 16-1: Output power vs. ambient temp.

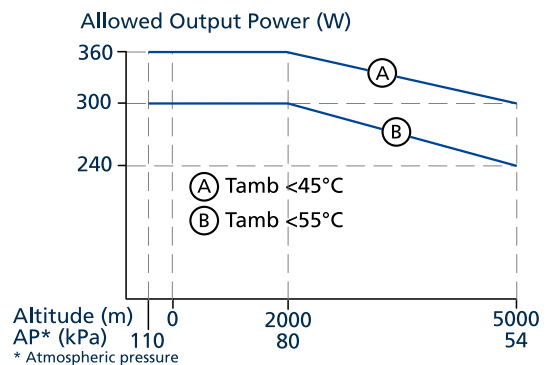

Fig. 16-2: Output power vs. altitude

All parameters are specified at 24V, 12.5A, 230Vac, 25°C ambient and after a 5 minutes run-in time unless otherwise noted.

16. Safety and Protection Features

Isolation resistance	min.	500 MOhm	At delivered condition between input and output, measured with 500 Vdc
	min.	500 MOhm	At delivered condition between input and PE, measured with 500 Vdc
PE resistance	max.	0.1 Ohm	Resistance between PE terminal and the housing IEC/EN/UL 61010-2-201, IEC/EN 62368-1, IEC/EN 60950-1
Input/Output separation		PELV	
Output over-voltage protection	typ.	31.8 Vdc	In case of an internal defect, a redundant circuit limits the maximum output voltage. The output shuts down and automatically attempts to restart
	max.	32.5 Vdc	
Class of protection			According to IEC 61140 A PE (Protective Earth) connection is required
Ingress protection		IP 65/67	According to EN/IEC 60529
Over-temperature protection		Included	Output shut down with automatic restart. Temperature sensors are installed on critical components inside the unit and turns the unit off in safety critical situations, which can happen e.g. when ambient temperature is too high, ventilation is obstructed or the de-rating requirements are not followed. There is no correlation between the operating temperature and turn-off temperature since this is dependent on input voltage, load and installation methods.
Input transient protection		MOV (Metal Oxide Varistor)	For protection values, see chapter 17, EMC.
Internal input fuse		Included	Not user replaceable slow-blow high-breaking capacity fuse
Touch current	max.	0.51 mA _{rms}	At 264Vac, 60Hz

17. Dielectric Strength

The negative terminal of the outputs is permanently connected to PE within the unit. The output is insulated from the input by a double or reinforced insulation.

Type and routine tests are conducted by the manufacturer. Field tests may be conducted in the field using the appropriate test equipment which applies the voltage with a slow ramp (2s up and 2s down). Connect all input-terminals before conducting the test. When testing, set the cut-off current settings to the value in the table below.

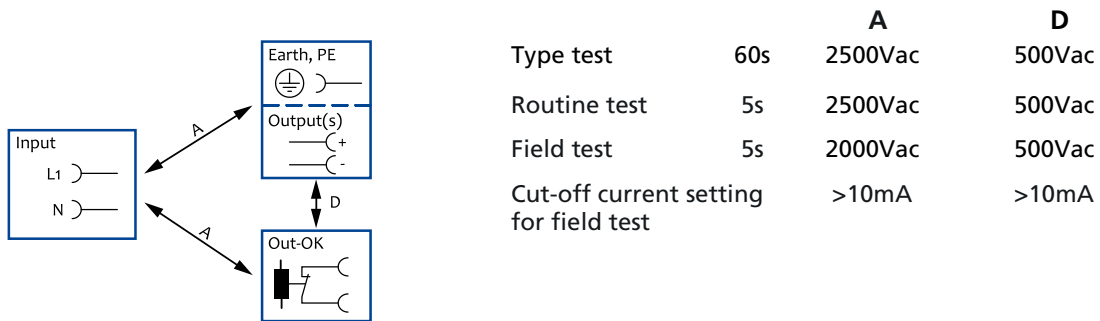



Fig. 18-1: Dielectric strength

18. Approvals and Fulfilled Standards

IEC 62368	CB Report	CB Scheme Certificate IEC 62368-1 - Audio/video, information and communication technology equipment - Safety requirements Output safety level: ES1
IEC 61010	CB Report	CB Scheme Certificate IEC 61010-2-201 - Safety requirements for electrical equipment for measurement, control, and laboratory use - Part 1: General requirements
IEC 60950	Safety ✓	Manufacturers Declaration IEC 60950-1 - General safety requirements for Information Technology Equipment (ITE)
UL 61010		UL Certificate Listed equipment for category NMTR - UL 61010-2-201 - Safety requirements for electrical equipment for measurement, control, and laboratory use - Part 1: General requirements Applicable for US and Canada E-File: E198865
Semi F47	SEMI F47	Test Report Voltage Sag Immunity for Semiconductor Processing Equipment Tested for AC 208V L-L or L-N mains voltages, nominal output voltage and nominal output load
VDMA 24364	LABS VDMA 24364-C1-L/W	Paint Wetting Impairment Substances Test (or LABS-Test) Tested for Zone 2 and test class C1 according to VDMA 24364-C1-L/W for solvents and water-based paints

19. Regulatory Compliance

EU Declaration of Conformity		Trade conformity assessment for Europe The CE mark indicates conformance with the European <ul style="list-style-type: none"> - EMC directive - Low-voltage directive (LVD) - RoHS directive
WEEE Directive		Manufacturer's Statement EU-Directive on Waste Electrical and Electronic Equipment (WEEE) registered in Germany as business to business (B2B) products. WEEE-Reg.-Nr. DE 55837529
REACH Regulation (EU)		Manufacturer's Statement EU regulation regarding the Registration, Evaluation, Authorization and Restriction of Chemicals (REACH) fulfilled.
China RoHS		Manufacturer's Statement The device meets the Measures for Restriction of the Use of Hazardous Substances in Electrical & Electronic Products according the China-RoHS requirements. The device is marked with EFUP symbol 25 years (Environmentally Friendly Use Period)
IEC/EN 61558-2-16 (Annex BB)	Safety Isolating Transformer	Safety Isolating Transformers corresponding to Part 2-6 of the IEC/EN 61558

20. Accessories

20.1. DIN RAIL Mounting KIT: ZM.FPDRA-11

(ZM.FPDRA-10 US only)

In addition to screw mounting FIEPOS can easily be attached to a DIN rail using the DIN rail mounting kit.

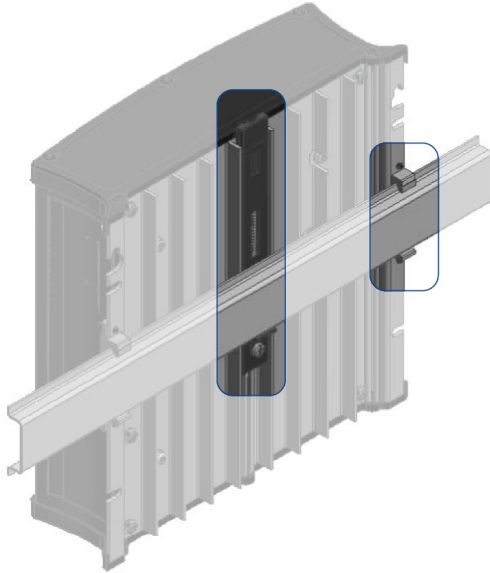

- DIN-Rail not included

20.2. Mounting Bracket: ZM.FPMBA-11

(ZM.FPMBA-10 US only)

In addition to screw mounting FIEPOS can easily be attached to a mounting bracket.

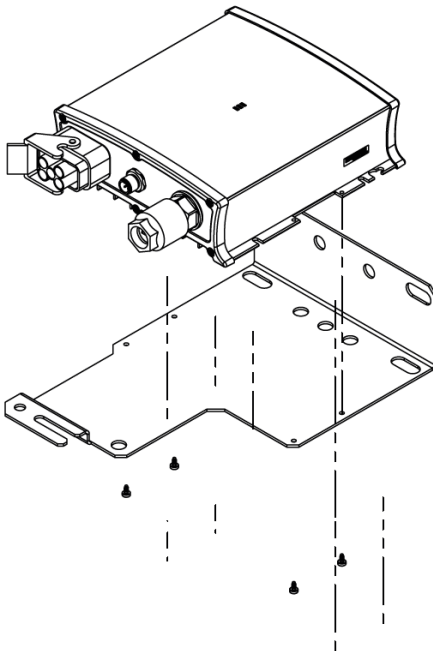

20.3. Mating Connectors

FIEPOS features a large number of different connectors. In some cases mating connectors and/or cord assemblies can be ordered from PULS. Ask your PULS representative if available.

All parameters are specified at 24V, 12.5A, 230Vac, 25°C ambient and after a 5 minutes run-in time unless otherwise noted.

21. Application Notes

21.1. Repetitive Pulse Loading

Typically, a load current is not constant and varies over time. This power supply is designed to support loads with a higher short-term power demand (BonusPower). The short-term duration is hardware controlled by an output power manager and is available on a repeated basis. If the average load is higher than the sum of all output power, the output voltage will dip.

To avoid this, the following rules must be followed:

- a) The power demand of the pulse must be below 200 of the nominal output power.
- b) The duration of the pulse power must be shorter than the allowed BonusPower time, see chapter 6
- c) The average power should be lower than the nominal output power.

The R.M.S. output current must be below the specified continuous output current. If the R.M.S. current is higher, the unit may respond with a thermal shut-down after a period of time.

21.2. External Input Protection

The device is designed, tested and approved for branch circuits up to 20 A (UL) and 32 A (IEC) without additional protection device. If an external fuse is utilized, do not use circuit breakers smaller than 6 A B- or C-Characteristic to avoid a nuisance trip.

21.3. Inductive and Capacitive Loads

The unit is designed to supply any kind of loads, including capacitive and inductive loads. If extreme large capacitors, such as EDLCs (electric double layer capacitors or "UltraCaps") with a capacitance larger than 20mF are connected to the output, the unit might charge the capacitor or the output might trip, chapter 6.

21.4. Back Feeding Loads

Loads such as decelerating motors and inductors can feed voltage back to the power supply. This feature is also called return voltage immunity or resistance against Back- **E.M.F.** (**E**lectro **M**agnetic **F**orce).

This power supply is resistant and does not show malfunctioning when a load feeds back voltage to the power supply below 35V (4J). It does not matter whether the power supply is on or off.

21.5. Mounting Orientations

The device can be mounted in various mounting orientations. The listed lifetime and MTBF values from this datasheet apply only for the standard mounting orientation. The following curves give an indication for allowed output power in different mounting orientations for altitudes up to 2000 m (6560 ft).

A

Standard Orientation

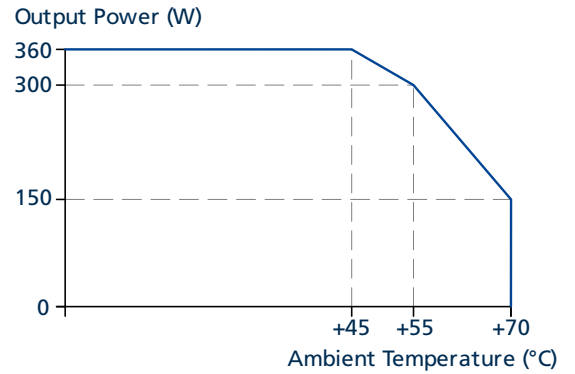
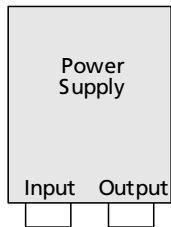

B

Upside down

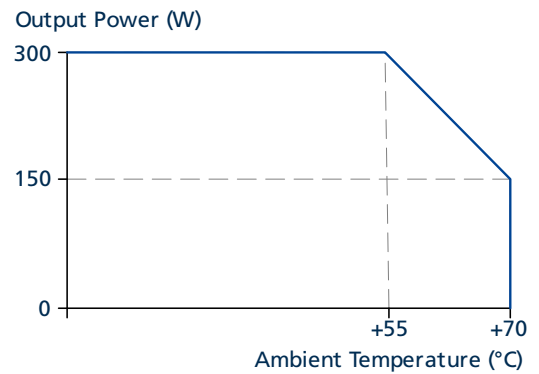
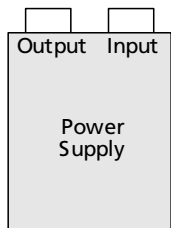

C

Horizontal cw and ccw

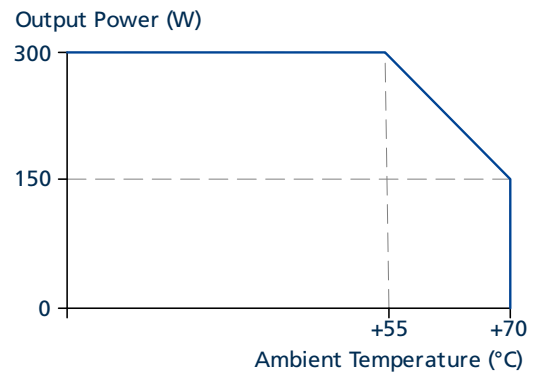

D

Over-head and Table-top mounting

