

EN ZM13.SIDE Installation Manual
 DE ZM13.SIDE Installationsanleitung
 FR ZM13.SIDE Manuel d'installation
 ES ZM13.SIDE Manual de instalación

Side Mount Bracket
 Seitlicher Montagewinkel
 Kit de montage latéral
 Soporte de montaje lateral

Doc. ID: PU-200.015.82-xxA (2019-01-10-MR1)

Product Description

The ZM13.SIDE is a mechanical accessory to mount the device sideways with or without utilizing a DIN-rail to save installation depth.

The two aluminum brackets and the black plastic slider of the unit have to be detached, so that the ZM13.SIDE steel bracket can be mounted.

For sideways DIN-rail mounting, the removed aluminum brackets and the black plastic slider need to be mounted on the ZM13.SIDE steel bracket.

The order number ZM13.SIDE contains one bracket and four screws, which are needed for sideways DIN-rail mounting.

Intended Use

This mechanical accessory is designed for DIN-rail devices. Check the product datasheet of the DIN-rail device to confirm that it is suitable for the desired device.

Technical Data

Size (width x height x depth) 65x145x63mm

Weight 180g / 0.4lb

Mechanical Dimensions

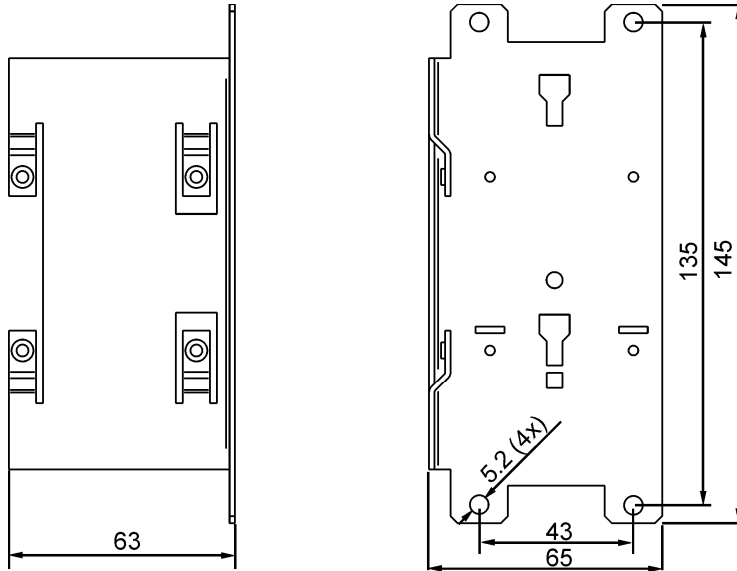

All dimension in mm

Headquarters: PULS GmbH, Elektrastr. 6, 81925 Munich, Germany, www.pulspower.com

Germany +49 89 9278 0

France +33 478 668 941

Austria +43 2764 3213

Switzerland +41 56 450 18 10

China +86 512 62881820

North America +1 630 587 9780

Singapore +65 6684 2310

United Kingdom +44 1525 841001

The information in this document is believed to be accurate and reliable and may change without notice.

Mounting Example – Wall Mounting

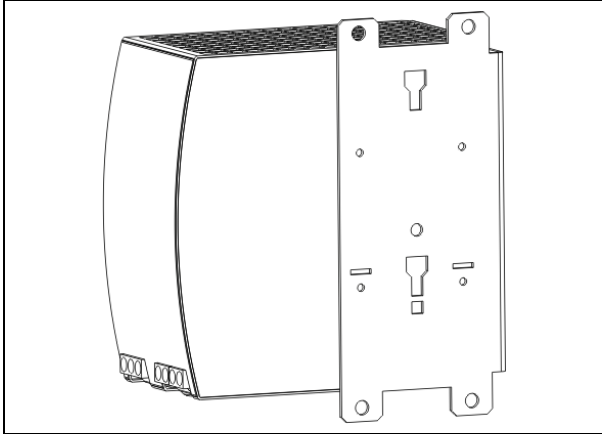

Mounting Example – DIN-Rail Mounting

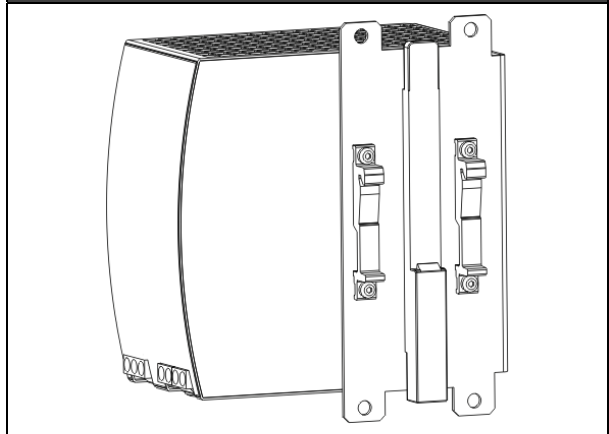

Installation Instructions

- 1) Detach the two aluminium brackets by removing the four screws with a Torx screwdriver (Torx 10). Save the screws for step 3.
- 2) Remove the plastic lock mechanism by using a flat-blade screwdriver to move the lock downwards while at the same time push the plastic slide upwards. Detach the plastic slide.
- 3) Mount the steel brackets with the same screws from the DIN-Rail brackets using caution not to over-tighten the screws! Recommended tightening torque is 0.6Nm. (5.3lb.in).

Preparation for DIN-Rail mounting

Install the two aluminium brackets and the plastic slide (detached from the unit before) onto the side mounting plant with the additional screws provided.

Installation Instructions

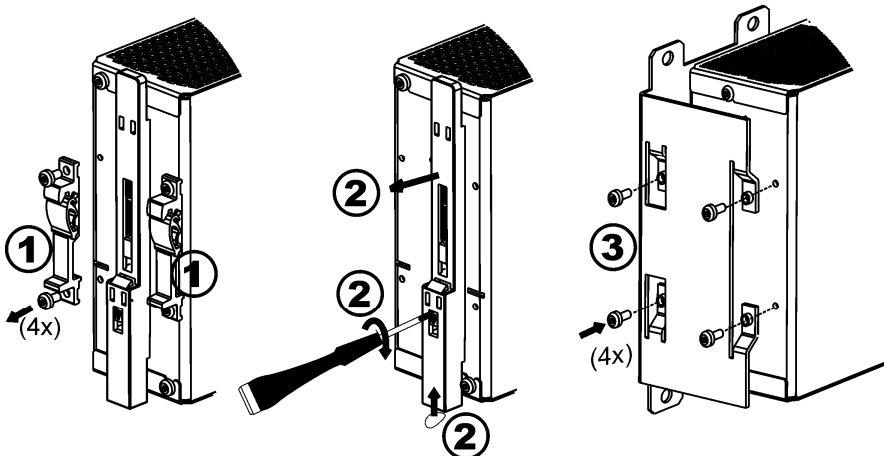

Drawing shows a similar unit