



### POWER SUPPLY

- AC 100-240V Wide-range Input
- Width only 125mm, Weight only 1.9kg
- 94.6% Full Load and Excellent Partial Load Efficiencies
- Version-C2 with Partially Conformally Coated PCB
- 50% BonusPower, 1440W for up to 4s
- 110A High Peak Current for 10ms for Easy Fuse Tripping
- Safe Hiccup<sup>PLUS</sup> Overload Mode
- Active PFC (Power Factor Correction)
- Negligible Low Input Inrush Current Surge
- Full Power Between -25°C and +60°C
- Current Sharing Feature for Parallel Use
- Internal Data Logging for Troubleshooting Included.
- Remote Control of Output Voltage
- DC-OK Relay Contact
- Shut-down Input
- ATEX and IECEx Approved
- 3 Year Warranty

### PRODUCT DESCRIPTION

The most outstanding features of this Dimension QS40.241 DIN rail power supply are the extremely high efficiency and the small size, which are achieved by a synchronous rectification, a bridgeless PFC circuit and additional unique design details.

Large power reserves of 150% and built-in large sized output capacitors support the starting of heavy loads such as DC motors or capacitive loads. In many cases this allows the use of a unit from a lower wattage class which saves space and money.

High immunity to transients and power surges as well as low electromagnetic emissions makes usage in nearly every environment possible.

The integrated input fuse as well as the near zero input inrush current make installation and usage simple. Diagnostics are easy due to the DC-OK relay, a green DC-OK LED and the red overload LED.

A large international approval package for a variety of applications makes this unit suitable for nearly every application.

### SHORT-FORM DATA

Output voltage	DC 24V	nominal
Adjustment range	24 - 28Vdc	
Output current	40 - 34.3A	continuous
	60 - 51.5A	short term (4s)
Output power	960W	continuous
	1440W	short term (4s)
Output ripple	< 100mVpp	20Hz to 20MHz
Input voltage	AC 100-240V	-15%/+10%
Mains frequency	50-60Hz	±6%
AC Input current	8.6 / 4.5A	at 120 / 230Vac
Power factor	0.99 / 0.99	at 120 / 230Vac
AC Inrush current	17 / 11A peak	at 120 / 230Vac
Efficiency	93.6 / 94.6%	at 120 / 230Vac
Losses	65.6 / 54.8W	at 120 / 230Vac
Temperature range	-25°C to +70°C	operational
Derating	24W/°C	+60 to +70°C
		between 85-90Vac see chapter 18
Hold-up time	27 / 27ms	at 120 / 230Vac
Dimensions	125x124x127mm	WxHxD
Weight	1900g	

### ORDER NUMBERS

Power Supply	<b>QS40.241</b> <b>QS40.241-C2</b>	24-28V Standard unit Partially conformally coated PCB
Accessory	ZM2.WALL UF20.241 YR80.242 YR40.245	Wall mount bracket Buffer unit Redundancy module Redundancy module

### MAIN APPROVALS

For details and the complete approval list, see chapter 22.



UL 508



ATEX



UL 60950-1



IECEx



Class I Div 2



Marine

### INDEX

	Page		Page
1. Intended Use .....	3	23. Regulatory Product Compliance .....	21
2. Installation Instructions.....	3	24. Physical Dimensions and Weight .....	22
3. AC-Input .....	5	25. Accessories.....	23
4. Input Inrush Current.....	6	25.1. ZM2.WALL - Wall mounting bracket .....	23
5. DC-Input .....	6	25.2. UF20.241 - Buffer module .....	23
6. Output .....	7	25.3. YR80.242 - Redundancy Module .....	24
7. Hold-up Time.....	9	25.4. YR40.245 - Redundancy Module .....	24
8. DC-OK Relay Contact .....	10	26. Application Notes.....	25
9. Shut-down Input .....	10	26.1. Repetitive Pulse Loading .....	25
10. Remote Control of Output Voltage .....	11	26.2. Peak Current Capability.....	26
11. Internal Data Logging .....	11	26.3. External Input Protection .....	26
12. Efficiency and Power Losses.....	12	26.4. Charging of Batteries.....	27
13. Lifetime Expectancy and MTBF .....	13	26.5. Output Circuit Breakers.....	27
14. Functional Diagram .....	13	26.6. Parallel Use to Increase Output Power .....	28
15. Terminals and Wiring .....	14	26.7. Parallel Use for Redundancy .....	28
16. Front Side and User Elements .....	15	26.8. Series Operation.....	29
17. EMC.....	16	26.9. Inductive and Capacitive Loads .....	29
18. Environment.....	17	26.10. Back-feeding Loads .....	29
19. Protection Features.....	18	26.11. Operation on Two Phases .....	30
20. Safety Features.....	18	26.12. Use in a Tightly Sealed Enclosure .....	30
21. Dielectric Strength.....	19	26.13. Mounting Orientations.....	31
22. Approved, Fulfilled or Tested Standards .....	20		

The information presented in this document is believed to be accurate and reliable and may change without notice.  
 No part of this document may be reproduced or utilized in any form without permission in writing from the publisher.

### TERMINOLOGY AND ABBREVIATIONS

<b>PE and <math>\oplus</math> symbol</b>	PE is the abbreviation for <b>Protective Earth</b> and has the same meaning as the symbol $\oplus$ .
<b>Earth, Ground</b>	This document uses the term "earth" which is the same as the U.S. term "ground".
<b>t.b.d.</b>	To be defined, value or description will follow later.
<b>AC 230V</b>	A figure displayed with the AC or DC before the value represents a nominal voltage with standard tolerances (usually $\pm 15\%$ ) included. E.g.: DC 12V describes a 12V battery disregarding whether it is full (13.7V) or flat (10V)
<b>230Vac</b>	A figure with the unit (Vac) at the end is a momentary figure without any additional tolerances included.
<b>50Hz vs. 60Hz</b>	As long as not otherwise stated, AC 230V parameters are valid at 50Hz mains frequency.
<b>may</b>	A key word indicate flexibility of choice with no implied preference.
<b>shall</b>	A key word indicate a mandatory requirement.
<b>should</b>	A key word indicate flexibility of choice with a strongly preferred implementation.

## 1. INTENDED USE

This device is designed for installation in an enclosure and is intended for commercial use, such as in industrial control, process control, monitoring and measurement equipment or the like.

Do not use this device in equipment, where malfunctioning may cause severe personal injury or threaten human life without additional appropriate safety devices, that are suited for the end application.

If this device is used in a manner outside of its specification, the protection provided by the device may be impaired.

## 2. INSTALLATION INSTRUCTIONS

### **WARNING** Risk of electrical shock, fire, personal injury or death.

- Turn power off before working on the device and protect against inadvertent re-powering.
- Do not open, modify or repair the device.
- Use caution to prevent any foreign objects from entering into the housing.
- Do not use in wet locations or in areas where moisture or condensation can be expected.
- Do not touch during power-on, and immediately after power-off. Hot surface may cause burns.

Obey the following installation instructions:

This device may only be installed and put into operation by qualified personnel.

This device does not contain serviceable parts. The tripping of an internal fuse is caused by an internal defect.

If damage or malfunction should occur during installation or operation, immediately turn power off and send unit to the factory for inspection.

Install device in an enclosure providing protection against electrical, mechanical and fire hazards. Install the device onto a DIN rail according to EN 60715 with the input terminals on the bottom of the device. Other mounting orientations require a reduction in output current.

Make sure that the wiring is correct by following all local and national codes. Use appropriate copper cables that are designed for a minimum operating temperature of 60°C for ambient temperatures up to +45°C, 75°C for ambient temperatures up to +60°C and 90°C for ambient temperatures up to +70°C. Ensure that all strands of a stranded wire enter the terminal connection. Unused screw terminals should be securely tightened. Use ferrules for wires on the input terminals.

The device is designed for pollution degree 2 areas in controlled environments. No condensation or frost is allowed.

The enclosure of the device provides a degree of protection of IP20. The enclosure does not provide protection against spilled liquids.

The device is designed for overvoltage category II zones.

The device is designed as "Class of Protection I" equipment according to IEC 61140. Do not use without a proper PE (Protective Earth) connection.

The device is suitable to be supplied from TN, TT or IT mains networks. The continuous voltage between the input terminal and the PE potential must not exceed 276Vac.

A disconnecting means shall be provided for the input of the device.

The device is designed for convection cooling and does not require an external fan. Do not obstruct airflow and do not cover ventilation grid!

The device is designed for altitudes up to 4000m. Above 2000m a reduction in output current is required.

Keep the following minimum installation clearances: 40mm on top, 20mm on the bottom, 5mm left and right side. Increase the 5mm to 15mm in case the adjacent device is a heat source. When the device is permanently loaded with less than 50%, the 5mm can be reduced to zero.

The device is designed, tested and approved for branch circuits up to 30A (UL) and 32A (IEC) without additional protection device. If an external fuse is utilized, do not use circuit breakers smaller than 16A B- or C-Characteristic to avoid a nuisance tripping of the circuit breaker.

The maximum surrounding air temperature is +70°C. The operational temperature is the same as the ambient or surrounding air temperature and is defined 2cm below the device.

The device is designed to operate in areas between 5% and 95% relative humidity.

### **Installation Instructions for Hazardous Location Areas**

The device is suitable for use in Class I Division 2 Groups A, B, C, D locations and for use in Group II Category 3 (Zone 2) environments.

Classification: ATEX: EPS 14 ATEX 1 638 X, II 3G Ex ec nC IIC T4 Gc / IECEx EPS 14.0007X

### **WARNING EXPLOSION HAZARDS!**

Substitution of components may impair suitability for this environment.

Do not disconnect the device, operate the voltage adjustment or the S/P jumper unless power has been switched off or the area is known to be non-hazardous.

A suitable enclosure must be provided for the end product which has a minimum protection of IP54 and fulfils the requirements of the EN 60079-0

### 3. AC-INPUT

AC input	nom.	AC 100-240V	suitable for TN, TT and IT mains networks
AC input range		90-264Vac	< 55°C ambient temperature continuously allowed > 55°C ambient temperature short term or with output derating according Fig. 18-1 full power for up to 200ms no damage to the unit < 500ms
		85-90Vac	
		60-85Vac	
		0-85Vac	
		264-300Vac	
Allowed voltage L or N to earth	max.	300Vac	continuous, IEC 62103
Input frequency	nom.	50–60Hz	±6%
Turn-on voltage	typ.	80Vac	steady-state value, load independent, see Fig. 3-1
Shut-down voltage	typ.	74Vac	steady-state value, load independent, see Fig. 3-1
External input protection	See recommendations in chapter 26.3.		

		AC 100V	AC 120V	AC 230V	
Input current	typ.	10.5A	8.6A	4.5A	at 24V, 40A, see Fig. 3-3
Power factor*)	typ.	0.99	0.99	0.99	at 24V, 40A, see Fig. 3-4
Crest factor**)	typ.	1.47	1.53	1.56	at 24V, 40A
Start-up delay	typ.	800ms	750ms	700ms	see Fig. 3-2
Rise time	typ.	15ms	15ms	15ms	at 24V, 40A, resistive load, 0mF see Fig. 3-2
	typ.	18ms	18ms	18ms	at 24V, 40A, resistive load, 40mF see Fig. 3-2
Turn-on overshoot	max.	100mV	100mV	100mV	see Fig. 3-2

\*) The power factor is the ratio of the true (or real) power to the apparent power in an AC circuit.

\*\*) The crest factor is the mathematical ratio of the peak value to RMS value of the input current waveform.

Fig. 3-1 Input voltage range

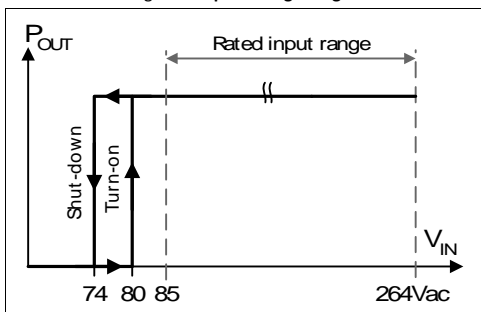

Fig. 3-3 Input current vs. output load at 24V

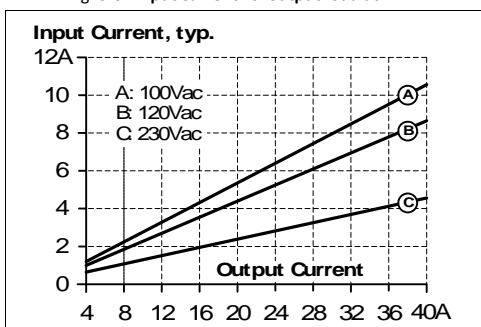

Fig. 3-2 Turn-on behaviour, definitions

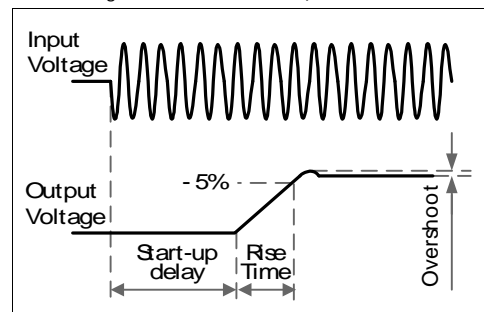
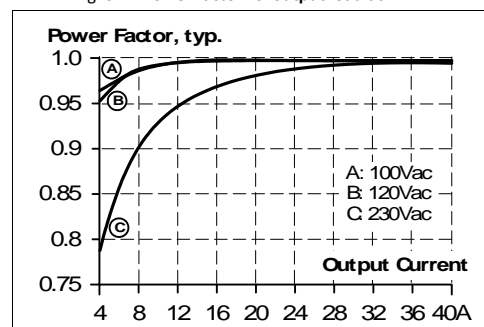

Fig. 3-4 Power factor vs. output load at 24V



### 4. INPUT INRUSH CURRENT

The power supply is equipped with an active inrush current limitation circuit, which limits the input inrush current after turn-on to a negligible low value. The input current is usually smaller than the steady state input current.

		AC 100V	AC 120V	AC 230V	
Inrush current*)	max.	25A <sub>peak</sub>	22A <sub>peak</sub>	16A <sub>peak</sub>	over entire temperature range; mains interruptions > 1s
	typ.	20A <sub>peak</sub>	17A <sub>peak</sub>	11A <sub>peak</sub>	over entire temperature range; mains interruptions > 1s
Inrush energy	max.	5A <sup>2</sup> s	5A <sup>2</sup> s	5A <sup>2</sup> s	over entire temperature range; mains interruptions > 1s

\*) The charging current into EMI suppression capacitors is disregarded in the first microseconds after switch-on.

Fig. 4-1 Typical turn-on behaviour at nominal load and 25°C ambient temperature

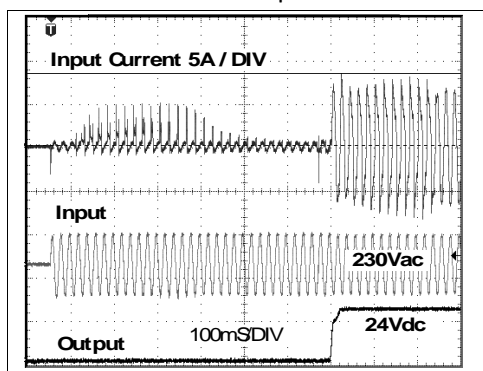

### 5. DC-INPUT

Do not operate this power supply with DC-input voltage. Check the CPS20.241-D1 unit instead. Two CPS20.241-D1 units in parallel might be necessary.

### 6. OUTPUT

Output voltage	nom.	DC 24V	
Adjustment range		24-28Vdc	guaranteed
	max.	29Vdc****)	at clockwise end position of potentiometer
Factory setting	typ.	24.1Vdc	±0.2%, at full load, cold unit, in "single use" mode
	typ.	24.1Vdc	±0.5%, at full load, cold unit, in "parallel use" mode
	typ.	25.1Vdc	at no load, cold unit, in "parallel use" mode
Line regulation	max.	10mV	85-300Vac
Load regulation	max.	50mV	in "single use" mode: static value, 0A→40A, see Fig. 6-1
	typ.	1000mV	in "parallel use" mode: static value, 0A→40A, see Fig. 6-2
Ripple and noise voltage	max.	100mVpp	20Hz to 20MHz, 50Ohm
Output current	nom.	40A	continuously available at 24V, see Fig. 6-1 and Fig. 6-2
	nom.	34.3A	continuously available at 28V, see Fig. 6-1 and Fig. 6-2
	nom.	60A	short term available BonusPower*), at 24V for typical 4s, see Fig. 6-1 and Fig. 6-2
	nom.	51.5A	short term available BonusPower*), at 28V for typical 4s, see Fig. 6-1 and Fig. 6-2
	typ.	110A	up to 10ms, output voltage stays above 20V, see Fig. 6-4, This peak current is available once every second. See chapter 26.2 for more peak current measurements.
Output power	nom.	960W	continuously available at 24-28V
	nom.	1440W*)	short term available BonusPower*) at 24-28V
BonusPower time	typ.	4s	duration until the output voltage dips, see Fig. 6-5
BonusPower recovery time	typ.	7s	overload free time to reset power manager, see Fig. 6-6
Overload behaviour		cont. current	output voltage > 20Vdc, see Fig. 6-1
		Hiccup <sup>PLUS</sup> mode**)	output voltage < 20Vdc, see Fig. 6-1
Short-circuit current	min.	60A****)	load impedance 25mOhm, see Fig. 6-3
	max.	70A****)	load impedance 25mOhm, see Fig. 6-3
	max.	23A	average (R.M.S.) current, load impedance 25mOhm, see Fig. 6-3
	typ.	130A	up to 10ms, load impedance <10mOhm, see Fig. 6-4
Output capacitance	typ.	10 200µF	included in the power supply

\*) **BonusPower, short term power capability (up to typ. 4s)**

The power supply is designed to support loads with a higher short-term power requirement without damage or shutdown. The short-term duration is hardware controlled by an output power manager. This BonusPower is repeatedly available. Detailed information can be found in chapter 26.1. If the power supply is loaded longer with the BonusPower than shown in the Bonus-time diagram (see Fig. 6-5), the max. output power is automatically reduced to 960W. If the power requirement is continuously above 960W and the voltage falls below approx. 20V (due to the current regulating mode at overload), the unit shuts-off and makes periodical restart attempts. This behaviour is called hiccup mode which is described below. If the voltage is above 20V, the unit continuously delivers current.

\*\*\*) **Hiccup<sup>PLUS</sup> Mode**

Up to 4s of overloading, the power supply delivers continuous output current. After this, the output power is reduced to nearly zero for approx. 17s before a new start attempt is automatically performed. If the overload has been cleared, the device will operate normally. If the overload still exists, the output current will be delivered for 2 to 4s (depending on the overload) again followed by a 17s rest time. This cycle is repeated as long as the overload exists. See Fig. 6-3. During the off period a small rest voltage and rest current is present on the output.

\*\*\*\*) Discharge current of output capacitors is not included.

\*\*\*\*\*) This is the maximum output voltage which can occur at the clockwise end position of the potentiometer due to tolerances. It is not guaranteed value which can be achieved. The typical value is about 28.5V.

Fig. 6-1 Output voltage vs. output current in "single use" mode, typ.

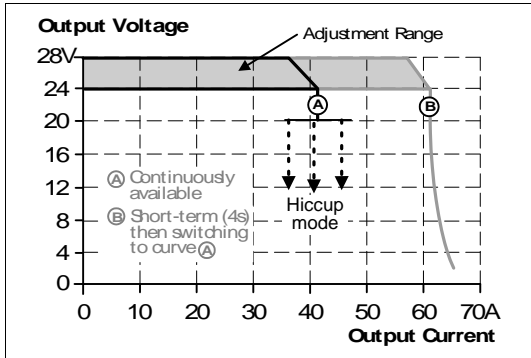

Fig. 6-2 Output voltage vs. output current in "parallel use" mode, typ.

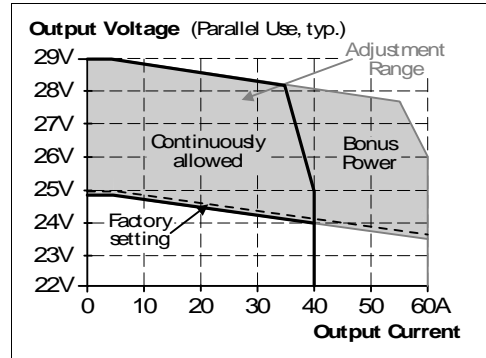

Fig. 6-3 Short-circuit on output, Hiccup<sup>PLUS</sup> mode, typ.

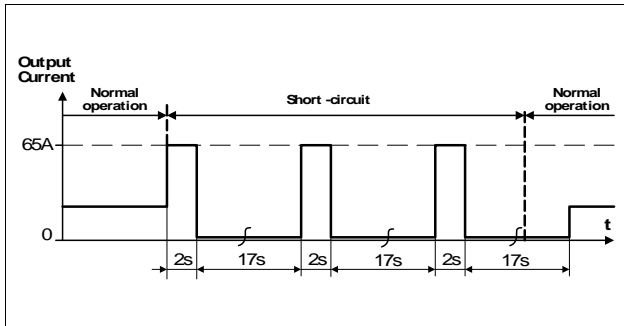

Fig. 6-4 Dynamic overcurrent capability, typ.

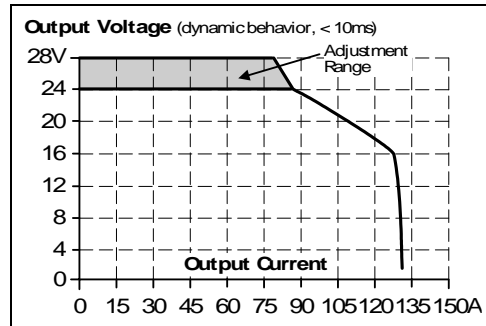

Fig. 6-5 Bonus time vs. output power

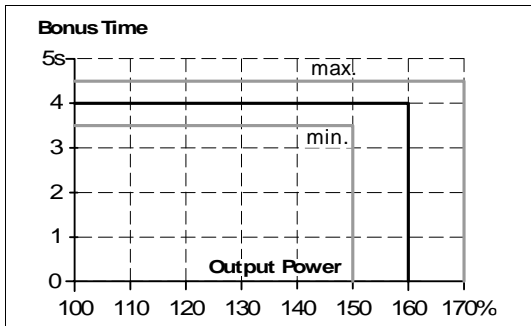
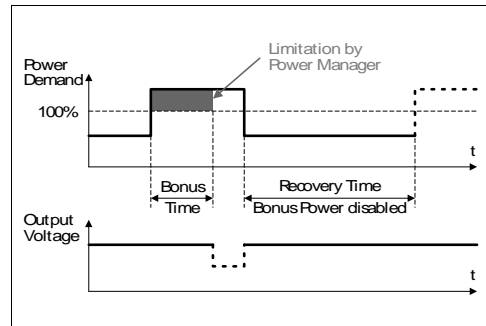

Fig. 6-6 BonusPower recovery time



The BonusPower is available as soon as power comes on and after the end of an output short circuit or output overload.

Fig. 6-7 BonusPower after input turn-on

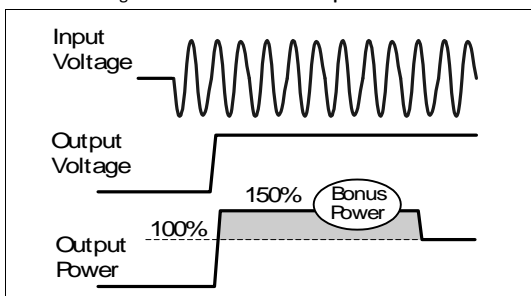
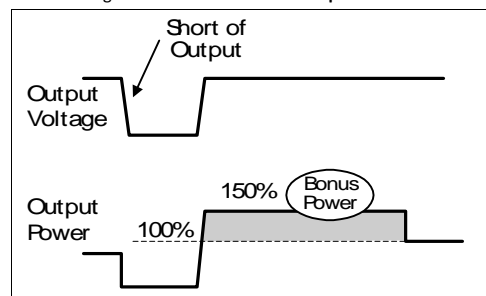

Fig. 6-8 BonusPower after output short





### 7. HOLD-UP TIME

		AC 100V	AC 120V	AC 230V	
Hold-up Time	typ.	54ms	54ms	54ms	at 24V, 20A, see Fig. 7-1
	min.	45ms	45ms	45ms	at 24V, 20A, see Fig. 7-1
	typ.	27ms	27ms	27ms	at 24V, 40A, see Fig. 7-1
	min.	23ms	23ms	23ms	at 24V, 40A, see Fig. 7-1

Fig. 7-1 Hold-up time vs. input voltage

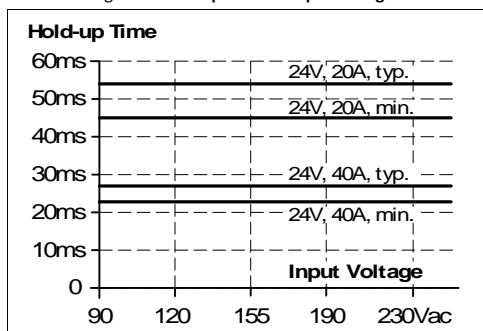
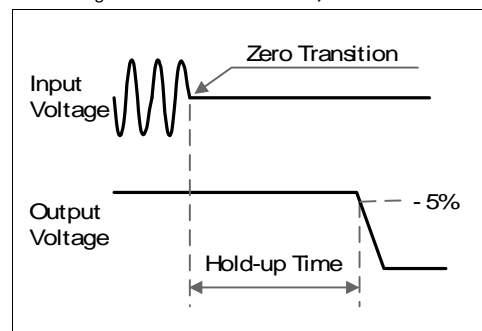

Fig. 7-2 Shut-down behaviour, definitions



### 8. DC-OK RELAY CONTACT

This feature monitors the output voltage, which is produced by the power supply itself. It is independent of a back-fed voltage from a unit connected in parallel to the power supply output.

Contact closes	As soon as the output voltage reaches 90% of the adjusted output voltage.		
Contact opens	As soon as the output voltage dips more than 10% below the adjusted output voltage. Short dips will be extended to a signal length of 250ms. Dips shorter than 1ms will be ignored.		
Contact re-closes	As soon as the output voltage exceeds 90% of the adjusted voltage.		
Contact ratings	max	60Vdc 0.3A, 30Vdc 1A, 30Vac 0.5A	resistive load
	min	1mA at 5Vdc	min. permissible load
Isolation voltage	See dielectric strength table in chapter 21.		

Fig. 8-1 DC-OK relay contact behavior

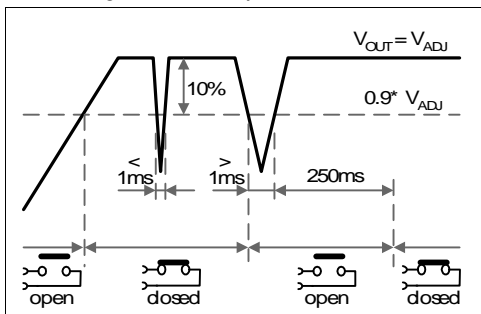

### 9. SHUT-DOWN INPUT

This feature allows a switch-off of the output of the power supply with a signal switch or an external voltage. The shut-down occurs immediately while the turn-on is delayed up to 350ms. In a shut-down condition, the output voltage is  $< 2V$  and the output power is  $< 0.5W$ .

The voltage between different minus pole output terminals must be below 1V when units are connected in parallel. In a series operation of multiple power supplies only wiring option "A" with individual signal switches is allowed.

Please note:

- Option C requires a current sink capability of the voltage source. Do not use a blocking diode.
- The shut-down function has no safety feature included.

Fig. 9-1 Activation of the shut-down input

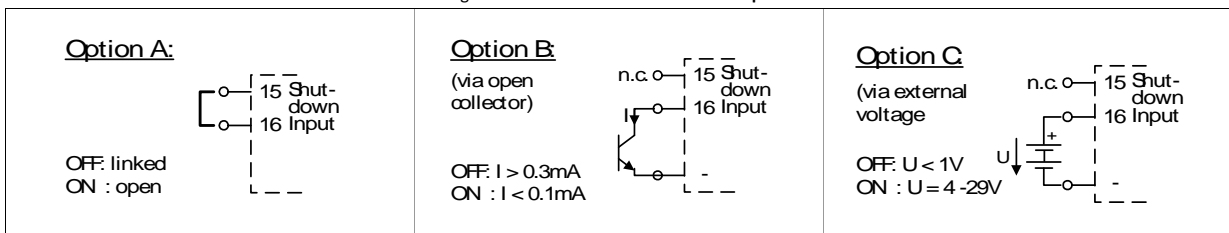

### 10. REMOTE CONTROL OF OUTPUT VOLTAGE

The shut-down input can also be used to remotely adjust the output voltage between typically 22Vdc and 28Vdc. All other functions of shut-down input remain the same.

The control voltage is referenced to the main ground (negative output voltage)

Fig. 10-1 Remote control of the output voltage

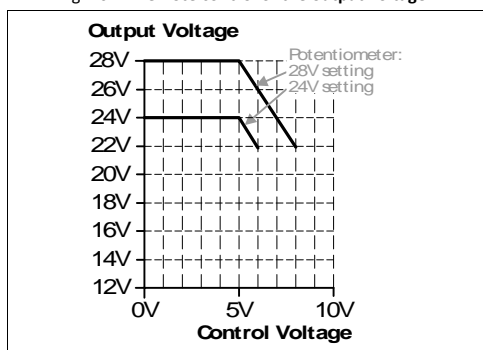
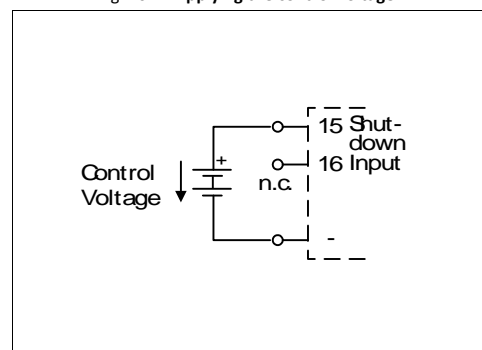

Fig. 10-2 Applying the control voltage



**Instructions:**

1. Set the unit into "Single Use" mode
2. Set the output voltage adjustment (24-28V) to the maximum desired voltage.
3. Apply a control voltage to reduce the output voltage

### 11. INTERNAL DATA LOGGING

A protected microcontroller inside the power supply acquires and stores operating data during the life of the unit. The data can be downloaded with a small tool and special software by the PULS service and repair personnel, even when the unit is defect. The data allows for better troubleshooting. Analysis of what happened before a failure can be determined much more accurately.

**Acquired data:**

- Family name of unit (QS40), revision of firmware
- Operational hours
- Expired portion of lifetime (combination of temperature and period of time)
- Maximum ambient temperatures with timestamp (max. 47 values)
- Maximal input voltages with timestamp (max. 47 values) and type of input voltage (AC or DC)
- Failure report (various internal errors)
- Number and timestamp of input overvoltage transients
- Number and timestamp of over-temperature shut-downs
- Number of turn-on sequences

The data will be acquired with a fixed sampling rate unless the peak detectors do trigger due to an abnormal condition. In such cases, the abnormal condition will be captured. Furthermore, data will be acquired every time shortly before the unit switches off.

### 12. EFFICIENCY AND POWER LOSSES

		AC 100V	AC 120V	AC 230V	
Efficiency	typ.	93.2%	93.6%	94.6%	at 24V, 40A
Average efficiency*)	typ.	92.7%	93.0%	93.9%	25% at 10A, 25% at 20A, 25% at 30A, 25% at 40A
Power losses	typ.	3.6W	3.5W	3.3W	with activated shut-down
	typ.	13.9W	13.1W	13.2W	at 24V, 0A (no load)
	typ.	36.1W	34.5W	30.6W	at 24V, 20A (half load)
	typ.	70.0W	65.6W	54.8W	at 24V, 40A (full load)

\*) The average efficiency is an assumption for a typical application where the power supply is loaded with 25% of the nominal load for 25% of the time, 50% of the nominal load for another 25% of the time, 75% of the nominal load for another 25% of the time and with 100% of the nominal load for the rest of the time.

Fig. 12-1 Efficiency vs. output current at 24V, typ.

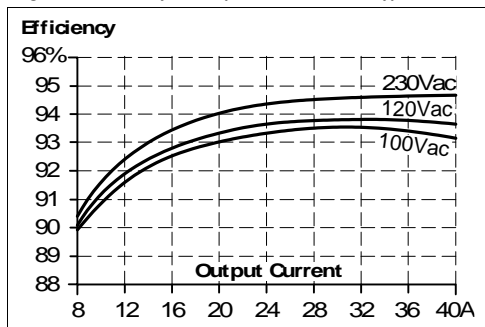

Fig. 12-2 Losses vs. output current at 24V, typ.

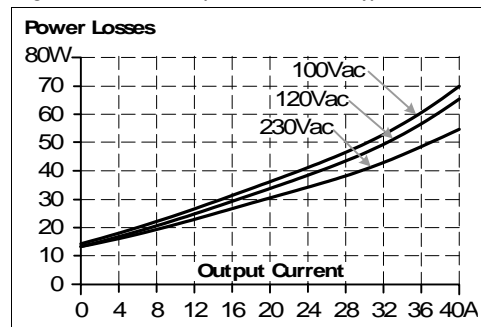

Fig. 12-3 Efficiency vs. input voltage at 24V, 40A, typ.

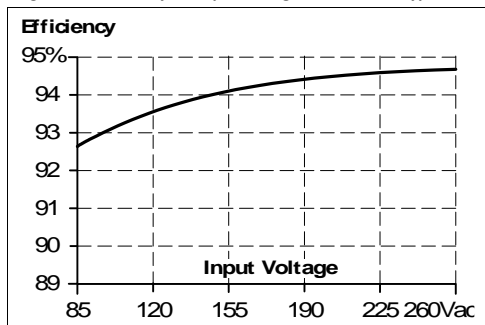
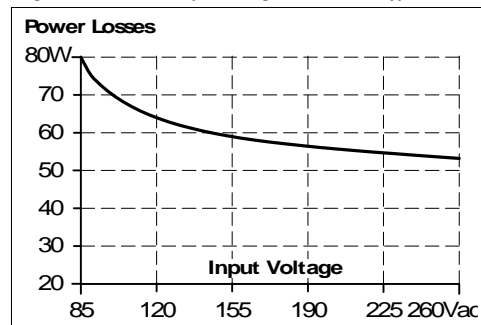

Fig. 12-4 Losses vs. input voltage at 24V, 40A, typ.



### 13. LIFETIME EXPECTANCY AND MTBF

	AC 100V	AC 120V	AC 230V	
Calculated lifetime expectancy <sup>*)</sup>	288 000h <sup>*)</sup>	291 000h <sup>*)</sup>	317 000h <sup>*)</sup>	at 24V, 20A and 25°C
	102 000h	103 000h	112 000h	at 24V, 20A and 40°C
	163 000h <sup>*)</sup>	181 000h <sup>*)</sup>	238 000h <sup>*)</sup>	at 24V, 40A and 25°C
	57 000h	64 000h	84 000h	at 24V, 40A and 40°C
MTBF <sup>**) SN 29500, IEC 61709</sup>	491 000h	481 000h	537 000h	at 24V, 40A and 25°C
	274 000h	269 000h	300 000h	at 24V, 40A and 40°C
MTBF <sup>**) MIL HDBK 217F Ground Benign</sup>	170 000h	171 000h	183 000h	at 24V, 40A and 25°C; Ground Benign GB25
	126 000h	127 000h	137 000h	at 24V, 40A and 40°C; Ground Benign GB40
MTBF <sup>**) MIL HDBK 217F Ground Fixed</sup>	36 000h	36 000h	39 000h	at 24V, 40A and 25°C; Ground Fixed GF25
	27 000h	27 000h	30 000h	at 24V, 40A and 40°C. Ground Fixed GF40

\*) The **calculated lifetime expectancy** shown in the table indicates the minimum operating hours (service life) and is determined by the lifetime expectancy of the built-in electrolytic capacitors. Lifetime expectancy is specified in operational hours and is calculated according to the capacitor's manufacturer specification. The manufacturer of the electrolytic capacitors only guarantees a maximum life of up to 15 years (131 400h). Any number exceeding this value is a calculated theoretical lifetime which can be used to compare devices.

\*\*) **MTBF** stands for **Mean Time Between Failure**, which is calculated according to statistical device failures, and indicates reliability of a device. It is the statistical representation of the likelihood of a unit to fail and does not necessarily represent the life of a product.

The MTBF figure is a statistical representation of the likelihood of a device to fail. A MTBF figure of e.g. 1 000 000h means that statistically one unit will fail every 100 hours if 10 000 units are installed in the field. However, it can not be determined if the failed unit has been running for 50 000h or only for 100h.

### 14. FUNCTIONAL DIAGRAM

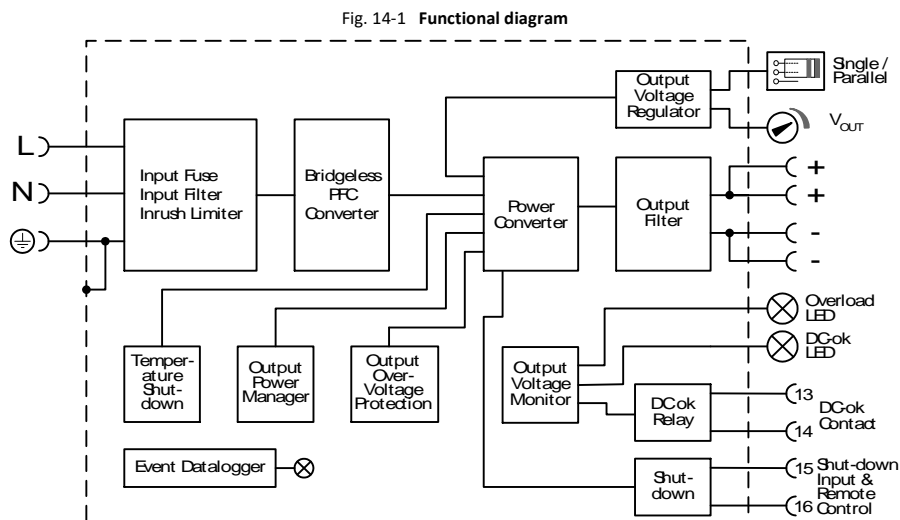

### 15. TERMINALS AND WIRING

The terminals are IP20 Finger safe constructed and suitable for field and factory wiring.

	<b>Input</b>	<b>Output</b>	<b>DC-OK, Shut-down</b>
<b>Type</b>	screw terminal	screw terminal	spring-clamp terminal
Solid wire	0.5-6mm <sup>2</sup>	0.5-16mm <sup>2</sup>	0.15-1.5mm <sup>2</sup>
Stranded wire	0.5-4mm <sup>2</sup>	0.5-10mm <sup>2</sup>	0.15-1.5mm <sup>2</sup>
American Wire Gauge	AWG 20-10	AWG 22-8	AWG 26-14
Max. wire diameter	2.8mm (including ferrules)	5.2mm (including ferrules)	1.5mm (including ferrules)
Wire stripping length	7mm	12mm	7mm
Screwdriver	3.5mm slotted or crosshead No 2	3.5mm or 5mm slotted or crosshead No 2	3mm slotted (to open the spring)
Recommended tightening torque	1Nm	2.3Nm	Not applicable

**Instructions:**

- a) Use appropriate copper cables that are designed for minimum operating temperatures of:  
60°C for ambient up to 45°C and  
75°C for ambient up to 60°C minimum  
90°C for ambient up to 70°C minimum.
- b) Follow national installation codes and installation regulations!
- c) Ensure that all strands of a stranded wire enter the terminal connection!
- d) Do not use the unit without PE connection.
- e) Unused terminal compartments should be securely tightened.
- f) Ferrules are allowed.

**Daisy chaining:**

Daisy chaining (jumping from one power supply output to the next) is allowed as long as the average output current through one terminal pin does not exceed 54A. If the current is higher, use a separate distribution terminal block as shown in Fig. 15-2.

Fig. 15-1 Daisy chaining of outputs

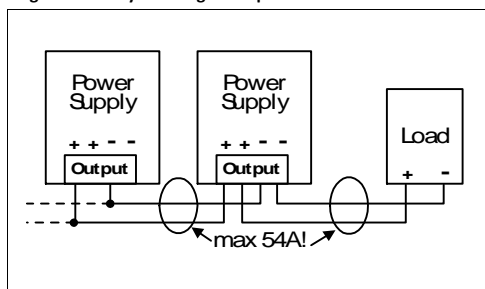
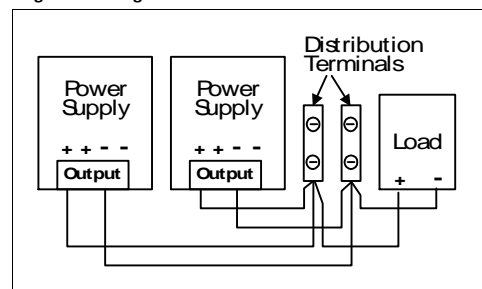
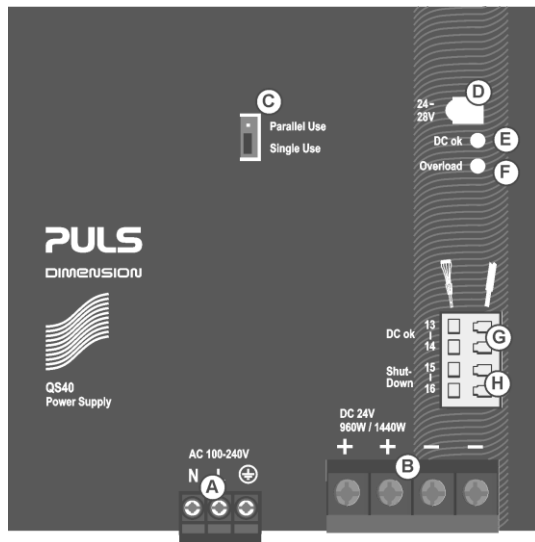

Fig. 15-2 Using distribution terminals



### 16. FRONT SIDE AND USER ELEMENTS

Fig. 16-1 Front side



**A Input Terminals** (Screw terminals)

**N, L** Line input

$\oplus$  ...PE (Protective Earth) input

**B Output Terminals** (Screw terminals, two pins per pole)

**+** Positive output

**-** Negative (return) output

**C “Parallel Use” “Single Use” Selector**

Set jumper to “Parallel Use” when power supplies are connected in parallel to increase the output power. In order to achieve a sharing of the load current between the individual power supplies, the “parallel use” regulates the output voltage in such a manner that the voltage at no load is approx. 4% higher than at nominal load. See also chapter 26.6. A missing jumper is equal to a “Single Use” mode.

**D Output Voltage Potentiometer**

Multi turn potentiometer;

Open the flap to set the output voltage.

Factory set: 24.1V at full output current, “Single Use” mode.

**E DC-OK LED** (green)

On, when the voltage on the output terminals is >90% of the adjusted output voltage

**F Overload LED** (red)

- On, when the voltage on the output terminals is <90% of the adjusted output voltage, or in case of a short circuit in the output.
- Flashing, when the shut-down has been activated or the unit has switched off due to over-temperature.
- Input voltage is required

**G DC-OK Relay Contact**

The DC-OK relay contact is synchronized with the DC-OK LED. See chapter 8 for details.

**H Shut-down and Remote-Control Input**

Allows the power supply to be shut down. Can be activated with a switch contact or an external voltage.

The remote-control input allows adjusting the output voltage between 22V and 28V. See chapter 9 and 10 for details.

**Indicators, LEDs**

	Overload LED	DC-OK LED	DC-OK Contact
Normal mode	OFF	ON	Closed
During BonusPower	OFF	ON	Closed
Overload (Hiccup mode)	flashing	OFF	Open
Output short circuit	flashing	OFF	Open
Temperature Shutdown	flashing	OFF	Open
Active Shut-down input	flashing	OFF	Open
No input power	OFF	OFF	Open

### 17. EMC

The power supply is suitable for applications in industrial environment as well as in residential, commercial and light industry environment without any restrictions. A detailed EMC report is available on request.

EMC Immunity	According generic standards: EN 61000-6-1 and EN 61000-6-2			
Electrostatic discharge	EN 61000-4-2	contact discharge	8kV	Criterion A
		air discharge	15kV	Criterion A
Electromagnetic RF field	EN 61000-4-3	80MHz-2.7GHz	20V/m	Criterion A
Fast transients (Burst)	EN 61000-4-4	input lines	4kV	Criterion A
		output lines	2kV	Criterion A
		signal lines (coupling clamp)	2kV	Criterion A
Surge voltage on input	EN 61000-4-5	L → N	2kV	Criterion A
		L → PE, N → PE	4kV	Criterion A
Surge voltage on output	EN 61000-4-5	+ → -	1kV	Criterion A
		+ / - → PE	1kV	Criterion A
Surge voltage on signal lines	EN 61000-4-5	DC-OK signal → PE	1kV	Criterion A
	EN 61000-4-5	Shut-down input → PE	not relevant due to wire length **)	
Conducted disturbance	EN 61000-4-6	0.15-80MHz	20V	Criterion A
Mains voltage dips	EN 61000-4-11	0% of 100Vac	0Vac, 20ms	Criterion A
		40% of 100Vac	40Vac, 200ms	Criterion C
		70% of 100Vac	70Vac, 500ms	Criterion A
		0% of 200Vac	0Vac, 20ms	Criterion A
		40% of 200Vac	80Vac, 200ms	Criterion A
		70% of 200Vac	140Vac, 500ms	Criterion A
Voltage interruptions	EN 61000-4-11	0% of 200Vac (=0V)	5000ms	Criterion C
Voltage sags	SEMI F47	dips on the input voltage according to SEMI F47 standard		
		80% of 120Vac (96Vac)	1000ms	Criterion A
		70% of 120Vac (84Vac)	500ms	Criterion A
		50% of 120Vac (60Vac)	200ms	Criterion A
Powerful transients	VDE 0160	over entire load range	750V, 1.3ms	Criterion B <sup>*)</sup>

\*) Criterion A is fulfilled for output current up to 30A.

\*\*) Do not use longer wires than 30m for the shut-down input or use an additional protection.

**Criteria:**

**A:** Power supply shows normal operation behavior within the defined limits.

**B:** Output voltage will dip from 24V to 21V for 5ms

**C:** Temporary loss of function is possible. Power supply may shut down and restarts by itself. No damage or hazards for the power supply will occur.

EMC Emission	According generic standards: EN 61000-6-3 and EN 61000-6-4	
Conducted emission input lines	EN 55011, EN 55032, FCC Part 15, CISPR 11, CISPR 32	Class B
Conducted emission output lines	IEC/CISPR 16-1-2, IEC/CISPR 16-2-1	10dB higher than average limits for DC power port according EN 61000-6-3****)
Radiated emission	EN 55011, EN 55032	Class B
Harmonic input current	EN 61000-3-2	fulfilled for class A equipment
Voltage fluctuations, flicker	EN 61000-3-3	fulfilled**)

This device complies with FCC Part 15 rules.

Operation is subjected to following two conditions: (1) this device may not cause harmful interference, and (2) this device must accept any interference received, including interference that may cause undesired operation.

\*\*) Tested with constant current loads, non pulsing

\*\*\*\*) Restrictions apply for applications in residential, commercial and light-industrial environments, where local DC power networks according to EN 61000-6-3 are involved. No restrictions for all kinds of industrial applications.



<b>Switching Frequencies</b>	The power supply has four converters with four different switching frequencies included. One is nearly constant. The others are input voltage and load dependent.	
Switching frequency 1	105kHz	Resonant converter, nearly constant
Switching frequency 2	1kHz to 150kHz	Boost converter, input voltage and load dependent
Switching frequency 3	1kHz to 100kHz	PFC converter, input voltage and load dependent
Switching frequency 4	25kHz to 45kHz	Aux. converter, input voltage and load dependent

## 18. ENVIRONMENT

Operational temperature*)	-25°C to +70°C	reduce output power according Fig. 18-1
Storage temperature	-40 to +85°C	for storage and transportation
Output derating	24W/°C	60-70°C
Humidity**)	5 to 95% r.H.	IEC 60068-2-30
Vibration sinusoidal	2-17.8Hz: ±1.6mm; 17.8-500Hz: 1g ***) 2 hours / axis	IEC 60068-2-6
Shock	15g 6ms, 10g 11ms ***) 3 bumps / direction, 18 bumps in total	IEC 60068-2-27
Altitude	0 to 2000m 2000 to 6000m	without any restrictions reduce output power or ambient temperature, see Fig. 18-2 IEC 62103, EN 50178, overvoltage category II
Altitude derating	60W/1000m or 5°C/1000m	> 2000m, see Fig. 18-2
Over-voltage category	III II	IEC 62103, EN 50178, altitudes up to 2000m altitudes from 2000m to 6000m
Degree of pollution	2	IEC 62103, EN 50178, not conductive

\*) Operational temperature is the same as the ambient or surrounding temperature and is defined as the air temperature 2cm below the unit.

\*\*\*) Do not energize while condensation is present.

\*\*\*\*) Higher levels allowed when using the wall mounting bracket ZM2.WALL

Fig. 18-1 Output current vs. ambient temp.

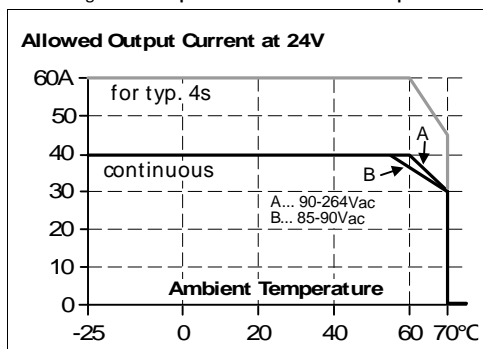
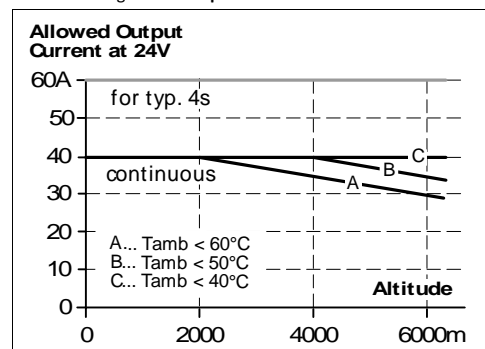

Fig. 18-2 Output current vs. altitude



### 19. PROTECTION FEATURES

Output protection	Electronically protected against overload, no-load and short-circuits <sup>*)</sup>	
Output over-voltage protection	typ. 30Vdc max. 32Vdc	In case of an internal power supply defect, a redundant circuit limits the maximum output voltage. The output shuts down and automatically attempts to restart.
Degree of protection	IP 20	EN/IEC 60529 Caution: For use in a controlled environment according to CSA 22.2 No 107.1-01.
Penetration protection	> 5mm	e.g. screws, small parts
Over-temperature protection	yes	Output shutdown with automatic restart
Input transient protection	MOV (Metal Oxide Varistor)	
Internal input fuse	included	not user replaceable

<sup>\*)</sup> In case of a protection event, audible noise may occur.

### 20. SAFETY FEATURES

Input / output separation <sup>*)</sup>	SELV PELV double or reinforced insulation	IEC/EN 60950-1 IEC/EN 60204-1, EN 50178, IEC 62103, IEC 60364-4-41
Class of protection	I	PE (Protective Earth) connection required
Isolation resistance	> 100MΩ	input to output, 500Vdc
PE resistance	< 0.1Ω	
Touch current (leakage current)	typ. 0.39mA / 1.0mA typ. 0.56mA / 1.43mA typ. 0.90mA / 2.25mA max. 0.50mA / 1.21mA max. 0.71mA / 1.73mA max. 1.18mA / 2.82mA	100Vac, 50Hz, TN-,TT-mains / IT-mains 120Vac, 60Hz, TN-,TT-mains / IT-mains 230Vac, 50Hz, TN-,TT-mains / IT-mains 110Vac, 50Hz, TN-,TT-mains / IT-mains 132Vac, 60Hz, TN-,TT-mains / IT-mains 264Vac, 50Hz, TN-,TT-mains / IT-mains

<sup>\*)</sup> double or reinforced insulation

### 21. DIELECTRIC STRENGTH

The output voltage is floating and has no ohmic connection to the ground. Type and factory tests are conducted by the manufacturer. Field tests may be conducted in the field using the appropriate test equipment which applies the voltage with a slow ramp (2s up and 2s down). Connect all input-terminals together as well as all output poles before conducting the test. When testing, set the cut-off current settings to the value in the table below.

Fig. 21-1 Dielectric strength

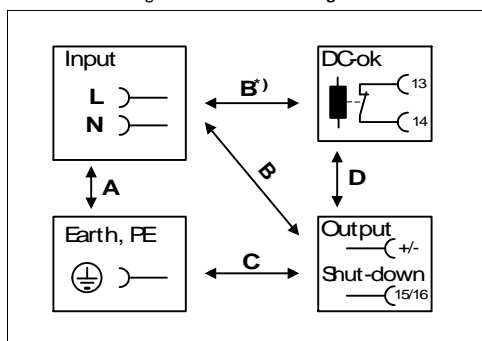

		A	B	C	D
Type test	60s	2500Vac	3000Vac	500Vac	500Vac
Factory test	5s	2500Vac	2500Vac	500Vac	500Vac
Field test	5s	2000Vac	2000Vac	500Vac	500Vac
Cut-off current setting		> 20mA	> 20mA	> 40mA	> 1mA

To fulfil the PELV requirements according to EN60204-1 § 6.4.1, we recommend that either the + pole, the – pole or any other part of the output circuit shall be connected to the protective earth system. This helps to avoid situations in which a load starts unexpectedly or can not be switched off when unnoticed earth faults occur.

B\*) When testing input to DC-OK ensure that the max. voltage between DC-OK and the output is not exceeded (column D). We recommend connecting DC-OK pins and the output pins together when performing the test.

### 22. APPROVED, FULFILLED OR TESTED STANDARDS

UL 508		UL Certificate Listed equipment for category NMTR - Industrial Control Equipment Applicable for US and Canada E-File: E198865
IEC 61010-2-201 (only QS40.241)		Manufacturer's Declaration Electrical Equipment for Measurement, Control and Laboratory Use - Particular requirements for control equipment
IEC 60950-1		CB Scheme Certificate General safety requirements for Information Technology Equipment (ITE)
UL 60950-1		UL Certificate Recognized component for category QQGQ - Information Technology Equipment (ITE) Applicable for US and Canada E-File: E137006
ATEX		Agency Certificate (Bureau Veritas) EN 60079-0 Explosive atmospheres - General requirements EN 60079-7, EN 60079-15 Equipment protection by type of protection "e" and "n" Certificate: EPS 14 ATEX 1 638 X Temperature Code: T4 Type of Protection: ec nC
IECEX		IECEX Certificate IEC 60079-0 Explosive atmospheres - General requirements IEC 60079-7, IEC 60079-15 Equipment protection by type of protection "e" and "n" Certificate: IECEX EPS 14.0007 X Temperature Code: T4 Type of Protection: ec nC
Class I Div 2 (only QS40.241)		CSA Certificate Power Supplies for Hazardous Location Applicable for Canada and US CSA Class: 5318-01 (Canada), 5318-81 (USA) Temperature Code: T4 Groups: A, B, C and D
Marine (DNV) (only QS40.241)		DNV Certificate DNV Type approved product Certificate: TAA00002JT Temperature: Class D Humidity: Class B Vibration: Class C EMC: Class A Enclosure: Class A
Marine (ABS) (only QS40.241)		ABS Design Assessment Certificate ABS (American Bureau of Shipment) assessed product Certificate: 22-2231447-PDA
IEC 60068-2-60 (only QS40.241)		Manufacturer's Declaration (Online Document) Environmental Tests, Flowing Mixed Gas Corrosion Test Test Ke - Method 4 H2S: 10ppb NO2: 200ppb Cl2: 10ppb SO2: 200ppb Test Duration: 3 weeks, which simulates a service life of 10 years

ISA-71.04-1985  
(only QS40.241)

**Corrosion**  
**G3-ISA-71.04** ✓

Manufacturer's Declaration (Online Document)  
Airborne Contaminants Corrosion Test  
Severity Level: G3 Harsh  
H2S: 100ppb  
NOx: 1250ppb  
Cl2: 20ppb  
SO2: 300ppb  
Test Duration: 3 weeks, which simulates a service life of 10 years.

VDMA 24364

**LABS**  
VDMA 24364-C1-L/W

Paint Wetting Impairment Substances Test (or LABS-Test)  
Tested for Zone 2 and test class C1 according to VDMA 24364-C1-L/W for solvents and water-based paints

### 23. REGULATORY PRODUCT COMPLIANCE

EU Declaration of Conformity



The CE mark indicates conformance with the European  
- EMC directive  
- ATEX directive  
- RoHS directive

REACH Regulation (EU)



Manufacturer's Declaration  
EU regulation regarding the Registration, Evaluation, Authorisation and Restriction of Chemicals (REACH) fulfilled.  
EU Regulation (EC) 1907/2006.

WEEE Regulation



Manufacturer's Declaration  
EU Regulation on Waste Electrical and Electronic Equipment  
Registered as business to business (B2B) products.  
EU Regulation 2012/19/EU

UKCA



UKCA Declaration of Conformity  
Trade conformity assessment for England, Scotland and Wales  
The UKCA mark indicates conformity with the UK Statutory Instruments  
2016 No.1107,  
2016 No.1091,  
2012 No.3032

CCC



CCC Certificate  
China Compulsory Certification (CNCA-C23-01:2019)  
Certificate for devices made in Suzhou/China (PULS Electronics):  
2021122303114740  
Certificate for devices made in Chomutov/Czech Republic (PULS investiční):  
2021122303114741  
CCC-Ex

KC



KC Korean Certification  
Korean - Registration of Broadcasting and Communication Equipment  
Registered under Clause3, Article 58-2 of Radio Waves Act.  
Registration No. R-R-PUG-QS40\_241.

### 24. PHYSICAL DIMENSIONS AND WEIGHT

Width	125mm
Height	124mm
Depth	127mm The DIN rail depth must be added to the unit depth to calculate the total required installation depth.
Weight	1900g
DIN rail	Use 35mm DIN rails according to EN 60715 or EN 50022 with a height of 7.5 or 15mm.
Housing material	Aluminium body, Steel cover
Installation clearances	See chapter 2

Fig. 24-1 Front view

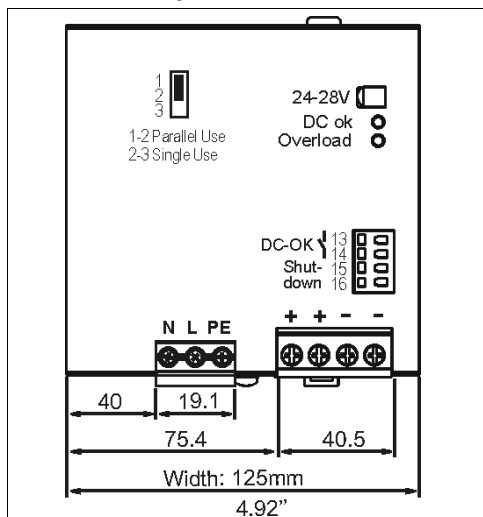
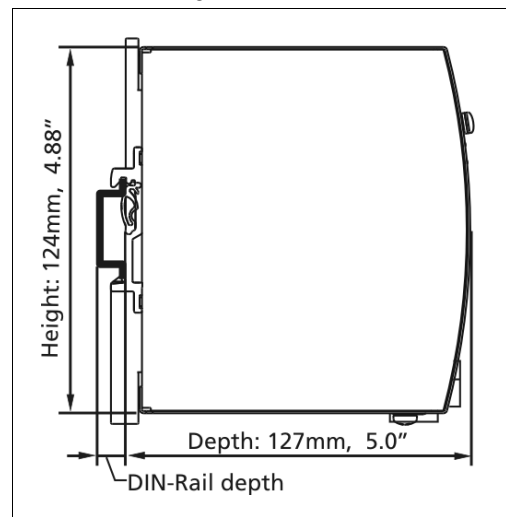

Fig. 24-2 Side view



### 25. ACCESSORIES

#### 25.1. ZM2.WALL - WALL MOUNTING BRACKET

This bracket is used to mount specific DIMENSION units onto a flat surface without utilizing a DIN rail.

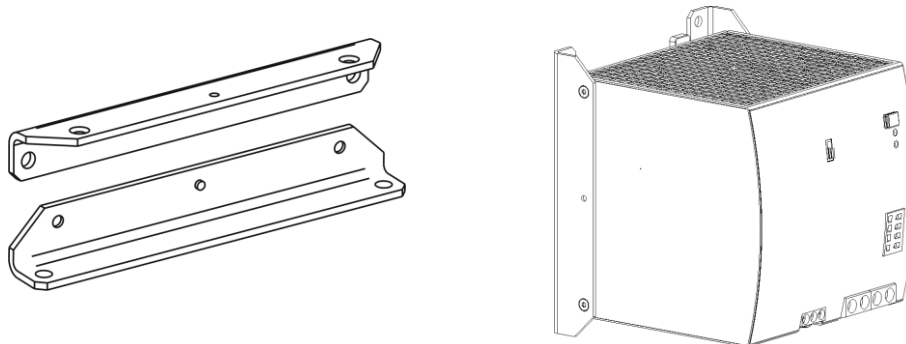

#### 25.2. UF20.241 - BUFFER MODULE



This buffer unit is a supplementary device for DC 24V power supplies. It delivers power to bridge typical mains failures or extends the hold-up time after turn-off of the AC power. In times when the power supply provides sufficient voltages, the buffer unit stores energy in integrated electrolytic capacitors. In case of mains voltage fault, this energy is released again in a regulated process. One buffer module can deliver 20A. To buffer the full output current of 40A, two buffer modules are needed in parallel.

The buffer unit does not require any control wiring. It can be added in parallel to the load circuit at any given point. Buffer units can be added in parallel to increase the output ampacity or the hold-up time.

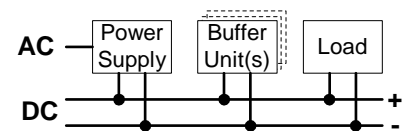

### 25.3. YR80.242 - REDUNDANCY MODULE



The YR80.242 is equipped with two input channels (40A each), which are individually decoupled by utilizing mosfet technology. The output current can go as high as 80A. Using mosfets instead of diodes reduces the heat generation and the voltage drop between input and output. The YR80.242 does not require an additional auxiliary voltage and is self-powered even in case of a short circuit across the output.

Due to the low power losses, the unit is very slender and only requires 46mm width on the DIN rail.

### 25.4. YR40.245 - REDUNDANCY MODULE



The YR40.245 is a 40A single channel redundancy module, which is equipped with a plug connector on the output. The plug connector allows replacing the power supply or the redundancy module while the system is running. The plug connector avoids that the output wires can touch and short the load circuit.

The YR40.245 is very slender and only requires 46mm width on the DIN rail. It also utilizes mosfets technology instead of diodes for low heat generation and a minimal voltage drop between input and output. It does not require an additional auxiliary voltage and is self-powered even in case of a short circuit across the output.

Fig. 25-1 Typical 1+1 Redundant configuration for 40A with a dual redundancy module

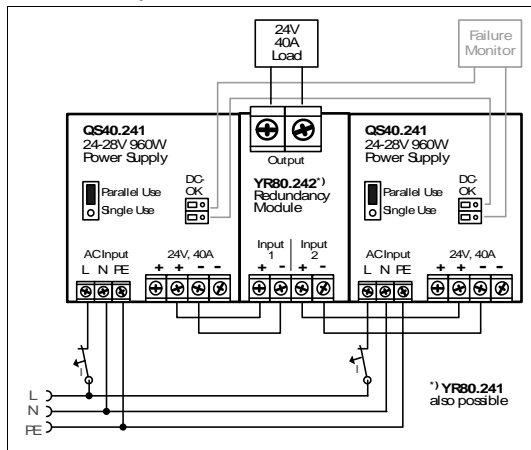
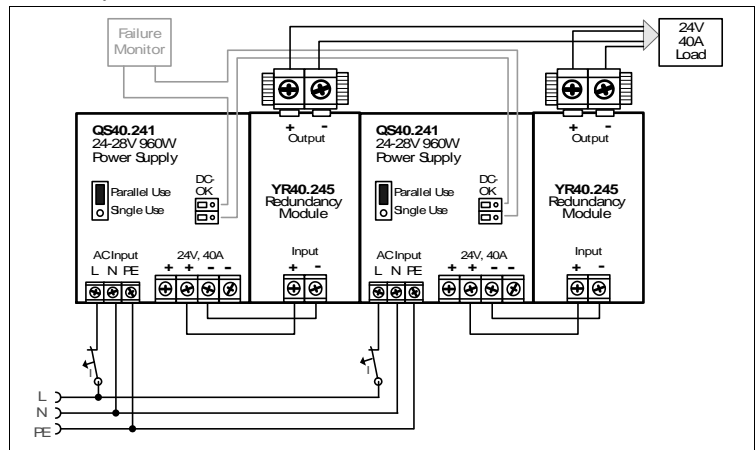

Fig. 25-2 Typical N+1 or 1+1 Redundant configuration for 40A with multiple YR40.245 redundancy modules





## 26. APPLICATION NOTES

### 26.1. REPETITIVE PULSE LOADING

Typically, a load current is not constant and varies over time. This power supply is designed to support loads with a higher short-term power demand (=BonusPower). The short-term duration is hardware controlled by an output power manager and is available on a repeated basis. If the BonusPower load lasts longer than the hardware controller allows it, the output voltage will dip and the next BonusPower is available after the BonusPower recovery time (see chapter 6) has elapsed.

To avoid this, the following rules must be met:

- The power demand of the pulse must be below 150% of the nominal output power.
- The duration of the pulse power must be shorter than the allowed BonusPower time. (see output chapter)
- The average (R.M.S.) output current must be below the specified continuous output current.  
If the R.M.S. current is higher, the unit will respond with a thermal shut-down after a period of time. Use the maximum duty cycle curve (Fig. 26-2) to check if the average output current is below the nominal current.
- The duty cycle must be below 0.75.

Fig. 26-1 Repetitive pulse loads, definitions

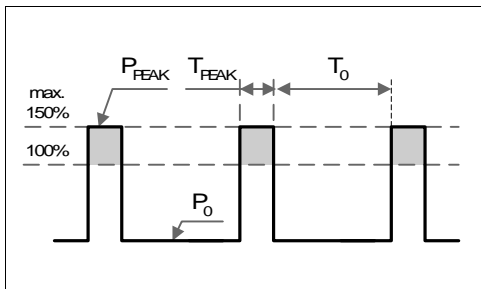

- P<sub>0</sub> Base load (W)
- P<sub>PEAK</sub> Pulse load (above 100%)
- T<sub>0</sub> Duration between pulses (s)
- T<sub>PEAK</sub> Pulse duration (s)

Fig. 26-2 Max. duty cycle curve

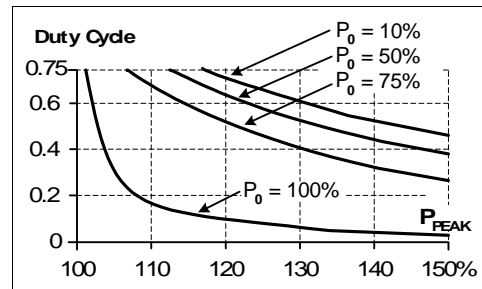

$$\text{DutyCycle} = \frac{T_{\text{peak}}}{T_{\text{peak}} + T_0}$$

$$T_0 = \frac{T_{\text{peak}} - (\text{DutyCycle} \times T_{\text{peak}})}{\text{DutyCycle}}$$

**Example:** A load is powered continuously with 480W (= 50% of the rated output load). From time to time a peak power of 1440W (= 150% of the rated output load) is needed for 1 second.

The question is: How often can this pulse be supplied without overloading the power supply?

- Make a vertical line at P<sub>PEAK</sub> = 150% and a horizontal line where the vertical line crosses the P<sub>0</sub> = 50% curve. Read the max. duty cycle from the duty cycle-axis (= 0.37)
- Calculate the required pause (base load) length T<sub>0</sub>:
- Result: The required pause length = 1.7s
- Max. repetition rate = pulse +pause length = **2.7s**

$$T_0 = \frac{T_{\text{peak}} - (\text{DutyCycle} \times T_{\text{peak}})}{\text{DutyCycle}} = \frac{1\text{s} - (0.37 \times 1\text{s})}{0.37} = 1.7\text{s}$$

**More examples for pulse load compatibility:**

P <sub>PEAK</sub>	P <sub>0</sub>	T <sub>PEAK</sub>	T <sub>0</sub>
1440W	960W	1s	>25s
1440W	0W	1s	>1.3s
1200W	480W	1s	> 0.75s
1440W	480W	0.1s	>0.16s
1440W	480W	1s	>1.6s
1440W	480W	3s	>4.9s

### 26.2. PEAK CURRENT CAPABILITY

The power supply can deliver peak currents (up to several milliseconds) which are higher than the specified short-term currents.

This helps to start current demanding loads. Solenoids, contactors and pneumatic modules often have a steady state coil and a pick-up coil. The inrush current demand of the pick-up coil is several times higher than the steady-state current and usually exceeds the nominal output current (including the BonusPower). The same situation applies when starting a capacitive load.

The peak current capability also ensures the safe operation of subsequent circuit breakers of load circuits. The load branches are often individually protected with circuit breakers or fuses. In case of a short or an overload in one branch circuit, the fuse or circuit breaker need a certain amount of over-current to open in a timely manner. This avoids voltage loss in adjacent circuits.

The extra current (peak current) is supplied by the power converter and the built-in large sized output capacitors of the power supply. The capacitors get discharged during such an event, which causes a voltage dip on the output. The following two examples show typical voltage dips:

Fig. 26-3 Peak load with 2x the nominal current for 50ms, typ.

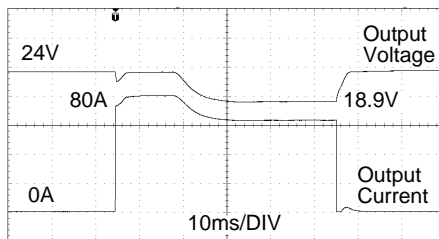

80A Peak load (resistive) for 50ms  
Output voltage dips from 24V to 18.9V.

Fig. 26-4 Peak load with 5x the nominal current for 5ms, typ.

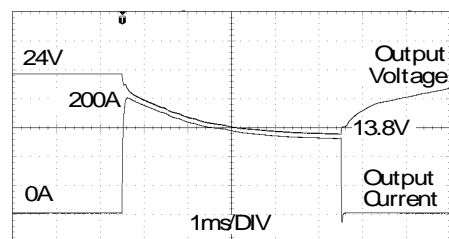

200A Peak load (resistive) for 5ms  
Output voltage dips from 24V to 13.8V.

Please note: The DC-OK relay triggers when the voltage dips more than 10% for longer than 1ms.

Peak current voltage dips	typ.	from 24V to 18.9V	at 80A for 50ms, resistive load
	typ.	from 24V to 15.9V	at 200A for 2ms, resistive load
	typ.	from 24V to 13.8V	at 200A for 5ms, resistive load

### 26.3. EXTERNAL INPUT PROTECTION

The unit is tested and approved for branch circuits up to 30A (U.S.A.) and 32A (IEC). An external protection is only required if the supplying branch has an ampacity greater than this. Check also local codes and local requirements. In some countries local regulations might apply.

If an external fuse is necessary or utilized, minimum requirements need to be considered to avoid nuisance tripping of the circuit breaker. A minimum value of 16A B- or C-Characteristic breaker should be chosen, when the unit is used at AC100 and AC120V mains voltages (including AC 230V). If the unit is used only at AC 230V mains, a 10A B- or C-Characteristic breaker is sufficient.

### 26.4. CHARGING OF BATTERIES

The power supply can be used to charge lead-acid or maintenance free batteries. (Two 12V batteries in series)

**Instructions for charging batteries:**

- a) Set output voltage (measured at no load and at the battery end of the cable) very precisely to the end-of-charge voltage.

End-of-charge voltage	27.8V	27.5V	27.15V	26.8V
Battery temperature	10°C	20°C	30°C	40°C

- b) Use a 50A or 63A circuit breaker (or blocking diode) between the power supply and the battery.
- c) Ensure that the output current of the power supply is below the allowed charging current of the battery.
- d) Use only matched batteries when putting 12V types in series.
- e) The return current to the power supply (battery discharge current) is typ. 35mA when the power supply is switched off (except in case a blocking diode is utilized).

### 26.5. OUTPUT CIRCUIT BREAKERS

Standard miniature circuit breakers (MCB's or UL1077 circuit breakers) are commonly used for AC-supply systems and may also be used on DC branches.

MCB's are designed to protect wires and circuits. If the ampere value and the characteristics of the MCB are adapted to the wire size that is used, the wiring is considered as thermally safe regardless of whether the MCB opens or not.

To avoid voltage dips and under-voltage situations in adjacent 24V branches which are supplied by the same source, a fast (magnetic) tripping of the MCB is desired. A quick shutdown within 10ms is necessary corresponding roughly to the ride-through time of PLC's. This requires power supplies with high current reserves and large output capacitors. Furthermore, the impedance of the faulty branch must be sufficiently small in order for the current to actually flow. The best current reserve in the power supply does not help if Ohm's law does not permit current flow. The following table has typical test results showing which B- and C-Characteristic MCBs magnetically trip depending on the wire cross section and wire length.

Fig. 26-5 Test circuit

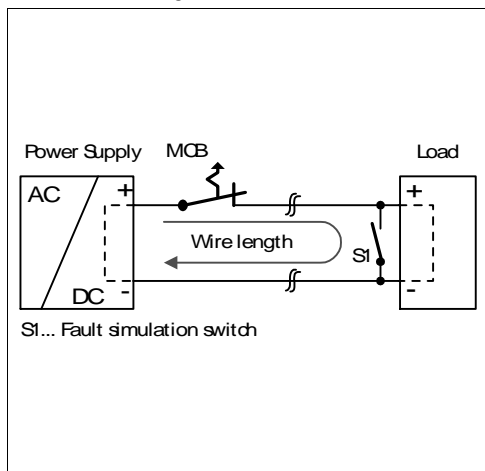

Maximal wire length\*) for a fast (magnetic) tripping:

	0.75mm <sup>2</sup>	1.0mm <sup>2</sup>	1.5mm <sup>2</sup>	2.5mm <sup>2</sup>
<b>C-2A</b>	29m	38m	54m	86m
<b>C-3A</b>	27m	34m	48m	78m
<b>C-4A</b>	19m	26m	38m	58m
<b>C-6A</b>	10m	15m	21m	34m
<b>C-8A</b>	8m	12m	18m	28m
<b>C-10A</b>	7m	11m	16m	26m
<b>C-13A</b>	4m	6m	8m	13m
<b>B-6A</b>	19m	25m	35m	55m
<b>B-10A</b>	11m	17m	24m	40m
<b>B-13A</b>	10m	13m	21m	29m
<b>B-16A</b>	7m	11m	15m	24m
<b>B-20A</b>	5m	7m	9m	16m

\*) Don't forget to consider twice the distance to the load (or cable length) when calculating the total wire length (+ and - wire).

### 26.6. PARALLEL USE TO INCREASE OUTPUT POWER

Power supplies from the same series (Q-Series) can be paralleled to increase the output power. The output voltage shall be adjusted to the same value ( $\pm 100\text{mV}$ ) in "Single use" mode with the same load conditions on all units, or the units can be left with the factory settings. After the adjustments, the jumper on the front of the unit shall be moved from "Single use" to "Parallel use", in order to achieve load sharing. The "Parallel use" mode regulates the output voltage in such a manner that the voltage at no load is approx. 4% higher than at nominal load. See also chapter 6. If no jumper is plugged in, the unit is in "Single use" mode. Factory setting is also "Single use" mode.

If more than three units are connected in parallel, a fuse or circuit breaker with a rating of 50A or 63A is required on each output. Alternatively, a diode or redundancy module can also be utilized.

Energize all units at the same time to avoid the overload Hiccup<sup>PLUS</sup> mode. It also might be necessary to cycle the input power (turn-off for at least five seconds), if the output was in Hiccup<sup>PLUS</sup> mode due to overload or short circuits and the required output current is higher than the current of one unit.

Keep an installation clearance of 15mm (left / right) between two power supplies and avoid installing the power supplies on top of each other. Do not use power supplies in parallel in mounting orientations other than the standard mounting orientation (terminals on the bottom of the unit) or in any other condition where a derating of the output current is required (e.g. altitude, above 60°C, ...).

Pay attention that leakage current, EMI, inrush current, harmonics will increase when using multiple power supplies.

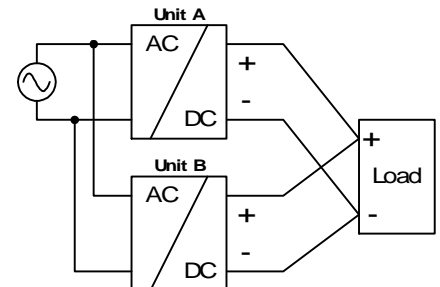

### 26.7. PARALLEL USE FOR REDUNDANCY

Power supplies can be paralleled for redundancy to gain higher system availability. Redundant systems require a certain amount of extra power to support the load in case one power supply unit fails. The simplest way is to put two power supplies in parallel. This is called a 1+1 redundancy. In case one power supply unit fails, the other one is automatically able to support the load current without any interruption. Redundant systems for a higher power demand are usually built in a N+1 method. E.g. five power supplies, each rated for 40A are paralleled to build a 160A redundant system. For N+1 redundancy the same restrictions apply as for increasing the output power, see also chapter 26.6.

**Please note:** This simple way to build a redundant system does not cover failures such as an internal short circuit in the secondary side of the power supply. In such a case, the defective unit becomes a load for the other power supplies and the output voltage can not be maintained any more. This can be avoided by utilizing redundancy modules, which have decoupling devices (diodes or mosfets) included. Further information and wiring configurations can be found in chapter 25.3 and 25.4.

Recommendations for building redundant power systems:

- Use separate input fuses for each power supply. A separate source for each supply when possible increases the reliability of the redundant system.
- Set the power supply into "Parallel Use" mode.
- Monitor the individual power supply units. Therefore, use the DC-OK relay contact of the QS40 power supply.
- It is desirable to set the output voltages of all units to the same value ( $\pm 100\text{mV}$ ) or leave it at the factory setting.

### 26.8. SERIES OPERATION

Power supplies of the same type can be connected in series for higher output voltages. It is possible to connect as many units in series as needed, providing the sum of the output voltage does not exceed 150Vdc. Voltages with a potential above 60Vdc are not SELV anymore and can be dangerous. Such voltages must be installed with a protection against touching.

Earthing of the output is required when the sum of the output voltage is above 60Vdc. Avoid return voltage (e.g. from a decelerating motor or battery) which is applied to the output terminals.

Keep an installation clearance of 15mm (left / right) between two power supplies and avoid installing the power supplies on top of each other. Do not use power supplies in series in mounting orientations other than the standard mounting orientation (terminals on the bottom of the unit).

Pay attention that leakage current, EMI, inrush current, harmonics will increase when using multiple power supplies.

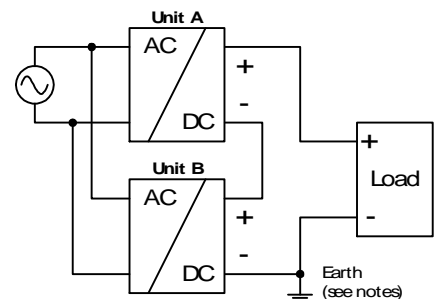

### 26.9. INDUCTIVE AND CAPACITIVE LOADS

The unit is designed to supply any kind of loads, including capacitive and inductive loads. If extreme large capacitors, such as EDLCs (electric double layer capacitors or "UltraCaps") with a capacitance > 2.5F are connected to the output, the unit might charge the capacitor in the Hiccup<sup>PLUS</sup> mode (see chapter 6).

### 26.10. BACK-FEEDING LOADS

Loads such as decelerating motors and inductors can feed voltage back to the power supply. This feature is also called return voltage immunity or resistance against Back- E.M.F. (Electro Magnetic Force).

This power supply is resistant and does not show malfunctioning when a load feeds back voltage to the power supply. It does not matter whether the power supply is on or off.

The maximum allowed feed-back-voltage is 35Vdc. The absorbing energy can be calculated according to the built-in large sized output capacitor which is specified in chapter 6.

### 26.11. OPERATION ON TWO PHASES

The power supply can also be used on two-phases of a three-phase-system. Such a phase to phase connection is allowed as long as the supplying voltage is below  $240V^{+10\%}$ .

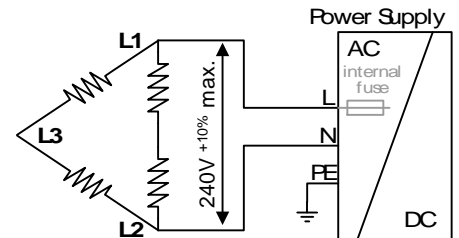

### 26.12. USE IN A TIGHTLY SEALED ENCLOSURE

When the power supply is installed in a tightly sealed enclosure, the temperature inside the enclosure will be higher than outside. In such situations, the inside temperature defines the ambient temperature for the power supply.

The following measurement results can be used as a reference to estimate the temperature rise inside the enclosure.

The power supply is placed in the middle of the box, no other heat producing items are inside the box

Enclosure:	Rittal Typ IP66 Box PK 9522 100, plastic, 254x180x165mm
Load:	24V, 32A; (=80%) load is placed outside the box
Input:	230Vac
Temperature inside enclosure:	68.6°C (in the middle of the right side of the power supply with a distance of 2cm)
Temperature outside enclosure:	24.3°C
Temperature rise:	44.3K

### 26.13. MOUNTING ORIENTATIONS

Mounting orientations other than all terminals on the bottom require a reduction in continuous output power or a limitation in the maximum allowed ambient temperature. The amount of reduction influences the lifetime expectancy of the power supply. Therefore, two different derating curves for continuous operation can be found below:

**Curve A1** Recommended output current.

**Curve A2** Max. allowed output current (results in approximately half the lifetime expectancy of A1).

Fig. 26-6  
**Mounting Orientation A**  
(Standard orientation)

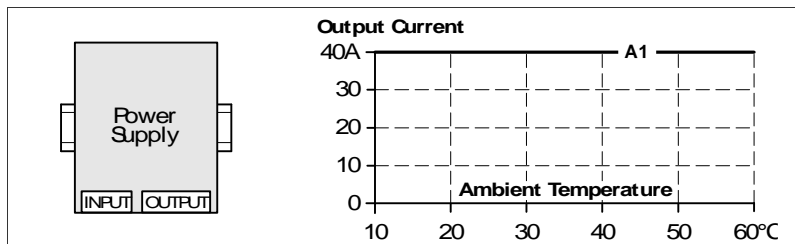

Fig. 26-7  
**Mounting Orientation B**  
(Upside down)

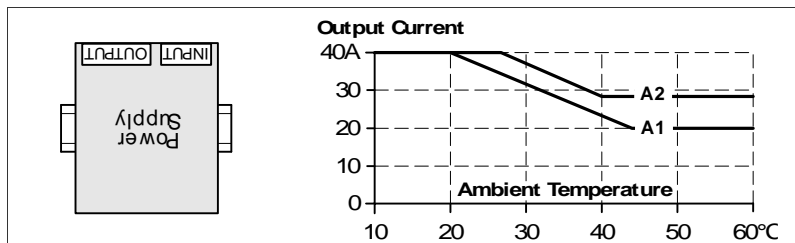

Fig. 26-8  
**Mounting Orientation C**  
(Table-top mounting)

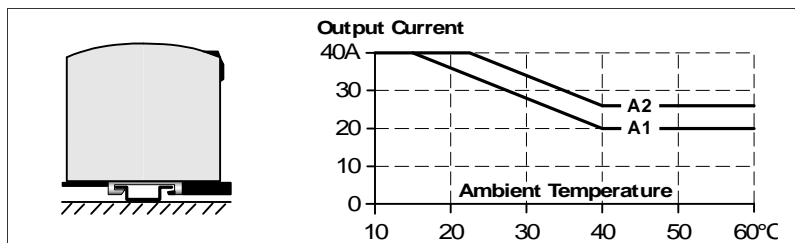

Fig. 26-9  
**Mounting Orientation D**  
(Horizontal cw)

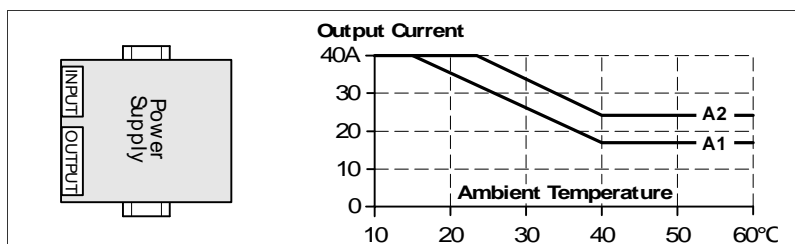

Fig. 26-10  
**Mounting Orientation E**  
(Horizontal ccw)

