



Read this first!

English

Before operating this device, please read this manual thoroughly and retain this manual for future reference! This device may only be installed and put into operation by qualified personnel. If damage or malfunction should occur during operation, immediately turn power off and send device to the factory for inspection. The device does not contain serviceable parts. The information presented in this document is believed to be accurate and reliable and may change without notice. For any clarifications the English translation will be used.

⚠ WARNING Risk of electrical shock, fire, personal injury, or death:

- Turn power off before working on the device. Protect against inadvertent re-powering.
- Do not open, modify or repair the device.
- Use caution to prevent any foreign objects from entering the housing.
- Do not use in wet locations or in areas where moisture or condensation can be expected.
- Do not touch during power-on and immediately after power-off. Hot surfaces may cause burns.

Vor Inbetriebnahme lesen!

Deutsch

Bitte lesen Sie diese Warnungen und Hinweise sorgfältig durch, bevor Sie das Gerät in Betrieb nehmen. Bewahren Sie die Anleitung zum Nachlesen auf. Das Gerät darf nur durch fachkundiges und qualifiziertes Personal installiert werden. Bei Funktionsstörungen oder Beschädigungen schalten Sie sofort die Versorgungsspannung ab und senden das Gerät zur Überprüfung ins Werk. Das Gerät beinhaltet keine Servicebauteile. Die angegebenen Daten dienen allein der Produktbeschreibung und sind nicht als zugesicherte Eigenschaften im Rechtssinne aufzufassen. Im Zweifelsfall gilt der englische Text.

⚠ WARNUNG Missachtung nachfolgender Punkte kann einen elektrischen Schlag, Brände, schwere Unfälle oder Tod zur Folge haben:

- Schalten Sie die Eingangsspannung vor Installations-, Wartungs- oder Änderungsarbeiten ab und sichern Sie diese gegen unbeabsichtigtes Wiedereinschalten.
- Führen Sie keine Änderungen oder Reparaturversuche am Gerät durch. Gerät nicht öffnen!
- Verhindern Sie das Eindringen von Fremdkörpern, wie z.B. Büroklammern und Metallteilen.
- Betreiben Sie das Gerät nicht in feuchter Umgebung oder in einer Umgebung, bei der mit Betauung oder Kondensation zu rechnen ist.
- Gehäuse nicht während des Betriebes oder kurz nach dem Abschalten berühren. Heiße Oberflächen können Verletzungen verursachen.

A lire avant mise sous tension!

Français

Veuillez lire ces instructions de montage et d'entretien avant de mettre l'alimentation sous tension. Conservez ce manuel qui vous sera toujours utile. Cette alimentation ne doit être installée que par du personnel qualifié et compétent. En cas de dommage ou dysfonctionnement, coupez immédiatement la tension d'alimentation et retournez l'appareil à l'usine pour vérification. ! L'alimentation ne contient pas de pièces échangeables Les données indiquées dans ce document servent uniquement à donner une description du produit et n'ont aucune valeur juridique. En cas de divergences, le texte anglais fait foi.

⚠ AVERTISSEMENT Prendre en compte les points suivants, afin d'éviter toute détérioration électrique, incendie, dommage aux personnes ou mort:

- Mettre l'alimentation hors tension avant toute intervention sur celle-ci et s'assurer qu'il n'y a pas risque de redémarrage.
- Ne pas ouvrir, modifier ou réparer l'alimentation.
- Veiller à ce qu'aucun objet ne rentre en contact avec l'intérieur de l'alimentation (trombones, pièces métalliques).
- Ne pas faire fonctionner l'appareil dans un environnement humide ou dans un environnement où il peut y avoir de la condensation.
- Ne pas toucher le carter pendant le fonctionnement ou directement après la mise hors tension. Surface chaude risquant d'entraîner des blessures.

Lea primero!

Español

Conservare este manual como referencia para futuras consultas. La fuente de alimentación solo puede ser instalada y puesta en funcionamiento por personal cualificado. Por favor lea detenidamente este manual antes de conectar la fuente de alimentación. Si se produce un fallo o mal funcionamiento durante la operación, desconecte inmediatamente la tensión de alimentación. En ambos casos, el equipo debe ser inspeccionado en fábrica. La información presentada en este documento es exacta y fiable en cuanto a la descripción del producto y puede cambiar sin aviso. En casa de duda, prevalece el texto inglés.

⚠ ADVERTENCIA Riesgo de descarga eléctrica, incendio, accidente grave o muerte:

- Desconectar la tensión de red antes de trabajar en la fuente de alimentación. Evite una posible reconexión involuntaria.
- No realizar ninguna modificación o reparación de la unidad. No abrir la unidad.
- Evitar la introducción en la carcasa de objetos extraños.
- No usar el equipo en ambientes húmedos. No operar el equipo en ambientes donde se espere la formación de rocío o condensación.
- No tocar durante el funcionamiento ni inmediatamente después del apagado. El calor de la superficie puede causar quemaduras graves.

Leggere prima questa parte!

Italiano

Prima di collegare il sistema di alimentazione elettrica si prega di leggere attentamente le seguenti avvertenze. Conservare le istruzioni per la consultazione futura. Il sistema di alimentazione elettrica deve essere installato solo da personale competente e qualificato. Se durante il funzionamento si verificano anomalie o guasti, scollegare immediatamente la tensione di alimentazione. In entrambi i casi è necessario far controllare l'apparecchio dal produttore! I dati sono indicati solo a scopo descrittivo del prodotto e non vanno considerati come caratteristiche garantite dell'apparecchio. In caso di differenze o problemi è valido il testo inglese

⚠ AVVERTENZA Il mancato rispetto delle seguenti norme può provocare folgorazione elettrica, incendi, gravi incidenti e perfino la morte:

- Prima di eseguire interventi di installazione, di manutenzione o di modifica scollegare la tensione di rete ed adottare tutti i provvedimenti necessari per impedire il ricollegamento non intenzionale.
- Non tentare di aprire, di modificare o di riparare da soli l'apparecchio.
- Impedire la penetrazione di corpi estranei nell'apparecchio, ad esempio fermagli o altri oggetti metallici.
- Non far funzionare l'apparecchio in un ambiente umido. Non far funzionare l'apparecchio in un ambiente soggetto alla formazione di condensa o di rugiada.
- Non toccare quando acceso e subito dopo lo spegnimento. La superficie calda può causare scottature.

Leia primeiro!

Português

Recomendamos a leitura cuidadosa das seguintes advertências e observações, antes de colocar em funcionamento a fonte de alimentação. Guarde as Instruções para futura consulta, em casos de dúvida. A fonte de alimentação deverá ser instalada apenas por profissionais da área, tecnicamente qualificados. Se por acaso, durante a utilização ocorrer algum defeito de funcionamento ou dano, desligue imediatamente a tensão de alimentação. Em ambos os casos, será necessária uma verificação na Fábrica! Os dados mencionados têm como finalidade somente a descrição do produto, e não devem ser interpretados como propriedades garantidas no sentido jurídico. Em caso de dúvidas aplica-se o texto em inglês.

⚠ ATENÇÃO A não observância ou o incumprimento dos pontos a seguir mencionados, poderá causar uma descarga elétrica, incêndios, acidentes graves ou morte:

- Antes de trabalhos de instalação, manutenção ou modificação, desligue a tensão de alimentação, protegendo-a contra uma nova ligação involuntária.
- Não efectue nenhuma modificação ou tentativa de reparação no aparelho. Quando necessário contacte o seu distribuidor. Não abra o aparelho.
- Proteger a fonte de alimentação contra a introdução inadvertida de corpos metálicos, como por ex., cliques ou outras peças de metal.
- Não usar o aparelho em ambientes húmidos. Não usar o aparelho em ambientes propensos a condensações.
- Não tocar enquanto estiver em funcionamento, nem após a desligar. A superfície poderá estar quente e provocar lesões.

Product Description

The PISA-B-812-B4 is a DIN-rail mountable eight channel protection module with integrated electronic fuses for 24V systems.

Intended Use

This device is designed for installation in an enclosure and is intended for commercial use, such as in industrial control, process control, monitoring and measurement equipment or the like.

The device is suitable for indoor applications. Outdoor applications are also allowed as long as all requirements specified in this manual (enclosure, controlled environment, condensation, ...) are met.

Do not use this device in equipment, where malfunctioning may cause severe personal injury or threaten human life without additional appropriate safety devices, that are suited for the end-application.

If this device is used in a manner outside of its specification, the protection provided by the device may be impaired.

Installation Instructions

Install the device in an enclosure providing protection against electrical, mechanical and fire hazards.

Install the device onto a DIN-rail according to EN 60715 with the input terminals on top of the unit.

Up to eight devices can be connected via two bus bars, where only the first device is connected to the power supply. The bus bars must be long enough to make a connection to all contacts of the devices.

Use an appropriately sized 24V power supply, which can deliver the peak current required to trip the load channels. If peak currents are too low, the supply voltage for the protection module can no longer be maintained, which results in a malfunctioning of the protection module.

Make sure that the wiring is correct by following all local and national codes. Use appropriate copper cables that are designed for a minimum operating temperature of 60°C for ambient temperatures up to +45°C, 75°C for ambient temperatures up to +60°C and 90°C for ambient temperatures up to +70°C. Ensure that all strands of a stranded wire enter the terminal connection.

The device is designed for pollution degree 2 areas in controlled environments. No condensation or frost is allowed.

The enclosure of the device provides a degree of ingress protection of IP20. The housing does not provide protection against spilled liquids.

The isolation of the devices is designed to withstand impulse voltages up to 1.5kV according to IEC 60664-1.

The input can be powered from a regulated power supply or a similar DC source.

The input must be powered from a PELV or SELV source in order to maintain a SELV or PELV output. Check for correct input polarity. The device will not operate when the voltage is reversed.

A disconnecting means shall be provided for the input of the device.

The device is designed as "Class of Protection III" equipment according to IEC 61140.

The device is designed for convection cooling and does not require an external fan. Do not obstruct airflow and do not cover ventilation grid!

Keep the following minimum installation clearances: 40mm on top, 20mm on the bottom, 5mm left and right side. Increase the 5mm to 15mm in case the adjacent device is a heat source. Between multiple PISA-B modules, no clearance is needed.

The device is designed for altitudes up to 5000m (16 400ft).

The maximum surrounding air temperature is +70°C (+158°F). The operational temperature is the same as the ambient or surrounding air temperature and is defined 2cm below the device.

The device is designed to operate in areas between 5% and 95% relative humidity.

Functional Description

The output can supply any kind of loads, including inductive and capacitive loads. The maximum size of capacitive loads is specified in the "Technical Data" table. Larger load capacitors might result in an unintended turn-off of the channel.

Do not load the individual channels with higher average currents depending on the ambient temperature, as specified in the derating table of this document.

Do not apply return voltages from the load to the output terminals higher than 30V.

Do not parallel outputs for higher output currents.

Do not connect outputs in a series connection for higher output voltages.

Do not connect batteries for charging purposes to the output of the device.

Output channels can be switched on and off separately by pushing the corresponding control button for longer than 50ms. A switched off channel is displayed with the uppermost red LED of the LED bar graph.

If the sum output currents is larger than 40A the unit turns off the output channels one after another until the sum current is below 40A.

The tripping current can be set individually for all channels.

The tripping characteristic can be set as a common parameter for all channels.

Tripping currents and characteristic setting can be protected against changes with a PIN code. To lock the settings push the SET and channel control button 1 until the unit shows a moving text "PIN TO LOCK". Enter a 4-digit PIN by pushing any combination of channel control buttons 1-8. Push the SET button to save the PIN, the unit shows a moving text "LOCKED".

To unlock settings push the SET and channel control button 1, the unit shows a moving text "PIN TO UNLOCK" and enter the 4-digit PIN you selected and confirm it by pushing the SET button.

The device is equipped with a "Digital Coded Alarm Signal" output (pins 13 and 14), which provides information about individual channel tripping. The signal is an opto-coupler-type output which is low ohmic for start bit and for tripped channels. The maximal signal current between pins 13 and 14 is 10mA and the maximal voltage is 35V.

The signal sequence starts with 200ms start bit followed by a 100ms gap and 100ms signal related to CH1 etc. The whole sequence is periodically repeated every 1900ms.

Technical Data

All values are typical figures specified at 24Vdc input voltage, 8x 5A output currents, 25°C ambient temperature and after a 5 minutes run-in time unless otherwise noted.

Input voltage	DC 24V	-20%/+25%
Required input voltage for turning-on of outputs	19.6Vdc	
Input current	40A	
Internal consumption	35mA	
Nominal output current		Adjustable
	1/2/3/4/6/8/10/12A	For CH1 and CH2
	1/2/3/4/6/8/10A	For CH3-CH8
Sum current all channels	40A	Below +60°C ambient
	30A	At +70°C ambient
	Derate linearly between +60°C and +70°C	
Current limitation		
CH1-CH2	200%	For 1A setting
	150%	For 2 - 8A settings
	130%	For 10 - 12A settings
CH3-CH8	50A	
Tripping characteristics	Slow or fast	Selectable
Tripping delay		
CH1-CH2	2ms – 2s	At short circuit
CH3-CH8	<10ms	At short circuit
CH1-CH8	1.1s	For slow tripping setting at 1.5x nominal current
CH1-CH8	0.22s	For fast tripping setting at 1.5x nominal current
Max load capacitance capability		
CH1-CH2	100mF	Per channel
CH3-CH8	20mF	Per channel
Voltage drop per channel		
CH1-CH2	125mV	For 10A load
CH3-CH8	165mV	For 10A load
Standby losses	1W	
Power losses	10.8W	At 8x 5A load current
Temperature range	-25°C to 70°C	
Max. wire size (litz wire)	16mm ²	For input terminals
Max. wire size with ferrules	10mm ²	For input terminals
Wire size AWG	AWG 20-4	For input terminals
Maximum wire diameter	6.1mm	For input terminals
Wire stripping length	19mm / 0.75inch	For input terminals
Max. wire size (litz wire)	2.5mm ²	For output terminals
Max. wire size with ferrules	1.5mm ²	For output terminals
Wire size AWG	AWG 24-12	For output terminals
Maximum wire diameter	2.3mm	For output terminals
Wire stripping length	10mm / 0.4inch	For output terminals
Max. wire size (litz wire)	2.5mm ²	For signal terminals
Max. wire size with ferrules	1.5mm ²	For signal terminals
Wire size AWG	AWG 24-12	For signal terminals
Maximum wire diameter	2.3mm	For signal terminals
Wire stripping length	10mm / 0.4inch	For signal terminals
Size (w x h x d)	52x124x130mm	Without DIN-rail
Weight	370g/0.82lb	

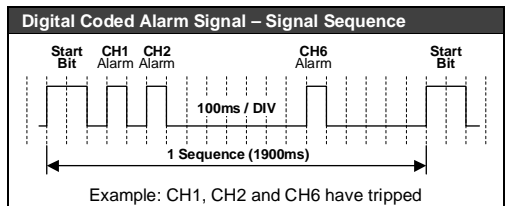
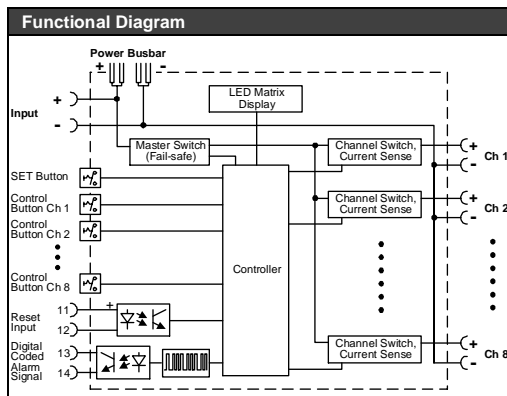

The LED matrix display shows information about measurement, set parameters and errors and contains two modes. To switch between the two modes, the measurement mode and the parameter mode, push the SET button and the channel control button 4.

Measurement Mode

The “%” scale on the left side of the LED Matrix is used in this mode, which is also indicated by the triangular LED below the LED matrix display. In this mode the actual current values are shown and the LED matrix display also shows, if a channel has switched off due to a too high current or on purpose.

- **One or more green/yellow LEDs are on:** These LEDs indicate the actual channel current in percent of the set value. Peak values are stored in a peak detector and are additionally shown with one LED for a short period of time.
- **Uppermost LED is red:** This indicates a switched off channel. To switch the channel back on, the corresponding channel control button must be pressed for at least 50ms. A further push switches the channel off again.
- **Uppermost LED is single flashing in red (2Hz):** This indicates that a channel has switched off due to too high current. A restart can be done either by a button on the unit or by a control signal. Therefore, push the corresponding channel control button for longer than 1s or apply a voltage between 10 and 30Vdc (max. 6mA current consumption) for longer than 1s to the reset input. The reset input is galvanically isolated from the rest of the device.
- **Uppermost LED is double flashing in red:** This indicates that a channel has switched off because the total current of the module exceeds 40A. In such cases, first the overloaded channels are switched off, then channels 8 to 1 in descending order.
- **Display of the settings for tripping currents and tripping characteristic:** Push the SET button for more than 50ms. First the tripping currents are displayed, followed by the tripping characteristic with the letter “F” or “S”. This function ends automatically after 5s.

Parameter Mode

The “A” scale on the right side of the LED Matrix is used in this mode, which is also indicated by the triangular LED below the LED matrix display. In this mode the set values for the tripping currents for each individual channel are displayed and the LED matrix display also shows if a channel has switched off due to a too high current or on purpose.

- **Displaying of the set current:** The green LED shows the set current of the individual channel.
- **Displaying of the tripping characteristic:** Push the SET button. The selected characteristic is shown on the LED matrix for 2 seconds. Letter F indicates the fast and the letter S the slow acting characteristic. The setting applies to all output channels.
- **Red LEDs:** These indicate a switched off or overloaded channel and include the same LED blinking pattern and push-button behaviour as in the measurement mode. If a channel is set to 12A, the LED below the uppermost LED will display this switched-off information.

Changing of Trip Currents and Trip Characteristic

Factory settings are that all channels are turned on with a 1A setting in a fast tripping characteristic and in measurement mode. Parameters can be changed in the measuring mode as well as in the parameter mode. Parameters can be changed regardless of whether a channel is switched off or not.

- **Changing the current settings:** Press and hold the SET button for at least 1s. The triangular green “A” LED starts flashing. After that, shortly tap the channel control button multiple times to adjust the current step by step. When the desired setting is found, press the SET buttons for more than 50ms to save the setting. This mode ends automatically 10 seconds after no more buttons are pushed. In case the settings are not saved by pressing the SET button, changes of tripping currents are not stored.
- **Changing of the tripping characteristic (slow or fast):** To change the characteristic for all channels push the SET and the channel control button 3 at the same time. The selected characteristic is shown on the LED matrix for 2 seconds and stored automatically. Letter “F” indicates the fast and “S” the slow acting characteristic.

Key Combination Overview

- SET + CCB1 button = lock/unlock setting with PIN
- SET + CCB2 button = show FW versions
- SET + CCB3 button = fast/slow tripping characteristic
- SET + CCB4 button = measurement/parameter mode

Front Side and User Elements

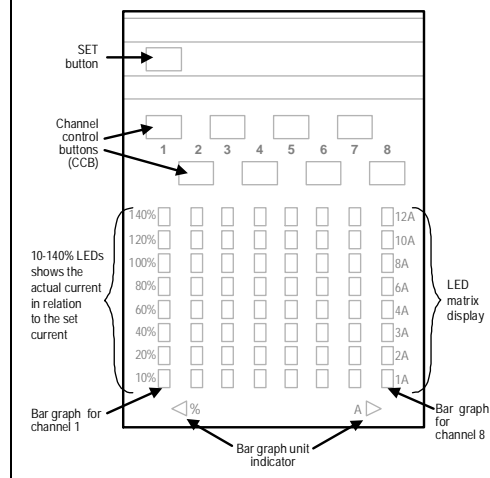

Wiring Scheme

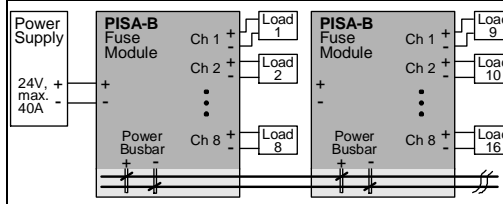

LED Light Pattern in Measurement Mode

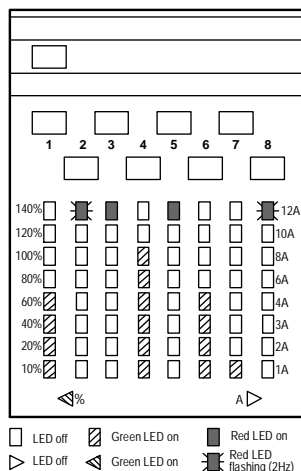

Description:

- Channel 1** is loaded with 40-60% of the set current
- Channel 2** has tripped due to over current – no output
- Channel 3** is turned off on purpose (with push-button)
- Channel 4** is loaded with 80-100% of the set current
- Channel 5** is turned off on purpose (with push-button)
- Channel 6** is loaded with 40-60% of the nominal current
- Channel 7** is loaded with 0-10% of the nominal current
- Channel 8** has tripped due to over current – no output

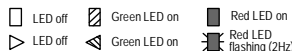

LED Light Pattern in Parameter Mode

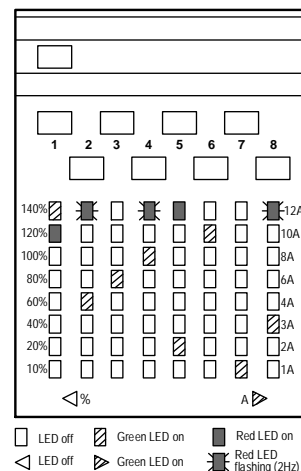

Description:

- Channel 1** is set to 12A and output is turned off on purpose (with push-button)
- Channel 2** is set to 4A and output has tripped due to over current
- Channel 3** is set to 6A and output is on
- Channel 4** is set to 8A and output has tripped due to over current
- Channel 5** is set to 2A and output is turned off on purpose (with push-button)
- Channel 6** is set to 10A and output is on
- Channel 7** is set to 1A and output is on
- Channel 8** is set to 3A and output has tripped due to over current

Maximal Average Output Current per Channel Depending on the Ambient Temperature (Derating Table) - Examples

Ambient Temperature	Sum of all channel currents	CH1	CH2	CH3	CH4	CH5	CH5	CH7	CH8
-25°C to +40°C	max. 40A	12A	12A	10A	10A	10A	10A	10A	10A
+41°C to +50°C	max. 40A	10A	10A	10A	10A	8A	8A	8A	8A
+51°C to +55°C	max. 40A	12A	12A	8A	8A	8A	8A	8A	8A
+51°C to +55°C	max. 40A	10A	10A	2A	10A	2A	10A	2A	2A
+56°C to +60°C	max. 40A	8A	8A	8A	8A	8A	8A	8A	8A
+56°C to +60°C	max. 40A	12A	12A	6A	6A	6A	6A	6A	6A
+61°C to +70°C	max. 30A	12A	12A	6A	6A	6A	6A	6A	6A

Tripping Diagrams

The following curves show the let-through current areas, which are located to the left of the curves, and the tripping areas, which are located to the right of the curves.

