

POWER SUPPLY 380-480 Vac 48 V 500 W

- IP54 degree of protection
- 1000 W_{peak} 5 s
- 3AC 380-480 V wide-range input
- Output connected to PE (PELV/ES1)
- 96.6 % full load and excellent partial load efficiencies
- Full power between -30 °C and +55 °C
- Negligibly low input inrush current surge
- High immunity to transients and power surges
- Low electromagnetic emissions
- Large output capacitors
- DC-OK relay contact
- Integrated braking resistor board
- 3 year warranty

PRODUCT DESCRIPTION

The FPT500 is an industrial grade power supply for a 3-phase mains system that is incorporated into a rugged wall-mount housing with an IP54 degree of protection.

It provides 1 stabilised output that is galvanically insulated from the input. The negative terminal of the output is permanently connected to PE within the unit.

The most outstanding features of the FPT series are compact size, wide operating temperature range, extremely low input inrush current and very high efficiencies, which are achieved through various design topologies. The large output capacitors can absorb and store regenerative energy from braking motors.

High immunity to transients and power surges as well as low electromagnetic emissions and an international approval package make the use in nearly every application possible.

SHORT-FORM DATA

| | | |
|-------------------|--|----------------------|
| Output voltage | DC 48 V | nominal |
| Adjustment range | 48-56 V | factory setting 48 V |
| Output power | 500 W | up to +55 °C ambient |
| | 350 W | up to +70 °C ambient |
| BonusPower | 600 W | up to +45 °C ambient |
| Short term (5 s) | 1000 W | up to +55 °C ambient |
| | 700 W | up to +70 °C ambient |
| | Derate linearly between +45 °C to +70 °C | |
| Input voltage AC | 3AC 380-480 V | ±15 % |
| Power factor | 0.94 / 0.95 | at 3x 400 / 480 Vac |
| AC Inrush current | 1.9 / 1.8 A _{peak} | at 3x 400 / 480 Vac |
| Efficiency | 96.6 / 96.3 % | at 3x 400 / 480 Vac |
| Power Losses | 17.3 / 18.7 W | at 3x 400 / 480 Vac |
| Hold-up time | 24 / 24 ms | at 3x 400 / 480 Vac |
| Temperature range | -30 °C to +70 °C | |
| Size (wxhxd) | 181x272x70 mm without connectors | |
| Weight | 1550 g | |

ORDER NUMBERS

FPT500.481-008-103 Power supply
Input Han Q 4/2
Output ASi cable

Complementary units:
ZM.FPDRA-11 DIN rail mounting kit
ZM.FPMBA-11 Mounting bracket

MAIN APPROVALS

For details and a complete approval list, see chapter 19.

CB Report 

IEC 62368-1
IEC 61010-2-201

UL 61010

Index

| | | | | | |
|----|-------------------------------------|----|------|--|----|
| 1 | Intended Use..... | 4 | 18 | Dielectric Strength..... | 20 |
| 2 | Installation Instructions..... | 4 | 19 | Approved, Fulfilled or Tested Standards..... | 21 |
| 3 | AC Input..... | 5 | 20 | Regulatory Product Compliance..... | 21 |
| 4 | DC Input..... | 6 | 21 | Accessories..... | 22 |
| 5 | Input Inrush Current..... | 6 | 21.1 | DIN Rail Mounting Kit: ZM.FPDRA-11..... | 22 |
| 6 | Output..... | 7 | 21.2 | Mounting Bracket: ZM.FPMBA-11..... | 22 |
| 7 | Hold-up Time..... | 8 | 22 | Application Notes..... | 23 |
| 8 | DC-OK Relay Contact..... | 9 | 22.1 | Repetitive Pulse Loading..... | 23 |
| 9 | Efficiency and Power Losses..... | 10 | 22.2 | External Input Protection..... | 23 |
| 10 | Lifetime Expectancy..... | 11 | 22.3 | Inductive and Capacitive Loads..... | 23 |
| 11 | MTBF..... | 11 | 22.4 | Two Phases Operation..... | 23 |
| 12 | Functional Diagram..... | 12 | 22.5 | Back-Feeding Loads..... | 24 |
| 13 | Dimensions and Connectors..... | 13 | 22.6 | Parallel Use to Increase Output Power..... | 24 |
| 14 | User Interface..... | 14 | 22.7 | Series Operation..... | 24 |
| 15 | EMC..... | 16 | 22.8 | Mounting Orientations..... | 25 |
| 16 | Environment..... | 18 | | | |
| 17 | Safety and Protection Features..... | 19 | | | |

The information given in this document is correct to the best of our knowledge and experience at the time of publication. If not expressly agreed otherwise, this information does not represent a warranty in the legal sense of the word. As the state of our knowledge and experience is constantly changing, the information in this data sheet is subject to revision. We therefore kindly ask you to always use the latest issue of this document (available under www.pulspower.com).

No part of this document may be reproduced or utilised in any form without our prior permission in writing.

Packaging and packaging aids can and should always be recycled. The product itself may not be disposed of as domestic refuse.

Terminology and Abbreviation

| | |
|--|---|
| PE and \oplus Symbol | PE is the abbreviation for Protective Earth and has the same meaning as the symbol \oplus . |
| FE, Earth, Ground (GND) | This document uses the term "earth" which is the same as the U.S. term "ground". |
| t.b.d. | To be defined, value or description will follow later. |
| 3AC 400 V | A figure displayed with the AC or DC before the value represents a nominal voltage with standard tolerances (usually $\pm 15\%$) included. E.g.: DC 12 V describes a 12 V battery disregarding whether it is full (13.7 V) or flat (10 V) |
| 3x 400 Vac | A figure with the unit (Vac) at the end is a momentary figure without any additional tolerances included. |
| 50 Hz vs. 60 Hz | As long as not otherwise stated, 3AC 400 V parameters are valid at 50 Hz mains frequency. |
| may | A key word indicating flexibility of choice with no implied preference. |
| shall | A key word indicating a mandatory requirement. |
| should | A key word indicating flexibility of choice with a strongly preferred implementation. |

Nomenclature

| Detail | Description |
|-----------|---|
| FPT | 380-480 V 3-phase power supply |
| FPS | 100-240 V 1-phase power supply |
| FPH | 200-240 V 1-phase power supply |
| 300 | 300 W power class |
| 500 | 500 W power class |
| 241 / 481 | Standard power supply with output voltage 24 - 28 V / 48 - 52 V setting and LED bar |
| 242 / 482 | Basic power supply without voltage setting and LED bar. This version has status LEDs. |
| 245 / 485 | Power supply with up to 4 eFuse channels |
| 246 / 486 | Power supply with up to 4 NEC Class 2 channels |
| 247 / 487 | Power supply with NEC Class 2 and eFuse channel |
| 0xx | Terminal configuration e.g. .002. Input: Han Q 4/2 Com: M12-A Output: Han Q 4/0 |
| 1xx | Consecutively numbered |

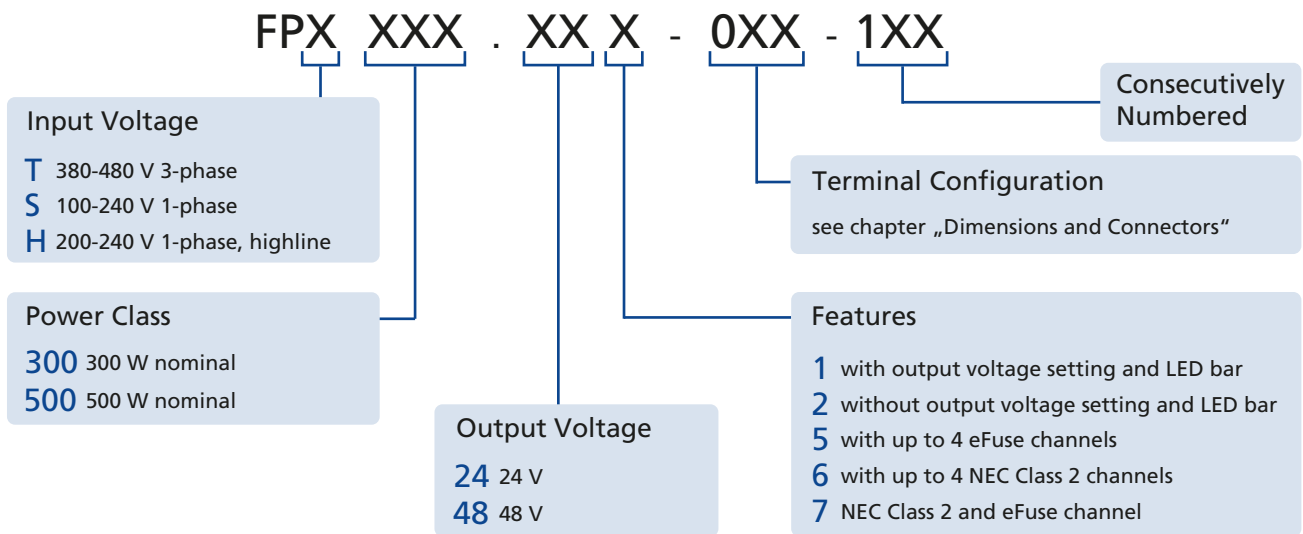

1. Intended Use

This device is designed for indoor use and is intended for commercial use, such as in industrial control, process control, monitoring and measurement equipment.

Do not use this device in equipment where malfunction may cause severe personal injury or threaten human life. If this device is used in a manner outside of its specification, the protection provided by the device may be impaired.

2. Installation Instructions

⚠ DANGER Risk of electrical shock, fire, personal injury or death

- Turn power off before working on the device. Protect against inadvertent re-powering.
- Do not open, modify or repair the device.
- Do not open the unit as high voltages are present inside.
- Do not touch during power-on and immediately after power-off. Hot surfaces may cause burns.
- Install the device on a large enough flat surface. Sharp edges on the back may cause injury.
- If damage or malfunction occur during installation or operation, immediately turn power off and send unit to the factory for inspection.
- The device is designed as “Class of Protection I” equipment according to IEC 61140. Do not use without a proper PE (Protective Earth) connection.

⚠ WARNING Risk of damages to the device

- Keep the following minimum installation clearances: 50 mm on top and 10 mm on the left and right side.
- The maximum surrounding air temperature is +70 °C. The operational temperature is the same as the ambient or surrounding air temperature and is defined 3 cm below the device.
- The device is designed to operate in areas between 5 % and 95 % relative humidity.
- Clean only with a damp cloth.

Obey the following installation instructions:

This device may only be installed and put into operation by qualified personnel. This device does not contain serviceable parts. The tripping of an internal input fuse is caused by an internal defect. Install the device onto a flat surface with the terminals on the bottom of the device. Other mounting orientations require a reduction in output power, see chapter 22.8.

For wall mounting use 4 screws. Two on top and 2 on bottom mounting holes. Recommended screw size is M4 (UNC 8-32). The enclosure of the device provides a degree of protection of IP54 when installed with all mating connectors firmly connected. The device is designed for pollution degree 3 areas in controlled environments.

Assure that during installation no moisture or dirt gets into the connections. Operation in areas where moisture or condensation can be expected is possible.

The negative potential of the outputs is permanently connected to PE within the unit. Do not connect the negative potential of any output to PE outside the unit.

For TN-, TT-mains systems with earthed neutral and IT star mains systems with insulation monitoring the device is designed for overvoltage category III zones up to 2000 m and for overvoltage category II zones up to 5000 m.

For TN-, TT-, IT-delta mains systems or IT star mains systems without insulation monitoring the device is intended for overvoltage category II zones up to 2000 m.

The device is designed for altitudes up to 5000 m. Above 2000 m a reduction in output current is required and the operation is limited according mains systems described above. The device is designed, tested and approved for branch circuits up to 30 A (UL) and 32 A (IEC) without additional protection device. If an external fuse is utilized, do not use circuit breakers smaller than 6 A B- or C-characteristic to avoid an unintentional tripping. A disconnecting means shall be provided for the input of the device. This must be suitably located and easily accessible. The disconnecting means must be marked as such for the device.

3. AC Input

The device is suitable to be supplied from TN-, TT- or IT-mains networks. For more details, see chapter 2. An operation on only two legs of a three-phase system is possible with slightly different parameters, see chapter 22.4.

| | | |
|------------------------------|----------------------------------|----------------------------------|
| AC input voltage rated range | nom. 3AC 380-480 V | ±15 % |
| AC input operating range | 3x 323-552 Vac | |
| Input frequency | nom. 50-60 Hz | ±6 % |
| Turn-on voltage | typ. 3x 320 Vac | steady-state value, see Fig. 3-1 |
| Shut-down voltage | typ. 3x 300 Vac | steady-state value, see Fig. 3-1 |
| External input protection | see recommendations in chapter 2 | |

| | 3AC 400 V | 3AC 480 V | |
|-------------------|--------------|-----------|--|
| Input current | typ. 0.8 A | 0.66 A | at 500 W, symmetrical phase voltages, see Fig. 3-3 |
| Power factor | typ. 0.94 | 0.95 | at 500 W, see Fig. 3-4 |
| Start-up delay | typ. 1000 ms | 1000 ms | at 500 W, symmetrical phase voltages, see Fig. 3-2 |
| Rise time | typ. 30 ms | 30 ms | at 500 W, constant current load, 0 mF, see Fig. 3-2 |
| | typ. 60 ms | 60 ms | at 500 W, constant current load, 12.5 mF, see Fig. 3-2 |
| Turn-on overshoot | max. 500 mV | 500 mV | see Fig. 3-2 |

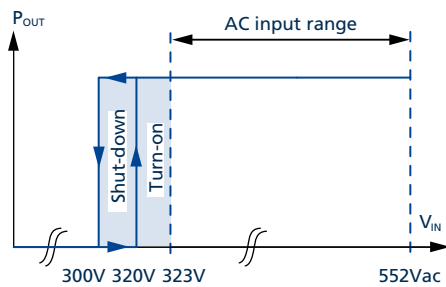

Fig. 3-1: Input voltage range

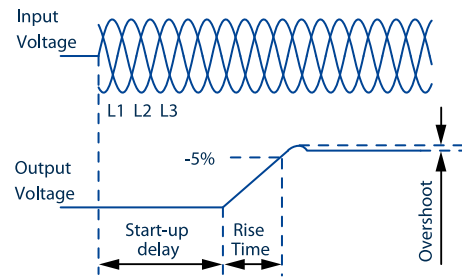

Fig. 3-2: Turn-on behaviour, definitions

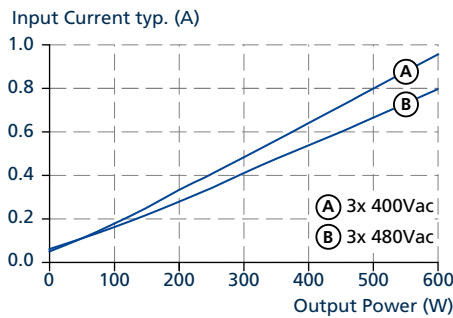

Fig. 3-3: Input current vs. output power at 48 V output voltage

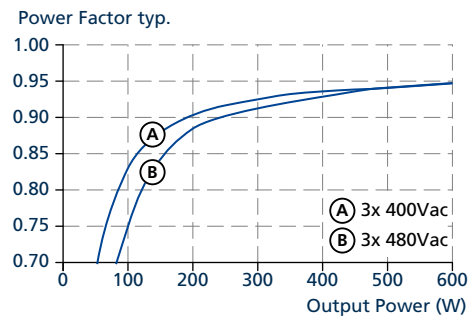

Fig. 3-4: Power factor vs. output power at 48 V output voltage

4. DC Input

Do not operate this power supply with DC input voltage.

5. Input Inrush Current

The power supply is equipped with an active inrush current limitation circuit, which limits the input inrush current after turn-on to an extremely low value. The inrush current is usually smaller than the steady-state input current.

| | | 3AC 400 V | 3AC 480 V | |
|------------------------------|------|-----------------------|-----------------------|-------------------------|
| Inrush current ¹⁾ | max. | 2.1 A _{peak} | 2 A _{peak} | temperature independent |
| | typ. | 1.9 A _{peak} | 1.8 A _{peak} | temperature independent |

¹⁾ The charging current into EMI suppression capacitors is disregarded in the first microseconds after switch-on.

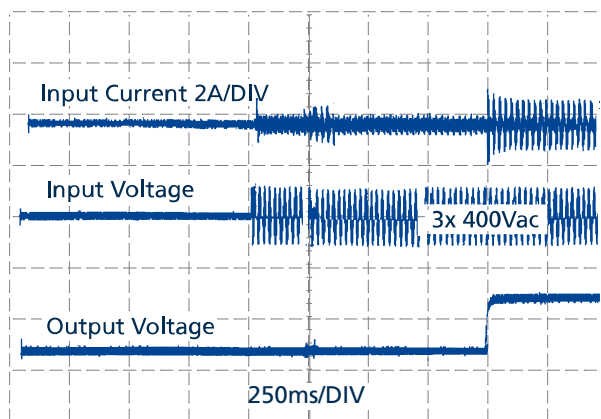

Fig. 5-1: Typical turn-on behavior at nominal load and +25 °C ambient temperature

6. Output

The output provides a (PELV/ES1) rated voltage, which is galvanically isolated from the input voltage. The negative potential of the outputs is permanently connected to PE within the unit. Do not connect any output to PE (Ground).

The device is designed to supply any kind of loads, including capacitive and inductive loads. If capacitors with a capacitance > 100 mF are connected to the output, the unit might charge the capacitor in overcurrent mode.

| | | | |
|----------------------------------|------|------------|---|
| Number of outputs | | 1 | |
| Output voltage | nom. | 48 V | |
| Adjustment range | | 48-56 V | adjustable in steps: 48 V, 49 V, 50 V, 51 V, 52 V, 53 V, 54 V and 56 V |
| Factory settings | typ. | 48 V | ±0.2 %, at nominal load |
| Line regulation | max. | 10 mV | between 323 and 552 Vac input voltage change |
| Load regulation | max. | 100 mV | between 0 and 600 W output load, static value |
| Ripple and noise voltage | max. | 100 mVpp | bandwidth 20 Hz to 20 MHz, 50 Ohm |
| Total output power | nom. | 500 W | up to +55 °C ambient temperature, for all outputs in total |
| | nom. | 350 W | up to +70 °C ambient temperature, for all outputs in total |
| BonusPower | nom. | 600 W | up to +45 °C ambient temperature, for all outputs in total |
| Short term up to 5 s | nom. | 1000 W | up to +55 °C ambient temperature, for all outputs in total |
| | nom. | 700 W | up to +70 °C ambient temperature, for all outputs in total |
| | | | Derate linearly between +45 °C and +70 °C, see Fig. 16-1. |
| Overload / short-circuit current | typ. | 21 A / 0 A | continuous current, see Fig. 6-1 At heavy overloads (when output voltage falls below 26 V), the power supply delivers continuous output current for 2 s. After this, the output is switched off for approx. 18 s before a new start attempt is automatically performed. This cycle is repeated as long as the overload exists. Once the overload has been cleared, the device will operate normally, see Fig. 6-2. Load impedance 10 mOhm. Discharge current of output capacitors is not included. |
| Output capacitance | typ. | 6 680 µF | included inside the power supply, for all outputs in total |
| Back-feeding loads | | | See chapter Back-Feeding Loads. |

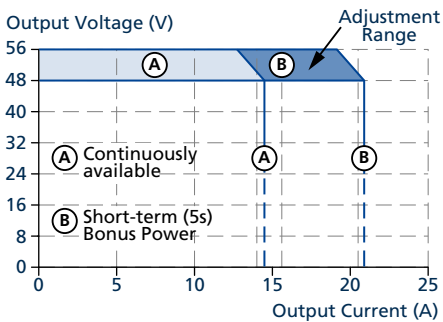

Fig. 6-1: Output voltage vs. output current

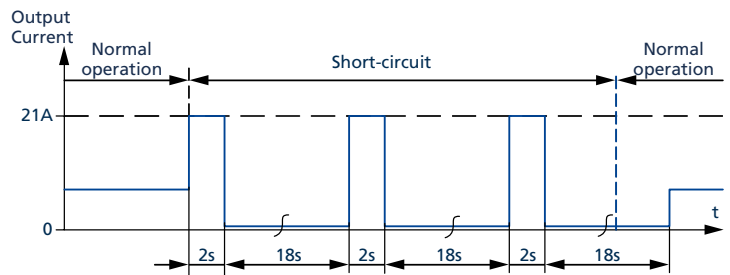

Fig. 6-2: Short-circuit on output, overcurrent mode, typ.

7. Hold-up Time

The hold-up time is the time during which a power supply's output voltage remains within specification following the loss of input power. The hold-up time is output load dependent. At no load, the hold-up time can be up to several seconds. The status LED is also on during this time.

| | | 3AC 400 V | 3AC 480 V | |
|--------------|------|-----------|-----------|------------------------------------|
| Hold-up time | typ. | 56 ms | 56 ms | at 250 W output load, see Fig. 7-1 |
| | min. | 47 ms | 47 ms | at 250 W output load, see Fig. 7-1 |
| | typ. | 24 ms | 24 ms | at 500 W output load, see Fig. 7-1 |
| | min. | 20 ms | 20 ms | at 500 W output load, see Fig. 7-1 |

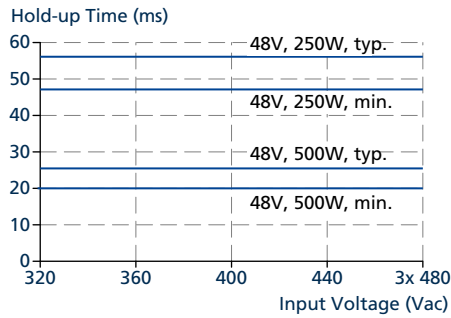

Fig. 7-1: Hold-up time vs. input voltage

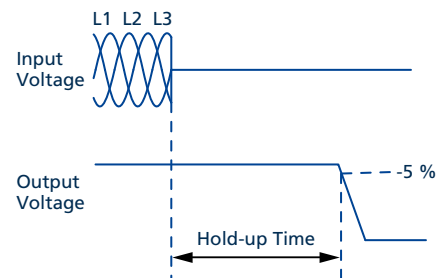

Fig. 7-2: Shut-down behavior, definitions

8. DC-OK Relay Contact

This feature monitors the output voltage, which is produced by the power supply itself. It is independent of an eventually present external voltage on the output of the power supply.

| | |
|----------------------|---|
| Contact closes | As soon as the output voltage reaches typ. 90 % of the adjusted output voltage. The DC-OK relay contact is synchronized with the status LED. |
| Contact opens | As soon as the output voltage dips below 90 % of the adjusted output voltage. Short dips will be extended to a signal length of 100 ms. Dips shorter than 1 ms will be ignored. |
| Switching hysteresis | 1 V |
| Contact ratings | maximal 60 Vdc 0.3 A, 30 Vdc 1 A, 30 Vac 0.5 A, resistive load minimal permissible load: 1 mA at 5 Vdc |
| Isolation voltage | see chapter 18, dielectric strength table |

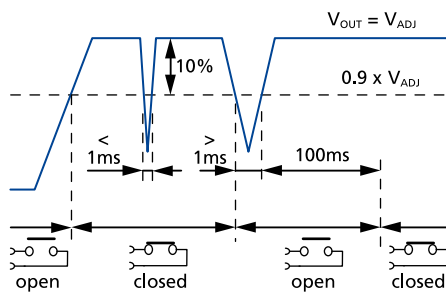

Fig. 8-1: DC-OK relay contact behavior

9. Efficiency and Power Losses

| | | 3AC 400 V | 3AC 480 V | |
|----------------------------------|------|-----------|-----------|---|
| Efficiency | typ. | 96.6 % | 96.3 % | at 48 V, 500 W |
| Average efficiency ¹⁾ | typ. | 95.8 % | 95.4 % | 25 % at 120 W, 25 % at 250 W, 25 % at 370 W, 25 % at 500 W |
| Power losses | typ. | 2.5 W | 3 W | at 48 V, 0 W |
| | typ. | 10 W | 11 W | at 48 V, 250 W |
| | typ. | 17.3 W | 18.7 W | at 48 V, 500 W |
| | typ. | 21.2 W | 22.4 W | at 48 V, 600 W |

1) The average efficiency is an assumption for a typical application where the power supply is loaded with 25 % of the nominal load for 25 % of the time, 50 % of the nominal load for another 25 % of the time, 75 % of the nominal load for another 25 % of the time and with 100 % of the nominal load for the rest of the time.

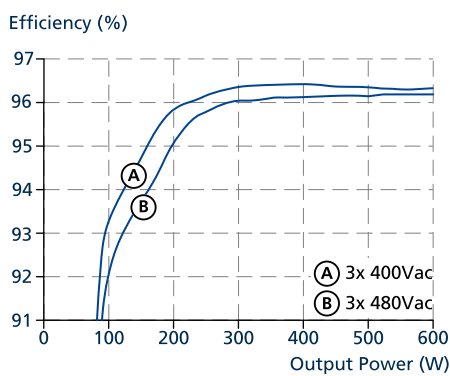

Fig. 9-1: Efficiency vs. output power at 48 V, typ.

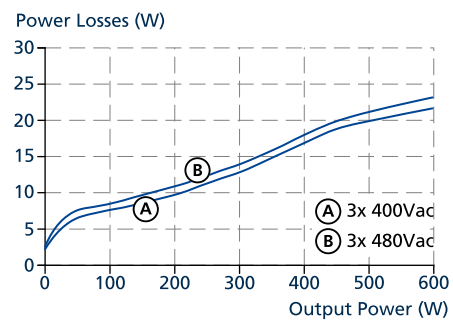

Fig. 9-2: Losses vs. output power at 48 V, typ.

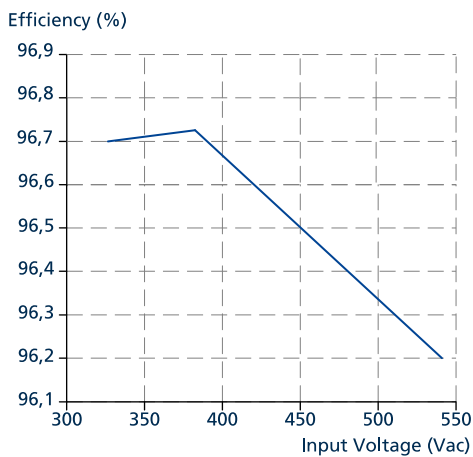

Fig. 9-3: Efficiency vs. input voltage at 48 V, 500 W, typ.

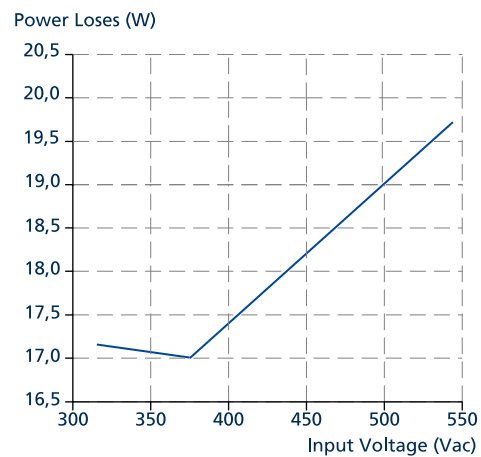

Fig. 9-4: Losses vs. input voltage at 48 V, 500 W, typ.

10. Lifetime Expectancy

The lifetime expectancy shown in the table indicates the minimum operating hours (service lifetime) and is determined by the lifetime expectancy of the built-in electrolytic capacitors. Lifetime expectancy is specified in operational hours and is calculated according to the capacitor’s manufacturer specification. The manufacturer of the electrolytic capacitors only guarantees a maximum lifetime of up to 15 years (131 400 h). Any number exceeding this value is a calculated theoretical lifetime, which can be used to compare devices.

| | 3AC 400 V | 3AC 480 V | |
|--------------------------------|-----------|-----------|---------------------------|
| Calculated lifetime expectancy | 78 000 h | 74 000 h | at 48 V, 500 W and +40 °C |
| | 218 000 h | 185 000 h | at 48 V, 250 W and +40 °C |
| | 139 000 h | 133 000 h | at 48 V, 500 W and +25 °C |
| | 615 000 h | 525 000 h | at 48 V, 250 W and +25 °C |

11. MTBF

MTBF stands for **Mean Time Between Failures**, which is calculated according to statistical device failures, and indicates reliability of a device. It is the statistical representation of the likelihood of a unit to fail and does not necessarily represent the lifetime of a product.

An MTBF figure of e.g. 1 000 000 h means that statistically one unit out of 10 000 installed units will fail every 100 h. However, it can not be determined if the failed unit has been running for 50 000 h or only for 100 h.

For these types of units the MTTF (**Mean Time To Failures**) value is the same value as the MTBF value.

| | 3AC 400 V | 3AC 480 V | |
|--------------------------|-----------|-----------|---|
| MTBF SN 29500, IEC 61709 | 315 000 h | 290 000 h | at 48 V, 500 W and +40 °C |
| | 580 000 h | 537 000 h | at 48 V, 500 W and +25 °C |
| MTBF MIL HDBK 217F | 127 000 h | 120 000 h | at 48 V, 500 W and +40 °C; Ground Benign GB40 |
| | 193 000 h | 184 000 h | at 48 V, 500 W and +25 °C; Ground Benign GB25 |
| | 33 000 h | 35 000 h | at 48 V, 500 W and +40 °C; Ground Fixed GF40 |
| | 47 000 h | 45 000 h | at 48 V, 500 W and +25 °C; Ground Fixed GF25 |

12. Functional Diagram

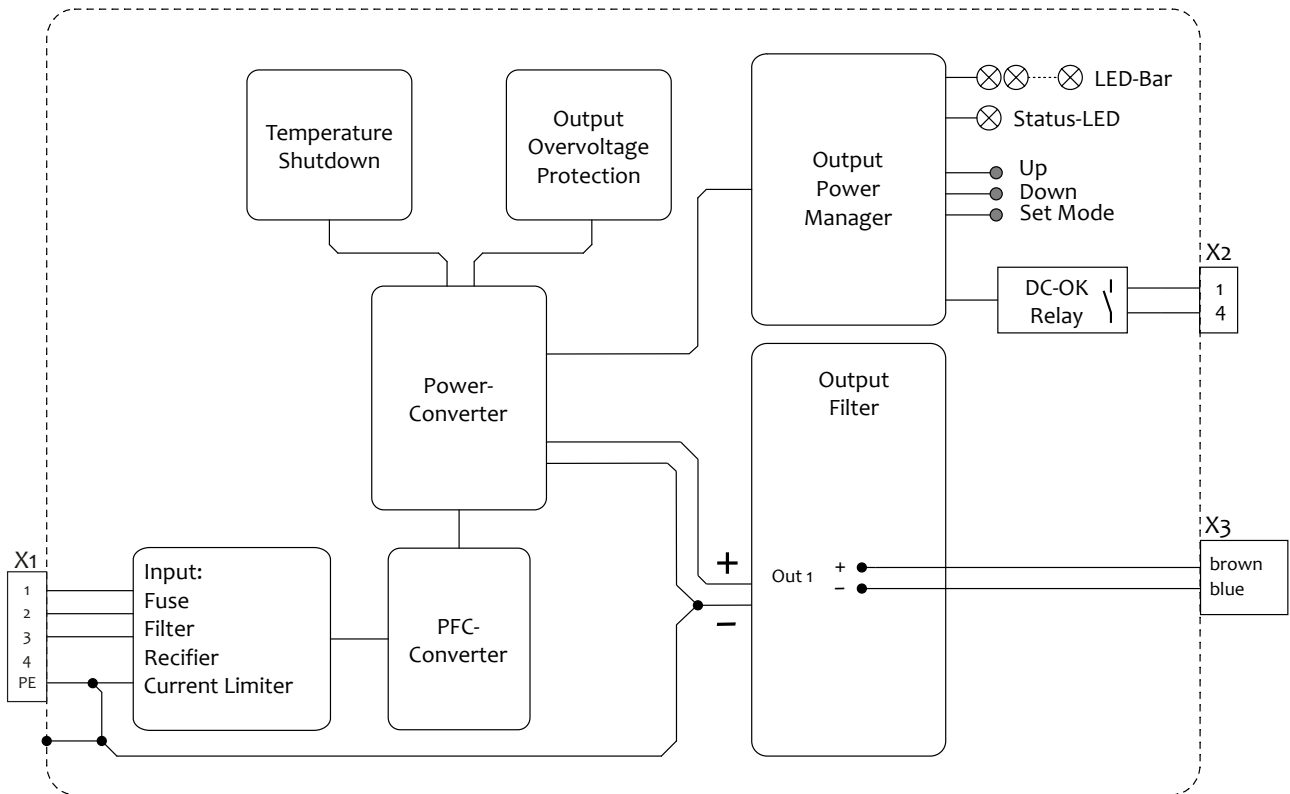
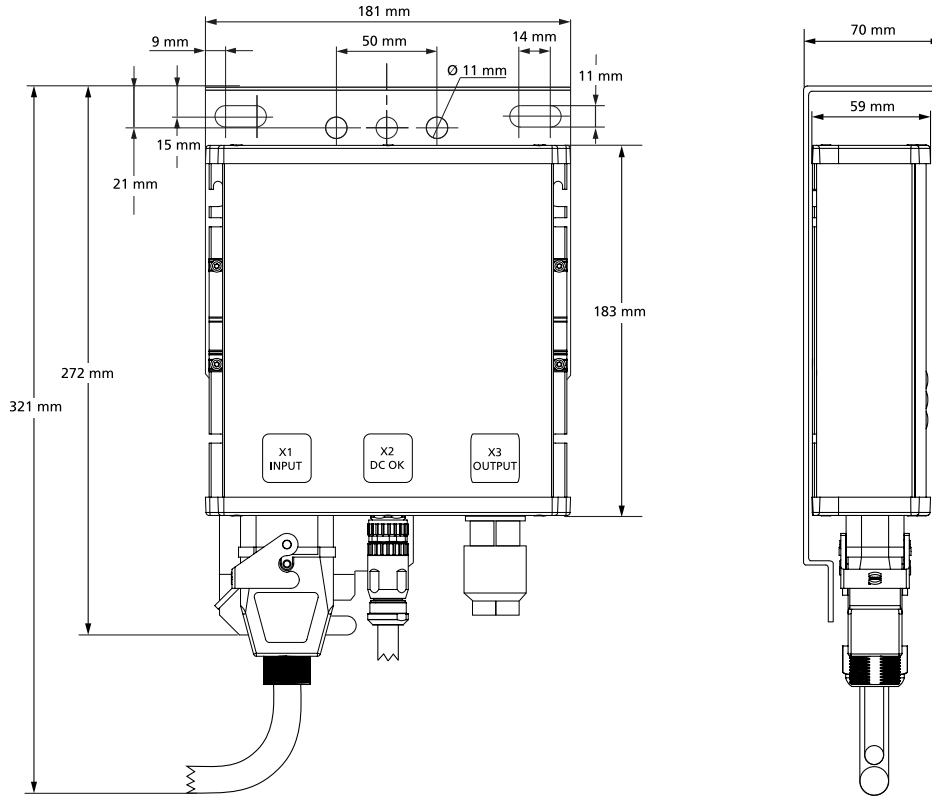

Fig. 12-1: Functional Diagram FPT500.481-008-103

13. Dimensions and Connectors



Width: 181 mm
 Height: 272 mm
 Depth: 70 mm
 Weight: 1550 g

Housing body material: Aluminium alloy
 Housing cover material: Hi-grade polycarbonate
 Installation clearances: See chapter 2

Input connector on power supply (X1):

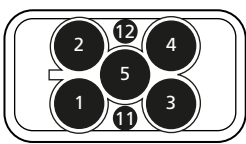

Han Q 4/2 male

Pin 1: L1
 Pin 2: L2
 Pin 3: L3
 Pin 4: Not connected
 Pin 5: PE connection ⚡

DC-OK connector on power supply (X2):

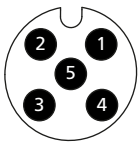

M12-A 5pin male

Pin 1: Relay connection
 Pin 2: Not connected
 Pin 3: Not connected
 Pin 4: Relay connection
 Pin 5: Not connected

Output connector on power supply (X3):

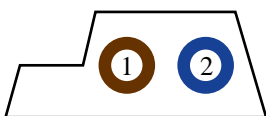

ASI cable 2.5mm²

Brown cable (1): 48 Vdc
 Blue cable (2): GND

All parameters are specified at 48 V, 500 W, 3x 400 Vac, 25 °C ambient and after a 5 minutes run-in time unless otherwise noted.

14. User Interface

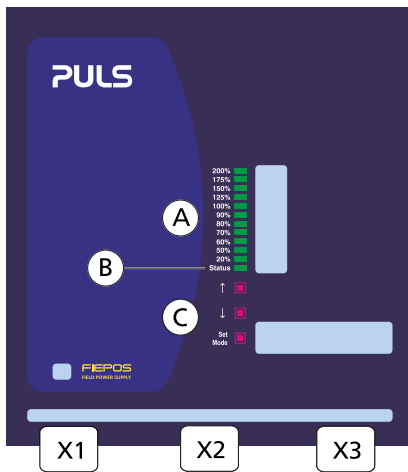

| | |
|----|--------------------------------|
| X1 | Input connector |
| X2 | DC-OK connector |
| X3 | Output connector |
| A | LED bar |
| B | Status LED |
| C | Set Mode and UP / DOWN buttons |

Overview

LED bar (A)

The LED bar is a multifunctional display. The main function is to monitor the sum of all outputs (percentages scale). It also can display the output voltage (voltage scale) and output power (percentage scale) for the individual outputs. The integrated status LED displays different running conditions of the device in real-time.

Status LED (B)

The Status LED displays different running conditions of the device in real-time.

Output level controls (C)

The output level controls consist of the Set Mode button and the UP / DOWN buttons. The Set Mode button is used to change into tripping current settings. The UP / DOWN buttons are used to adjust different output levels or change into the output current mode.

Operation settings

Monitor output power mode

The output power mode displays the actual total output power after startup. It is the default mode of the LED bar. The output power is displayed in percentages of 500 W. If the LED bar is powered up till e.g. 50 %, 250 W is expended. If the LED bar rises above 100 % and therefore exceeds 500 W the 125 %-LED flashes orange. Refer to the percentage scale on the left sidebar.

Set output voltage

To set a new output voltage:

- Press Set Mode button for 3 s. The LED bar lights up once and the set voltage is displayed.
- Push UP / DOWN button to increase or decrease the set point, see voltage scale on the right sidebar.
- New point is set.
- After 15 s of non-action, the device will automatically switch to output power mode.

Set button lock

To activate / deactivate the button lock:

- Press the UP / DOWN buttons simultaneously for 3 s. The LED bar will flash for 5 s to indicate the changed button lock status.

LED signaling

The Status LED (B) displays different running conditions of the device in real-time.

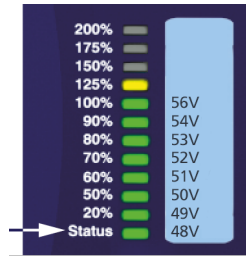



- 
Green: On
 DC voltage is above 90 % of output voltage and all outputs are operating according to their settings.

- 
Off
 DC voltage is below 90 % of output voltage or power supply is not powered.

- 
Orange: Two face operation
 See chapter 22.4.

- 
Flashes orange: Overcurrent
 Output is off during these 18 s.

- 
Red: AC input failure
 AC input drops below the specified levels.

- 
Flashes red: Overtemperature
 The unit has turned off due to overtemperature. As soon as the temperature reaches normal operating range the output turns on again and the status LED changes to solid green.

15. EMC

The EMC behavior of the device is designed for applications in industrial environment as well as in residential, commercial and light industry environments.

The device is investigated according to EN 61000-6-1, EN 61000-6-2, EN 61000-6-3, EN 61000-6-4, EN 61000-3-2 and EN 61000-3-3.

EMC Immunity

| | | | | |
|----------------------------|---------------|--|------------------|-------------|
| Electrostatic discharge | EN 61000-4-2 | contact discharge | 8 kV | Criterion A |
| Air discharge | | air discharge | 15 kV | Criterion A |
| Electromagnetic RF field | EN 61000-4-3 | 80 MHz - 1 GHz | 20 V/m | Criterion A |
| | | 1 GHz - 6 GHz | 10 V/m | Criterion A |
| Fast transients (Burst) | EN 61000-4-4 | AC input lines | 4 kV | Criterion A |
| | | DC output lines | 2 kV | Criterion A |
| | | DC-OK | 2 kV | Criterion A |
| Surge voltage on AC input | EN 61000-4-5 | L1 → L2, L2 → L3, L1 → L3 | 2 kV | Criterion A |
| | | L1 / L2 / L3 → PE | 4 kV | Criterion A |
| Surge voltage on DC output | EN 61000-4-5 | (+) → (-) | 1 kV | Criterion A |
| | | (+) / (-) → PE | 2 kV | Criterion A |
| Surge voltage on DC-OK | EN 61000-4-5 | DC-OK → PE | 1 kV | Criterion A |
| Conducted immunity | EN 61000-4-6 | AC input | 20 V | Criterion A |
| | | DC output | 20 V | Criterion A |
| | | DC-OK | 20 V | Criterion A |
| Voltage dips | EN 61000-4-11 | 0 % of 380 V | 0 Vac, 20 ms | Criterion A |
| | | 40 % of 380 V | 152 Vac, 200 ms | Criterion A |
| | | 70 % of 380 V | 266 Vac, 500 ms | Criterion A |
| Voltage interruptions | EN 61000-4-11 | 0 % of 380 Vac | 0 Vac, 5000 ms | Criterion C |
| Voltage sags | SEMI F47 | dips on the input voltage according to SEMI F47 standard | | |
| | | 80 % of 380 Vac | 304 Vac, 1000 ms | Criterion A |
| | | 70 % of 380 Vac | 266 Vac, 500 ms | Criterion A |
| | | 50 % of 380 Vac | 190 Vac, 200 ms | Criterion A |
| Powerful transients | VDE 0160 | over entire load range | 1550 V, 1.3 ms | Criterion A |

Performance criterions:

A: The device shows normal operation behavior within the defined limits.

C: Temporary loss of function is possible. The device may shut down and restart by itself. No damage or hazards for the device will occur.

EMC Emission

| | | |
|------------------------------------|--------------------------------------|--|
| Conducted emission AC input lines | EN IEC 61000-6-3, EN 55032, EN 55011 | Class B |
| Conducted emission DC output lines | EN IEC 61000-6-3 | |
| Radiated emission | EN IEC 61000-6-3, EN 55032, EN 55011 | Class B |
| Harmonics | EN 61000-3-2 | pass for Class A equipment |
| Voltage fluctuations, flicker | EN 61000-3-3 | pass tested with constant current loads, non pulsing |

This device complies with FCC Part 15 rules.

Operation is subjected to following two conditions: (1) this device may not cause harmful interference, and (2) this device must accept any interference received, including interference that may cause undesired operation.

Switching Frequencies

| | | |
|------------------------|-------------------|---|
| PFC converter | 20 kHz to 135 kHz | input voltage and output load dependent |
| Main converter | 60 kHz to 140 kHz | output load dependent |
| Auxiliary converter | 54 kHz to 66 kHz | output load dependent |
| Microcontroller clocks | 48 MHz and 32 MHz | fixed frequency |

16. Environment

| | | |
|-------------------------|---|---|
| Operational temperature | -30 °C to +70 °C | Operational temperature is the same as the ambient or surrounding temperature and is defined as the air temperature 3 cm below the unit. |
| Storage temperature | -40 °C to +85 °C | for storage and transportation |
| Output derating | 10 W / °C 33 W / 1000 m or 5 °C / 1000 m for altitudes > 2000 m, see Fig. 16-2 The derating is not hardware controlled. The application has to stay below the derated current limits in order not to overload the unit. | between +45 °C and +70 °C, see Fig. 16-1 |
| Humidity | 5-95 % r.h. | according to IEC 60068-2-30 |
| Atmospheric pressure | 54-110 kPa | see Fig. 16-2 |
| Altitude | up to 5000 m | see Fig. 16-2 |
| Overvoltage category | III | according to IEC 60664-1 for TN-, TT-mains systems with earthed neutral and IT star mains systems with insulation monitoring for altitudes up to 2000 m |
| | II | according to IEC 60664-1 for TN-, TT-mains systems with earthed neutral and IT star mains systems with insulation monitoring for altitudes between 2000 m and 5000 m according to IEC 60664-1 for TN-, TT-, IT-delta mains systems or IT star mains systems without insulation monitoring for altitudes up to 2000 m |
| Degree of pollution | 3 | according to IEC/UL 61010-1 |
| Vibration sinusoidal | 2-17.8 Hz: ±1.6 mm; 17.8-500 Hz: 2 g 2 hours / axis | according to IEC 60068-2-6 |
| Shock | 30 g 6 ms, 20 g 11 ms 3 bumps / direction, 18 bumps in total | according to IEC 60068-2-27 |
| | Shock and vibration is tested in combination with DIN rails according to EN 60715 with a height of 15 mm and a thickness of 1.3 mm and standard orientation. | |
| Audible noise | Some audible noise may be emitted from the power supply during no load, overload or short circuit. | |

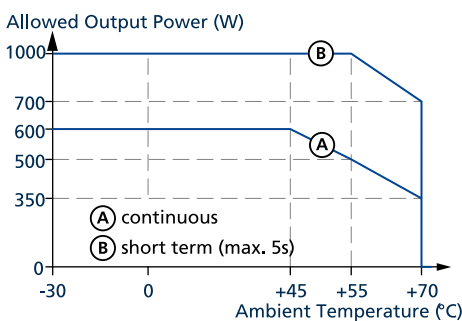

Fig. 16-1: Output power vs. ambient temp.

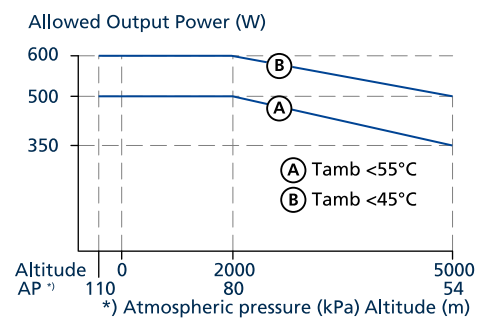

Fig. 16-2: Output power vs. altitude

17. Safety and Protection Features

| | | | |
|-------------------------------|------|--|---|
| Isolation resistance | min. | 500 MOhm | at delivered condition between input and output, measured with 500 Vdc |
| | min. | 500 MOhm | at delivered condition between input and PE, measured with 500 Vdc |
| | min. | 500 MOhm | at delivered condition between output and DC OK contacts, measured with 500 Vdc |
| PE resistance | max. | 0.1 Ohm | resistance between PE terminal and housing |
| Input / Output separation | | PELV/ES1 | IEC/EN/UL 61010-2-201, IEC/EN 62368-1, IEC/EN 60950-1 |
| Output overvoltage protection | max. | 60 Vdc In case of an internal defect, a redundant circuit limits the maximum output voltage. The output shuts down and automatically attempts to restart. | |
| Class of protection | | I | according to IEC 61140 a PE (Protective Earth) connection is required |
| Degree of protection | | IP54 | according to EN/IEC 60529 |
| Overtemperature protection | | included | Output shut down with automatic restart. Temperature sensors are installed on critical components inside the unit and the unit turns off in safety critical situations, which can happen, e.g. when ambient temperature is too high, ventilation is obstructed or the derating requirements are not followed. There is no correlation between the operating temperature and turn-off temperature since this is dependent on input voltage, load and installation methods. |
| Input transient protection | | MOV (Metal Oxide Varistor) | for protection values, see chapter 15. |
| Internal input fuse | | included | not user replaceable slow-blow high-breaking capacity fuse, 6.3 A (T) |
| Leakage current | max. | 0.56 mA _{rms} | at 552 Vac, 60 Hz, TN-,TT-mains / IT-mains |

18. Dielectric Strength

The negative terminals of the outputs are permanently connected to PE within the unit. The output is separated from the input by a double or reinforced insulation.

Type and routine tests are conducted by the manufacturer. Field tests may be conducted in the field using the appropriate test equipment which applies the voltage with a slow ramp (2 s up and 2 s down). Connect all input terminals before conducting the test. When testing, set the cut-off current settings to the value in the table below.

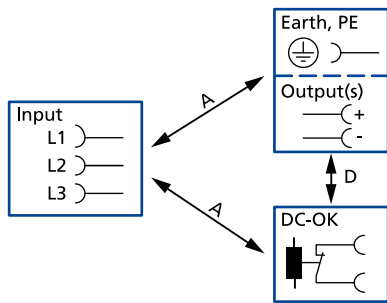





Fig. 18-1: Dielectric strength

| | | A | D |
|--|------|----------|----------|
| Type test | 60 s | 2830 Vac | 500 Vac |
| Routine test | 5 s | 2550 Vac | 500 Vac |
| Field test | 5 s | 2000 Vac | 500 Vac |
| Cut-off current setting for field test | | > 10 mA | > 10 mA |

19. Approved, Fulfilled or Tested Standards

| | | |
|------------|---|---|
| IEC 62368 | CB Report | CB Scheme Certificate IEC 62368-1 - Audio / video, information and communication technology equipment - Safety requirements Output safety level: ES1 |
| IEC 61010 | CB Report | CB Scheme Certificate IEC 61010-2-201 - Electrical Equipment for Measurement, Control and Laboratory Use - Particular requirements for control equipment |
| IEC 60950 | Safety ✓ | Manufacturers Declaration IEC 60950-1 – General safety requirements for Information Technology Equipment (ITE) |
| UL 61010 |  | UL Certificate Listed equipment for category NMTR - UL 61010-2-201 - Electrical equipment for measurement, control and laboratory use - Particular requirements for control equipment Applicable for US and Canada E-File: E198865 |
| Semi F47 | SEMI F47 | Test Report Voltage Sag Immunity for Semiconductor Processing Equipment Tested for AC 400 V L-L mains voltages, nominal output voltage and nominal output load |
| VDMA 24364 | LABS VDMA 24364-C1-L/W | Paint Wetting Impairment Substances Test (or LABS-Test) Tested for Zone 2 and Test Class C1 according to VDMA 24364-C1-L/W for solvents and water-based paints |

20. Regulatory Product Compliance

| | | |
|------------------------------|---|---|
| EU Declaration of Conformity |  | The CE mark indicates conformance with the European <ul style="list-style-type: none"> - EMC directive - Low-voltage directive (LVD) - RoHS directive |
| WEEE Directive |  | Manufacturer's Declaration EU-Directive on Waste Electrical and Electronic Equipment (WEEE) registered in Germany as business to business (B2B) products. WEEE-Reg.-Nr. DE 55837529 |
| REACH Regulation (EU) | REACH ✓ | Manufacturer's Statement EU regulation regarding the Registration, Evaluation, Authorisation and Restriction of Chemicals (REACH) fulfilled. |
| RoHS-China |  | Manufacturer's Statement Administrative Measures for the Restriction of the Use of Hazardous Substances in Electrical and Electronic Products 25 years |
| IEC/EN 61558-2-16 (Annex BB) | Safety Isolating Transformer | Safety Isolating Transformers corresponding to Part 2-6 of the IEC/EN 61558 |

21. Accessories

21.1. DIN Rail Mounting Kit: ZM.FPDRA-11

In addition to screw mounting FIEPOS can easily be attached to a DIN rail using the ZM.FPDRA-11 DIN rail mounting kit.

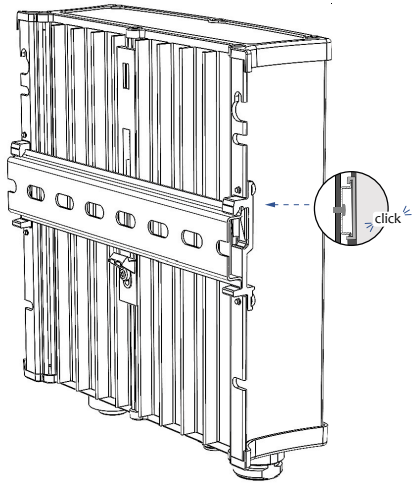

- DIN rail not included

21.2. Mounting Bracket: ZM.FPMBA-11

In addition to screw mounting FIEPOS can easily be attached onto surfaces using the mounting bracket ZM.FPMBA-11.

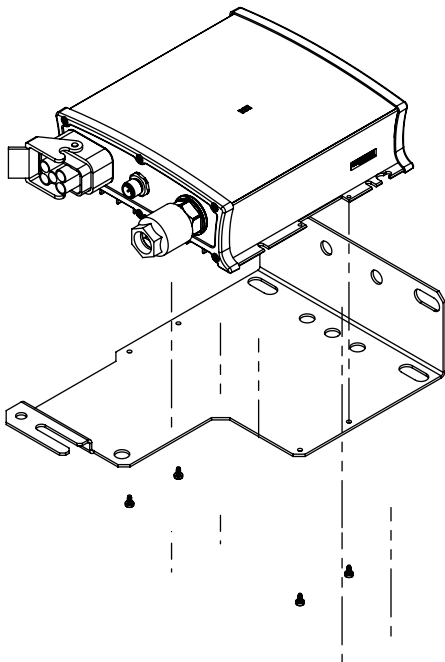

22. Application Notes

22.1. Repetitive Pulse Loading

Typically, a load current is not constant and varies over time. This power supply is designed to support loads with a higher short-term power demand. The short-term duration is hardware controlled by an output power manager and is available on a repeated basis. If the average load is higher than the sum of all output power, the output voltage will dip.

To avoid this, the following rules must be followed:

- a) The power demand of the pulse must be below 200 % of the nominal output power.
- b) The duration of the pulse power must be shorter than the allowed short-term power time, see chapter 6.
- c) The average power should be lower than the nominal output power.

The R.M.S. output current must be below the specified continuous output current. If the R.M.S. current is higher, the unit may respond with a thermal shut-down after a period of time.

22.2. External Input Protection

The device is designed, tested and approved for branch circuits up to 30 A (UL) and 32 A (IEC) without an additional protection device. If an external device (fuse or circuit breaker) is utilized, do not use fuses or circuit breaker smaller than 6 A B- or C-Characteristic to avoid a unintentional tripping.

22.3. Inductive and Capacitive Loads

The power supply is designed to supply any kind of loads, including capacitive and inductive loads. If extreme large capacitors, such as EDLCs (electric double layer capacitors or "UltraCaps") with a capacitance larger than 100 mF are connected to the output, the power supply might charge the capacitor or the output might trip, see chapter 6.

22.4. Two Phases Operation

No external protection devices are required to protect against a phase-loss.

Continuous two phase operation is not recommended for this power class since the supplying 3-phase network could become unbalanced. However, if one phase fails, the unit may continue to operate if the load is below the power limit shown in Fig. 22-1.

Exceeding these limits for an extended period may result in a thermal shut-down of the unit.

During power-on, some start-up attempts can occur until a permanent output power is available. EMC performance, hold-up time, losses, and output ripple differ from a three phase operation. Such use is not included in the approval according to UL 61010 and IEC 62368.

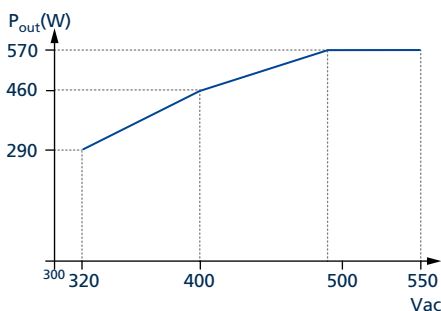
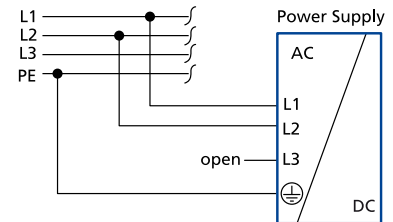

Fig. 22-1: Two phase power capability

22.5. Back-Feeding Loads

Loads such as decelerating motors and inductors can feed voltage back to the power supply. This feature is also called return voltage immunity or resistance against Back- E.M.F. (Electro Magnetic Force).

This energy is fed back into the system, where it can be converted into heat by the braking resistor integrated in the power supply unit. The chopper is activated when the output voltage is exceeded by about 2.5 V (0.5 V hysteresis)

The value of our resistor is 3.3 Ohm.

Single pulse can be handled up to 50 J.

The integrated chopper is protected against thermal overload. If the thermal protection is activated, the converter is disabled to prevent further back EMF events. After the cool-down phase, the converter restarts automatically.

Maximum allowed average back EMF according to graph below.

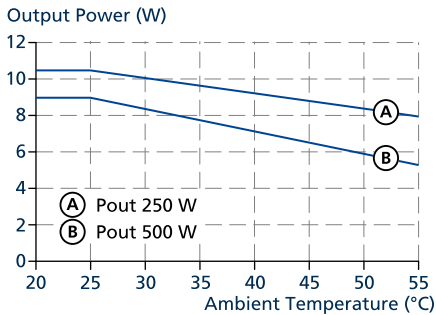

22.6. Parallel Use to Increase Output Power

Do not use parallel devices for higher output currents.

22.7. Series Operation

Do not connect power supplies in series.

22.8. Mounting Orientations

The device can be panel mounted in various mounting orientations. The listed lifetime and MTBF values from this datasheet apply only for the standard mounting orientation. The following curves give an indication for allowed output power in different mounting orientations for altitudes up to 2000 m.

A
Standard orientation

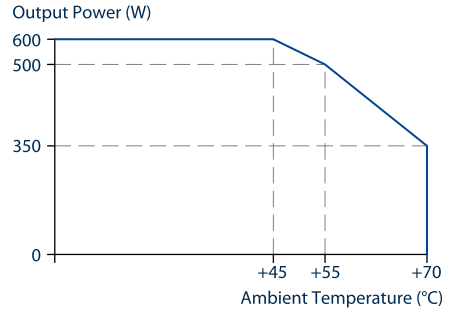
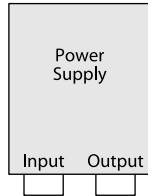

B
Upside down

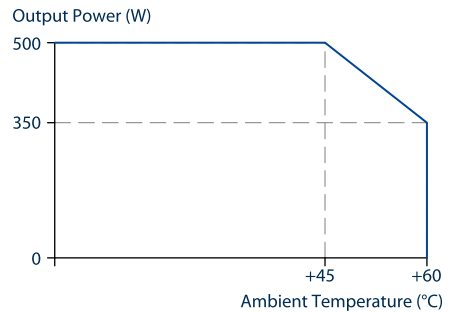
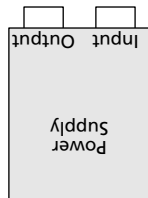

C
Horizontal clockwise
and counter clockwise

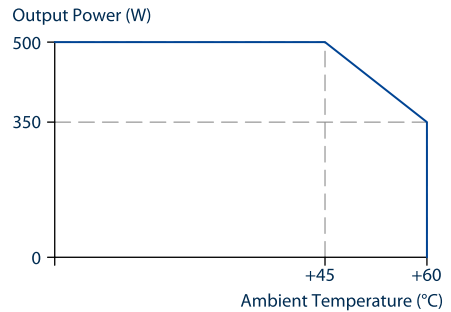

D
Overhead and tabletop
mounting

