

Product Description

The SLZ10 is a mechanical adaptor to mount a DIN-rail device on a Siemens S7-300 mounting rail.

The order number SLZ10 contains one bracket and two screws needed to fix the adaptor onto the Siemens S7-300 rail.

Intended Use

This mechanical adaptor is designed for DIN-rail devices with a specific unit width shorter than the bracket width.

Technical Data

Size (width x height x depth) 42x124.7x19mm

Weight 80g / 0.18lb

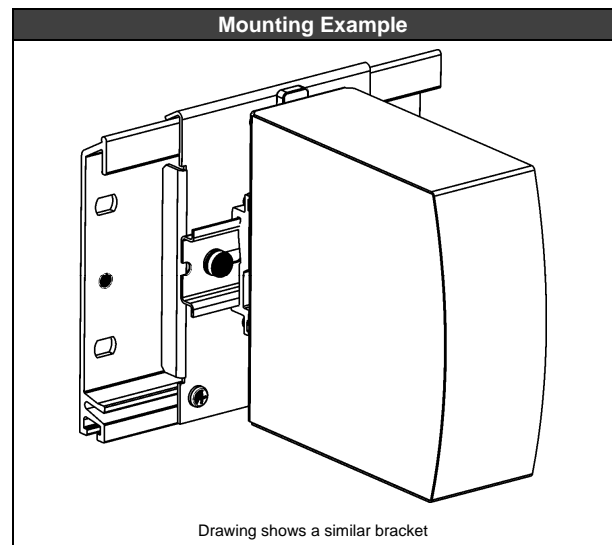
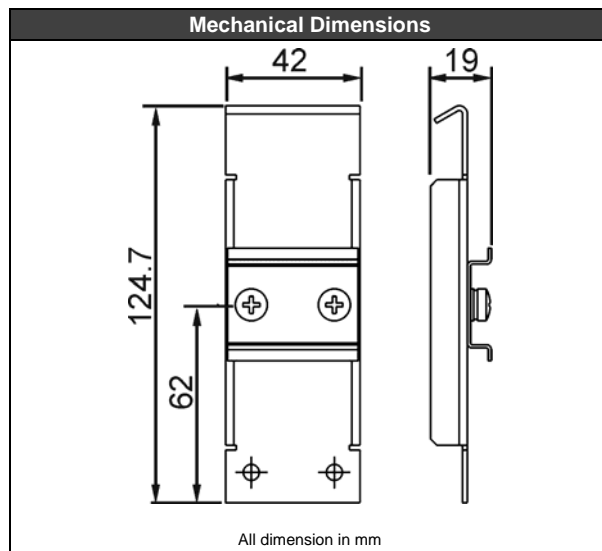

Headquarters: PULS GmbH, Elektrastr. 6, 81925 Munich, Germany, www.pulspower.com

Germany +49 89 9278 0

France +33 478 668 941

Austria +43 2764 3213

Switzerland +41 56 450 18 10

China +86 512 62881820

North America +1 630 587 9780

Singapore +65 6684 2310

United Kingdom +44 1525 841001

The information in this document is believed to be accurate and reliable and may change without notice.

Installation Instructions

- 1) Click the adapter on any given place on the Siemens S7-300 mounting rail.
- 2) Insert the two module screws provided with the bracket and manually tighten the screws.
- 3) Click the DIN-rail device on the DIN-rail.

