

POWER SUPPLY 100-240Vac 24V 300W

- IP 65/67 Degree of protection
- 600 W_{peak} 5 s
- 1AC 100-240 V wide-range input
- 2 switchable outputs
- Outputs for actors and sensors separately protected
- 95.7 % full load and excellent partial load efficiencies
- DIN rail mounting possible, option "D"
- Output connected to PE (PELV)
- Version without connection to PE on request
- Large output capacitors
- Not potted
- Negligible low input inrush current surge
- Full power between -25 °C and +55 °C
- IO-Link
- 3 years warranty

GENERAL DESCRIPTION

The FPS300 is an industrial grade power supply for the 1-phase mains system, it is incorporated into a rugged wall-mount housing with an IP65/67 degree of protection.

It provides two to four stabilized outputs that are galvanically separated from the input. The negative potential of the outputs is permanently connected to PE within the unit.

The most outstanding features of the FPS series are the compact size, the wide operating temperature range, the extremely low input inrush current and the very high efficiencies, which are achieved through various design technologies. Large output capacitors can absorb and store regenerative energy from breaking motors.

Various connector options support the different needs of individual applications. Please contact PULS for possible options. High immunity to transients and power surges as well as low electromagnetic emissions and an international approval package makes the use in nearly every application possible.

SHORT-FORM DATA

Output voltage	DC 24 V	Nominal
Adjustment range	24-28 V	Factory setting 24.5 V
Output power	Continuous: 360 / 300 / 150 W	Up to: +45 / +55 / +70 °C
	Short term up to 5 s	
	600 / 300 W	+55 / +70 °C
Derate linearly	+55 °C to +70 °C	
Number of output	2	
Output currents	Settable per output; up to 10 A	
Input voltage AC	1AC 100-240 V	-15 / +10 %
Input voltage DC	DC 110-300 V*)	±20 %
Power factor	0.99 / 0.97	At 120 / 230 Vac
AC Inrush current	2.6 / 6 A _{peak}	At 120 / 230 Vac
Efficiency	94.3 / 95.7 %	At 120 / 230 Vac
Losses	18.1 / 13.5 W	At 120 / 230 Vac
Hold-up time	44 / 44 ms	At 120 / 230 Vac
Temperature range	-25 °C to +70 °C	
Size (wxhxd)	181x183x59 mm	Without connectors
Weight	1200 g / 2.7 lb	

*) For DC supply voltages above 150 Vdc an external fuse is required.

ORDER NUMBERS

Description:	Power supply FPS300	
Order Number	Input	Output
FPS300.245-016-101*	7/8" 3pin	7/8" 5pin

Accessories:	Chapter 21
Related Products	Chapter 22

*For DIN rail mounting PSU: (Order Number)D
e.g. FP300.245-016-101D

MAJOR APPROVALS AND CONFORMITY

For details or a complete approval list, see chapter 21.

CB Report



IEC 62368-1
IEC 61010-2-201

INDEX



INDEX	2	19. Approvals and Fulfilled Standards.....	28
1. Intended Use	4	20. Regulatory Compliance	28
2. Installation Instructions	4	21. Accessories	29
3. AC-Input	5	21.1. DIN RAIL Mounting KIT: ZM.FPDRA-11	29
4. DC-Input	6	21.2. Mounting Braket: ZM.FPMBA-11.....	29
5. Input Inrush Current	6	21.3. Connectors.....	30
6. Output	7	22. Related Products.....	31
7. Hold-up Time	9	23. Application Notes.....	32
8. IO-Link Interface	10	23.1. Repetitive Pulse Loading.....	32
9. Efficiency and Power Losses	16	23.2. External Input Protection.....	32
10. Lifetime Expectancy.....	17	23.3. Inductive and Capacitive Loads	32
11. MTBF.....	17	23.4. Back Feeding Loads.....	32
12. Functional Diagram	18	23.5. Mounting Orientations	33
13. Dimensions and Connector Variants.....	19	24. IO-Link Data Types and Description	34
14. User Interface.....	20	24.1. Cyclic Data	34
15. EMC.....	23	24.2. Acyclic data.....	36
16. Environment.....	25	24.3. Events.....	42
17. Safety and Protection Features	26		
18. Dielectric Strength	27		

The information given in this document is correct to the best of our knowledge and experience at the time of publication. If not expressly agreed otherwise, this information does not represent a warranty in the legal sense of the word. As the state of our knowledge and experience is constantly changing, the information in this data sheet is subject to revision. We therefore kindly ask you to always use the latest issue of this document (available under www.pulspower.com).

No part of this document may be reproduced or utilized in any form without our prior permission in writing.

Packaging and packaging aids can and should always be recycled. The product itself may not be disposed of as domestic refuse.

TERMINOLOGY AND ABBREVIATIONS

PE and  Symbol	PE is the abbreviation for Protective Earth and has the same meaning as the symbol  .
Earth, Ground	This document uses the term "earth" which is the same as the U.S. term "ground".
T.b.d.	To be defined, value or description will follow later.
AC 230 V	A figure displayed with the AC or DC before the value represents a nominal voltage with tolerances (usually $\pm 15\%$) included. E.g.: DC 12 V describes a 12 V battery disregarding whether it is full (13.7 V) or flat (10 V)
230Vac	A figure with the unit (Vac) at the end is a momentary figure without any additional tolerances included.
50Hz vs. 60Hz	As long as not otherwise stated, AC 100V and AC 230V parameters are valid at 50Hz mains frequency. AC 120V parameters are valid for 60Hz mains frequency.
may	A key word indicating flexibility of choice with no implied preference.
shall	A key word indicating a mandatory requirement.
should	A key word indicating flexibility of choice with a strongly preferred implementation.
Us	Sensor output
Ua	Actor output

All parameters are specified at 24V, 12.5A, 230Vac, 25°C ambient and after a 5 minutes run-in time unless otherwise noted.

NOMENCLATURE

Detail	Description
FPT	380-480 V 3 Phase IP54-67 Power Supply
FPS	100-240 V 1 Phase IP54-67 Power Supply
FPH	200-240 V 1 Phase IP54-67 Power Supply Highline Input Voltage
300	300 W Power Class
500	500 W Power Class
241 / 481	Standard Power Supply with Output Voltage 24-28 V / 48-52 V Setting and LED Bar
242 / 482	Basic Power Supply without Voltage Setting and LED-Bar. This version has a status LED Bar.
245 / 485	Power Supply with up to 4 E-Fuse Channels
246 / 486	Power Supply with up to 4 NEC Class II Channels
247 / 487	Power Supply with NEC Class II and E-Fuse Channel
0xx	Terminal configuration e.g. .002. Input: HanQ4/2 Com: M12-A Output: HanQ4/0
1xx	Consecutively numbered

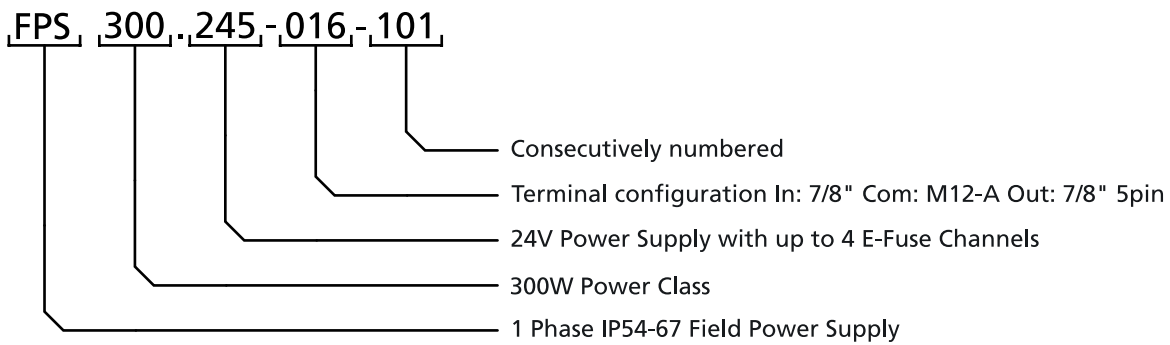

1. Intended Use

This device is designed for indoor use and is intended for commercial applications, such as in industrial control, process control, monitoring and measurement equipment.

Do not use this device in equipment where malfunction may cause severe personal injury or threaten human life. If this device is used in a manner outside of its specification, the protection provided by the device may be impaired.

2. Installation Instructions

⚠ DANGER Risk of electrical shock, fire, personal injury or death.

- Turn power off before working on the device. Protect against inadvertent re-powering.
- Do not open, modify or repair the device.
- Do not touch during power-on and immediately after power-off. Hot surfaces may cause burns.
- Install the device on a large enough flat surface. Sharp edges on the back may cause injury.
- If damages or malfunctioning occur during installation or operation, immediately turn power off and send unit to the factory for inspection.
- The device is designed as “Class of Protection I” equipment according to IEC 61140. Do not use without a proper PE (Protective Earth) connection.

⚠ WARNING Risk of damages on the device

- Keep the following minimum installation clearances: 30 mm on top and bottom, 10 mm on the front and 10 mm left and right side.
- The maximum surrounding air temperature is +70 °C (+158 °F). The operational temperature is the same as the ambient or surrounding air temperature and is defined 2 cm below the device.
- The device is designed to operate in areas between 5 % and 95 % relative humidity.
- Clean only with a damp cloth.

Obey the following installation instructions:

This device may only be installed and put into operation by qualified personnel. This device does not contain serviceable parts. The tripping of an internal fuse is caused by an internal defect. Install the device onto a flat surface with the terminals on the bottom of the device. Other mounting orientations require a reduction in output power, chapter 23.6.

For wall mounting use 4 screws. Two on top and 2 on bottom mounting holes. Recommended screw size is M4 (UNC 8-32). The enclosure of the device provides a degree of protection of IP65/67 when installed with all mating connectors firmly connected. The device is designed for pollution degree 3 areas in controlled environments.

Assure that during installation no moisture or dirt gets into the connections. Operation in areas where moisture or condensation can be expected is possible.

The negative potential of the outputs is permanently connected to PE within the unit. Do not connect the negative potential of any output to PE outside the unit.

For TN,TT mains systems with earthed neutral and IT star mains systems with insulation monitoring the device is designed for overvoltage category III zones up to 2000 m (6560 ft) and for overvoltage category II zones up to 5000 m (16400 ft).

For TN, TT, IT delta mains systems or IT star mains systems without insulation monitoring the device is intended for overvoltage category II zones up to 2000 m (6560 ft).

The device is designed for altitudes up to 5000 m (16400 ft). Above 2000 m (6560 ft) a reduction in output current is required and the operation is limited according mains systems described above. The device is designed, tested and approved for branch circuits up to 20 A (UL) and 32 A (IEC) without additional protection device. If an external fuse is utilized, do not use circuit breakers smaller than 6 A B- or C-characteristic to avoid a nuisance trip. A disconnecting means shall be provided for the input of the device. This must be suitably located and easily accessible. The disconnecting means must be marked as the such for the device.

3. AC-Input

The device is suitable to be supplied from TN, TT or IT mains networks. For more details, please review chapter 2.

AC input voltage rated range	nom.	AC 100-240 V	
AC input operating range		85-264 Vac 264-300 Vac	Continuous operation For maximal 500ms
Input frequency	Nom.	50–60 Hz	±6 %
Turn-on voltage	Typ.	80 Vac	Steady-state value, see Fig. 3-1
Shut-down voltage	Typ.	70 Vac	Steady-state value, see Fig. 3-1
External input protection	See recommendations in chapter 2 .		

		AC 100 V	AC 120 V	AC 230 V	
Input current	typ.	3.98 A	3.2 A	1.68 A	At 360 W, symmetrical phase voltages, see Fig. 3-3 Power
Power factor*)	typ.	0.99	0.99	0.97	At 360 W, see Fig. 3-4
Start-up delay	typ.	2 s	2 s	2 s	At 300 W symmetrical phase voltages, see Fig. 3-2
Rise time	typ.	22 ms	22 ms	22 ms	At 300 W constant current load, 0 mF load, see Fig. 3-2
	typ.	48 ms	46 ms	35 ms	At 300 W constant current load, 12.5 mF, see Fig. 3-2
Turn-on overshoot	Max.	200 mV	200 mV	200 mV	See Fig. 3-2

*) The power factor is the ratio of the true (or real) power to the apparent power in an AC circuit.

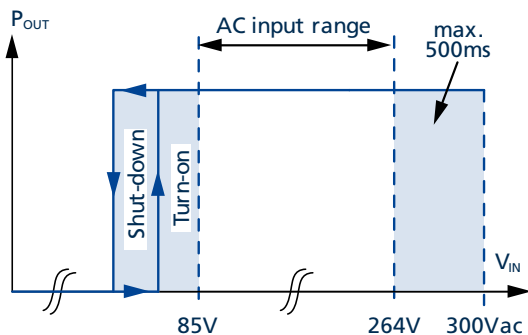

Fig. 3-1: Input voltage range

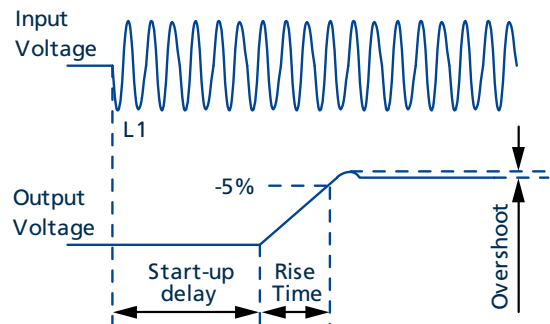

Fig. 3-2: Turn-on behavior, definitions

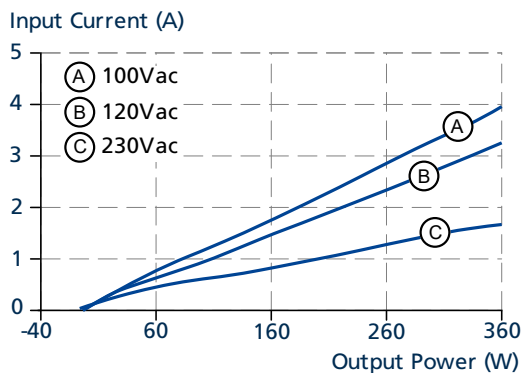

Fig. 3-3:
Input current vs. output power at 24 V output voltage

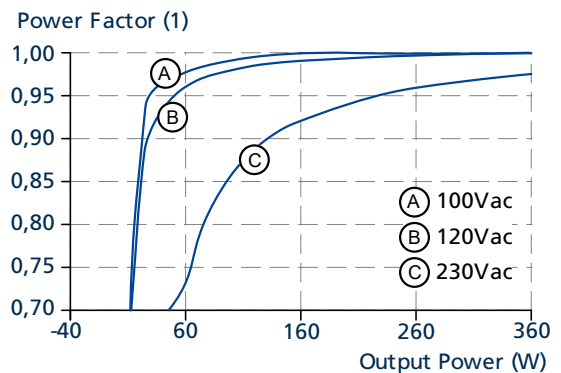

Fig. 3-4:
Power factor vs. output power at 24 V output voltage

All parameters are specified at 24 V, 12.5 A, 230 Vac, 25 °C ambient and after a 5 minutes run-in time unless otherwise noted.

4. DC-Input

The device is suitable to be supplied from a DC input voltage.

DC input*)	nom.	DC 110-300 V*)	±20 %
DC input range	min.	88 Vdc	
	max.	360 Vdc	
DC input current	typ.	2.90 A	At 110 Vdc, at 24 V, 300 W
	typ.	1.04 A	At 300 Vdc, at 24 V, 300 W
Turn-on voltage	Typ.	80 Vac	
Shut-down voltage	Typ.	70 Vac	

*) For DC supply voltage above 150Vdc an external fuse with an appropriate rating is required. Wide range DC input 110-300V without external fuse on request.

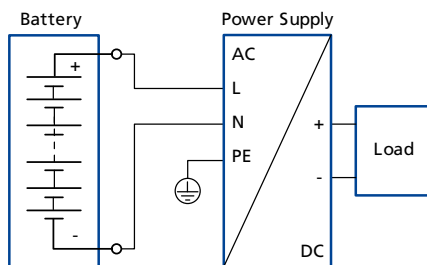

Fig. 4-1: Wiring for DC Input

Instructions for DC use:

- Use a battery or a similar DC source. A supply from the intermediate DC-bus of a frequency converter is not recommended and can cause a malfunction or damage the unit.
- Connect +pole to L and -pole to N.
- Connect the PE terminal to an earth wire or to the machine ground.

5. Input Inrush Current

An active inrush limitation circuit (NTCs, which are bypassed by a relay contact) limits the input inrush current after turn-on of the input voltage.

The charging current into EMI suppression capacitors is disregarded in the first microseconds after switch-on.

		AC 100 V	AC 120 V	AC 230 V
Inrush current	max.	2.18 A _{peak}	2.6 A _{peak}	6 A _{peak}

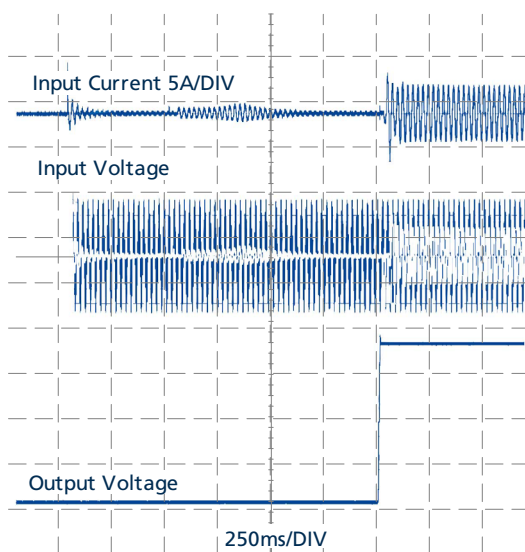

Fig. 5-1: Typical turn-on behavior at nominal load and 25 °C ambient temperature

All parameters are specified at 24 V, 12.5 A, 230 Vac, 25 °C ambient and after a 5 minutes run-in time unless otherwise noted.

6. Output

The outputs provide a (PELV/ES1) rated voltage, which is galvanically isolated from the input voltage. The negative potential of the outputs is permanently connected to PE within the unit. Do not connect any output to PE (Ground).

The device is designed to supply any kind of loads, including capacitive and inductive loads. If capacitors with a capacitance >20mF are connected to one output, this output might switch off after turning the unit or the output on or connecting the load.

All outputs are individually current limited. In case of an overload, the individual output switches off and needs to be reset manually with the reset button on the front of the device or via IO-Link. A cycling of the input power does not reset the output. The failure signals are stored until a reset is intentionally initiated.

For protection reasons a delay of at least 5 seconds is mandatory, before an output can be reset after it has been switched off. Otherwise the green LED will flicker after pushing the button. The unit is shipped with all outputs turned on. The ON/OFF function has no safety feature included.

The sum of the configured output power of all outputs may exceed the total output power of available power budget, see Fig. 6-2. If this is the case, the output with the highest number will tripped first followed by the next output to ensure that the lower channel number will supply continuous power and see no voltage dips.

Outputs start sequentially from 1 to 4 with an interval of 150ms, see Fig. 6-1.

Number of outputs		2	
Output voltage	Nom.	24 V	Factory setting 24.5 V
Adjustment range		24-28 V	Adjustable in steps: 24 V, 24.5 V, 25 V, 25.5 V, 26 V, 26.5 V, 27 V and 28 V
Factory setting	Typ.	24.5 V	±0.2 %, at nominal load
Line regulation	Max.	25 mV	Between 85 and 300 Vac input voltage change
Load regulation	Typ.	250 mV	Between 0 and 360 W output load, static value
Ripple and noise voltage	Max.	50 mVpp	Bandwidth 20 Hz to 20 MHz, 50 Ohm

Output current	Order number	Outputs	Connector	Max. current	Picture
	FPS300.245-016-101	2	2x 7/8" – 5pin	10 A each output	Fig. 6-3

Total output power	Nom.	360 W	Up to +45 °C at ambient temperatures, for the sum of all outputs.
	Nom.	300 W	At +55 °C at ambient temperatures, for the sum of all outputs.
	Nom.	150 W	At +70 °C at ambient temperatures, for the sum of all outputs.
	Nom.	600 W	Up to +55 °C at ambient temperatures, for the sum of all outputs.
short term up to 5s	Nom.	300 W	At +70 °C at ambient temperatures, for the sum of all outputs.
			Derate linearly between +55 °C and +70 °C
Overload behavior		Trip curve	See Fig. 6-3
Output capacitance	Typ.	12 500 µF	Included inside the power supply, common for all four outputs
Parallel Use			Do not parallel units for higher output currents
Back-feeding loads	Max.	35 V / 4 J	The unit is resistant and does not show a malfunction when a load feeds back voltage to the power supply. It does not matter whether the power supply is on or off. For all four outputs in total

All parameters are specified at 24 V, 12.5 A, 230 Vac, 25 °C ambient and after a 5 minutes run-in time unless otherwise noted.

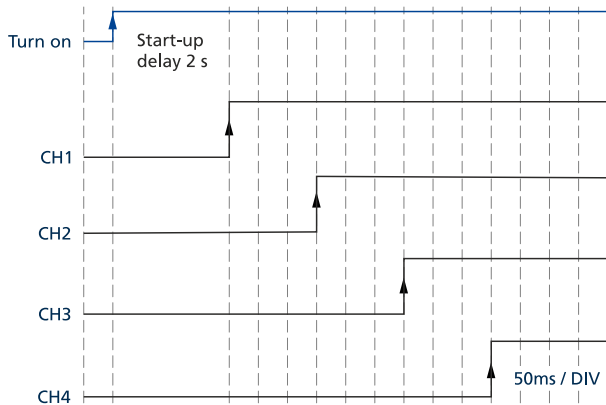

Fig. 6-1: Sequential start of the outputs

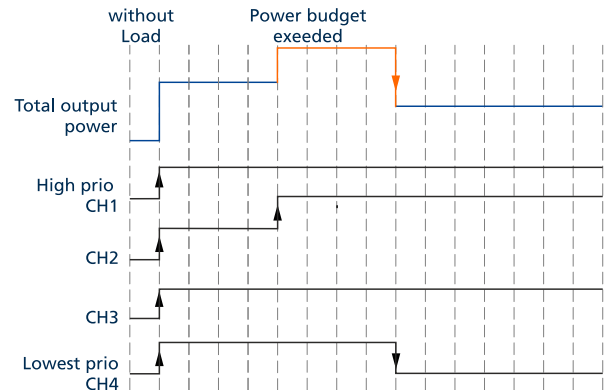

Fig. 6-2:
Tripping of the channel with the lowest priority when the power budget is exceeded

Time delay before switch off at overloads, typ. (s)

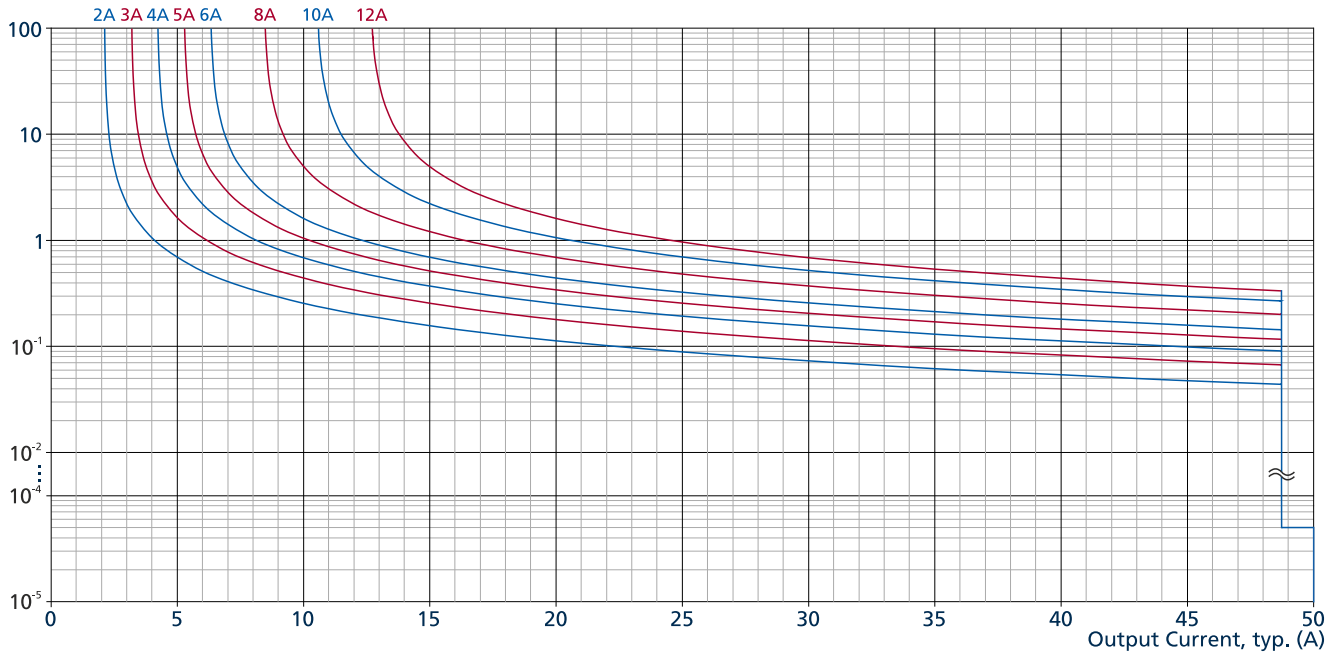

Fig. 6-3: Trip curve diagram

7. Hold-up Time

The hold-up time is the time during which a power supply's output voltage remains within specification following the loss of input power. The hold-up time is output load dependent. At no load, the hold-up time can be up to several seconds. The status LED is also on during this time.

		AC 100 V	AC 120 V	AC 230 V	
Hold-up Time	typ.	75 ms	75 ms	75 ms	At 150 W output load, see Fig. 7-1
	min.	56 ms	56 ms	56 ms	At 150 W output load, see Fig. 7-1
	typ.	44 ms	44 ms	44 ms	At 300 W output load, see Fig. 7-1
	min.	29 ms	29 ms	29 ms	At 300 W output load, see Fig. 7-1

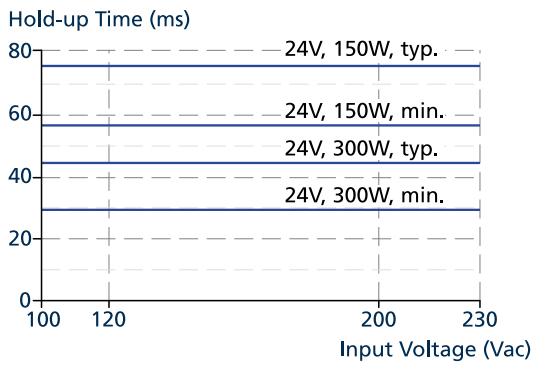

Fig. 7-1: Hold-up time vs. input voltage

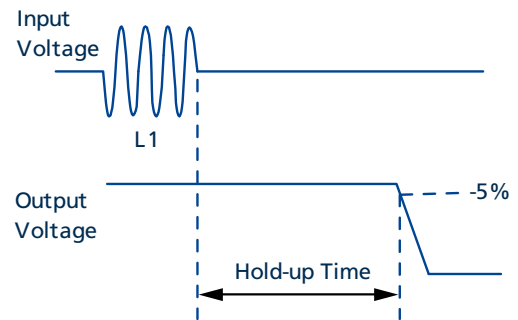

Fig. 7-2: Shut-down behavior, definitions

8. IO-Link Interface

The IO-Link interface used in this power supply is compliant to IO-Link protocol V1.1 and can be connected to any IO-Link masters compliant to V1.1 of the IO-Link protocol. This allows a transparent data flow to the sensors and actuators and therefore more transparent and easier way to monitor the current status of the power supply.

In case of no or defective connectivity of the IO-Link, the power supply can also be operated smoothly. Due to a built-in EEPROM, previously inputted data will be drawn from its storage.

To operate the IO-Link interface it is required to install/upload the IODD-File (IO-Link Device Description) into the connected IO-Link master. The most recent IODD file can be found on the PULS website (www.pulspower.com) in the download section of the individual product page. The device can also be accessed via IO-Link, if the power supply is not connected to AC-mains and in a switched off mode.

IO-Link Version	V1.1	To get full performance, it is recommended to use IO-Link
IO-Link master Version	V1.1	
Baud-Rate	COM3 (230.4 kBaud)	
Cycle Time	2ms	Cycle time refers to the reloading speed of certain process data Class B
SIO-Mode	yes	
Process Data Length	23 bytes	

The power supply provides three categories of data via IO-Link. They are divided between read only or read- and customizable data.

Control Settings

This set of data is customizable. The data in control settings can be adjusted to the user's preference to ensure an even better operation of the power supply. Typical control settings are e.g. setting tripping points, setting per-alarm levels, etc.

Parameter write	Value range	Description
Output Voltage Setpoint	24.0-28.0 V	Output Voltage Setpoint Pre-Setting- 24.5 V
Standby	0 - unit is operating 1 - unit in standby	PSU can be switched into standby, where all outputs turn off. Pre-Setting- 0=unit is operating
Configuration Setting	0 - human-machine interface only 1 - IO-Link only 2 - both 3 - none (button lock)	Controls the configurability of the PSU, which can be restricted to local HMI or IO-Link only. Configuration can also be blocked completely. Pre-Setting- 2=both
E-Fuse Channel on/off	0 – off 1 - on	Used to control the state of output channel switches (ON/OFF) or to reconnect a tripped channels. Bit coded parameter. Pre-Setting- 1=ON for all channels
E-Fuse trip value channel 1 to channel 4	1-10/12 A	Defines the output current threshold for each E-Fuse channel, where the electronic fuse is triggered. Pre-Setting- 10/12 A (depends on type of output connector)
E-Fuse Pre-alarm level channel 1 to channel 4	10-100 %	Defines the threshold for the event "Output current pre-alarm for each channel". Pre-Setting- 80 %
PSU total output current Pre-alarm level	1-100 A	Defines the threshold for the event "PSU output current pre-alarm". To suppress event generation, set this value to max (100 A). Pre-Setting- 20A

All parameters are specified at 24 V, 12.5 A, 230 Vac, 25 °C ambient and after a 5 minutes run-in time unless otherwise noted.

Parameter

The parameter values can be accessed to read out additional data (e.g. current output voltage, temperatures etc)

Parameter read	read out value range	Description
Output Voltage Setpoint	24.0-28.0 V	Output Voltage Setpoint Pre-Setting- 24.5 V
Standby	0 - unit is operating 1 - unit in standby	PSU can be switched into standby, where all outputs turn off. Pre-Setting- 0=unit is operating
Configuration Setting	0 - human-machine interface only 1 - IO-Link only 2 - both 3 - none (button lock)	Controls the configurability of the PSU, which can be restricted to local HMI or IO-Link only. Configuration can also be blocked completely. Pre-Setting- 2=both
E-Fuse Channel on/off	0 - off 1 - on	Used to control the state of output channel switches (ON/OFF) or to reconnect a tripped channels. Bit coded parameter. Pre-Setting- 1=ON for all channels
E-Fuse trip value channel 1 to channel 4	1-10/12 A	Defines the output current threshold for each E-Fuse channel, where the electronic fuse is triggered. Pre-Setting- 10/12 A (depends on type of output connector)
E-Fuse Pre-alarm level channel 1 to channel 4	10-100 %	Defines the threshold for the event "Output current pre-alarm for each channel". Pre-Setting- 80 %
PSU total output current Pre-alarm level	1-100 A	Defines the threshold for the event "PSU output current pre-alarm". To suppress event generation, set this value to max (100 A). Pre-Setting- 20 A
EEPROM Status	0 - OK 1 - Recoverable error detected 2 - Unrecoverable error	PSU internal EEPROM status information. If unrecoverable error is detected, the PSU may operate with pre-setting values.
PSU events	bit 0 - DC-OK bit 1 - DC-Warning bit 2 - Bonus Power bit 3 - Over Temperature CAP bit 4 - Over Temperature PSU bit 5 - Over load bit 6 - High voltage input bit 7 - Low voltage input bit 8 - Power supply down bit 9 - Predictive maintenance power supply bit 10 - 2 phase operation bit 12 - PSU settings changed via HMI bit 13 - PSU hardware failure	Collection of active events of the PSU. Bit-coded parameter, bits 11,14-15 not used.
Temperature secondary inside	-40-150 °C	Temperature at secondary DC output area inside PSU
Max. temperature secondary inside	-40-150 °C	Maximum temperature at secondary DC output area inside PSU
Temperature primary inside	-40-150 °C	Temperature at primary AC input area inside PSU
Max. temperature primary inside	-40-150 °C	Maximum temperature at primary AC input area inside PSU
AC Input Voltage RMS		Actual Input Voltage RMS (phase-phase)
Actual output voltage	0-49 V	Actual average output voltage

All parameters are specified at 24 V, 12.5 A, 230 Vac, 25 °C ambient and after a 5 minutes run-in time unless otherwise noted.

Parameter read	read out value range	Description
Actual output current	0-68 A	Actual average total output current
E-Fuse current channel 1 to channel 4	0-15 A	Actual average E-Fuse output current for each E-Fuse channel
E-Fuse output status	bit 0 - Ch1 bit 1 - Ch2 bit 2 - Ch3 bit 3 - Ch4 0 – off 1 - on	Actual state of E-Fuse output channels Bit coded parameter. 0 - channel is off 1 - channel is on
E-Fuse trip status channel 1 to channel 4	0 - No trip 1 - Over-load trip 2 - Short circuit trip 3 - Temperature trip 4 - Power budget trip 5 - Installation failure trip 6 - Sensor fault trip 7 - Fatal fault trip	Actual trip state of E-Fuse channel If the E-Fuse has tripped, this parameter gives detailed information about the reason. This information might help for failure analysis in the application.
Stress level	0 - "<5 %" 1 - ">5 %" 2 - ">25 %" 3 - ">50 %" 4 - ">75 %"	Stress level based on output power delivery. This parameter gives an indication about the total power consumption of the application and the remaining margin.
Remaining Endurance LED coded	0 - "<10 %" 1 - ">10 %" 2 - ">25 %" 3 - ">50 %" 4 - ">75 %"	This parameter gives an estimated remaining endurance indication. Overall performance of the PSU might decrease at low remaining endurance code.
Remaining Endurance	10-99 %	This parameter gives an estimated remaining endurance indication in percent. Overall performance of the PSU might decrease at low remaining endurance.

Counter

E-Fuse Number of Startups channel 1 to channel 4	0-150000	Counts the number of startups on each E-Fuse channel over the whole lifetime.
E-Fuse Number of Overcurrents channel 1 to channel 4	0-150000	Number of Overcurrents on each E-Fuse channel over the whole lifetime.
Operating time		
hours	0-1000000	Total operating hours
minutes	0-59	operating minutes
Transient VDE-0160 Counter overall	0-150000	Transient Counter overall
Transient VDE-0160 Counter last 2 minutes	0-65535	Transient Counter last 2 minutes
Turn-on Counter	0-150000	Turn-on Counter of the PSU
Uptime since last turn-on		
hours	0-1000000	Uptime since last turn-on – hours
minutes	0-59	Uptime since last turn-on - minutes

Device Status

Device Status	0 - Device is operating properly 1 - Maintenance-Required 2 - Out-of-Specification 3 - Functional-Check 4 - Failure	Overall PSU device state
Detailed Device Status	Octet Strings	Shows up to 5 pending events 3 octets per subindex- Octet 1 – EventQualifier Octet 2,3 - EventCode
Item [1]		
Item [2]		
Item [3]		
Item [4]		
Item [5]		

Event Data

This set of data is on read only. Event data reports on parameter errors and warns of device failures of the power supply to the IO-Link master. It is triggered when certain critical conditions or control settings are exceeded. Typical events are e.g. ambient temperature too hot, high input voltage, etc.

Events	Event-type	Description
Parameter error – Check data sheet and values	Error	
Device temperature over-run – Clear source of heat	Warning	
Events. DC-Warning	Warning	Output voltage dips more than 10% below adjusted output voltage
Events. Bonus Power	Notification	Output current is 5% more than maximum for more than 3s
Events. Over Load	Warning	Load higher than allowed
Events. High Voltage Input	Warning	Input to high
Events. Low Voltage Input	Warning	Input to low
Events. Power Supply down	Warning	No link from IO-Link Transceiver to Power Supply
Events. Predictive Maintenance Power Supply	Warning	The estimated remaining lifetime has reached 10%. Performance of PSU might be limited due to aging effects of components.
Events. Two phase AC supply	Warning	One leg of the 3-phase system is missing
Events. PSU setting changed via HMI	Warning	A PSU setting was changed via man-machine interface.
Events. PSU hardware failure	Warning	Critical PSU hardware failure detected. PSU shut down.
Events. PSU output current Pre-alarm	Warning	Total PSU output current exceeds pre-alarm limit
Events. E-Fuse channel 1 to channel 4 Tripped	Warning	For each E-Fuse channel when is tripped due to overcurrent
Events. Output current Pre-alarm channel 1 to channel 4	Notification	For each E-Fuse channel when Output current exceeds pre-alarm limit

Process Data

This set of data is on read only. Process data reports on the current state and conditions of the power supply to the IO-Link master. Typical process data are, e.g. actual output voltage of each output channel, internal temperatures, tripping status reports, etc.

Process	Value range	Description
Actual Output total Current	A	
Actual Output Voltage	V	Actual Output Voltage
E-Fuse Current channel 1 to channel 4	A	Actual Output Current from each E-Fuse Channel
E-Fuse channel states		Actual state of E-Fuse outputs (on/off)
E-Fuse overload trip states		Overload trip state of E-Fuse outputs (ok/tripped)
E-Fuse short circuit states		Short circuit trip state of E-Fuse outputs (ok/tripped)

For a full list of data set, see chapter 24, IO-Link Data Typs and Description.

9. Efficiency and Power Losses

		AC 100 V	AC 120 V	AC 230V	
Efficiency	typ.	93.6 %	94.3 %	95.7 %	At 24 V, 300 W
Average efficiency*)	typ.	92.9 %	93.5 %	94.6 %	25 % at 80 W, 25 % at 150 W, 25 % at 220 W, 25 % at 300 W
Power losses	typ.	2.7 W	2.8 W	2.2 W	At 24 V, 0 W (no load)
	typ.	10.7 W	10.0 W	8.3 W	At 24 V, 150 W (half load)
	typ.	20.5 W	18.1 W	13.5 W	At 24 V, 300 W (full load)

*) The average efficiency is an assumption for a typical application where the power supply is loaded with 25% of the nominal load for 25% of the time, 50% of the nominal load for another 25% of the time, 75% of the nominal load for another 25% of the time and with 100% of the nominal load for the rest of the time.

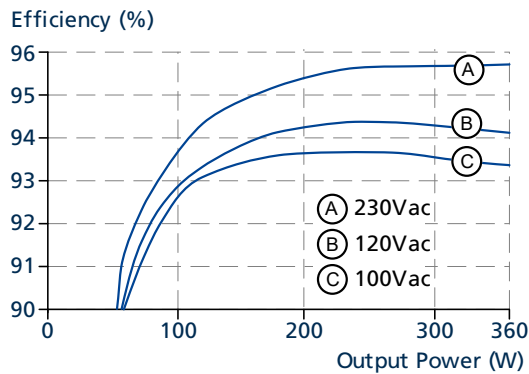

Fig. 9-1: Efficiency vs. output power at 24 V, typ.

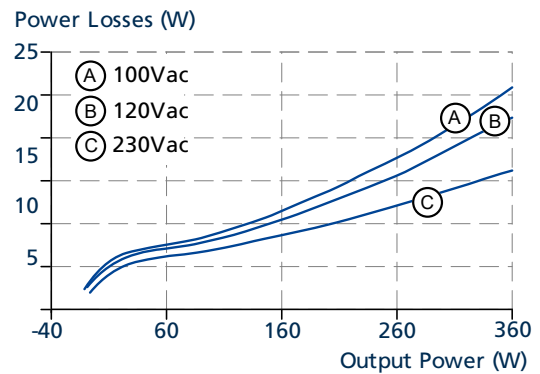

Fig. 9-2: Losses vs. output power at 24 V, typ.

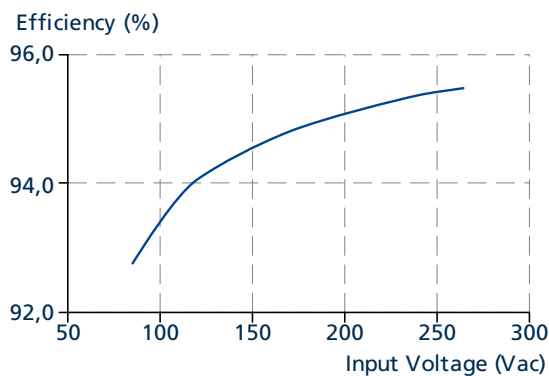

Fig. 9-3: Efficiency vs. input voltage at 24 V, 300 W, typ.

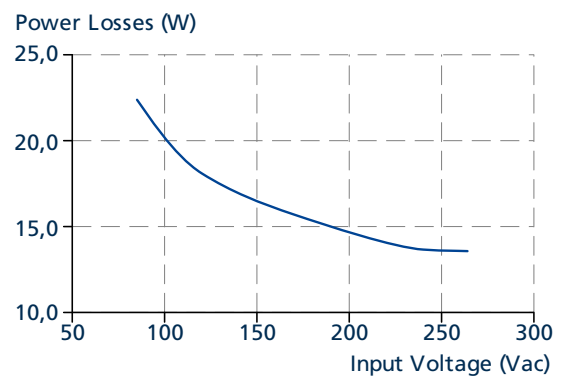

Fig. 9-4: Losses vs. input voltage at 24 V, 300 W, typ.

10. Lifetime Expectancy

The Lifetime expectancy shown in the table indicates the minimum operating hours (service life) and is determined by the lifetime expectancy of the built-in electrolytic capacitors. Lifetime expectancy is specified in operational hours and is calculated according to the capacitor's manufacturer specification.

The manufacturer of the electrolytic capacitors only guarantees a maximum life of up to 15 years (131 400 h). Any number exceeding this value is a calculated theoretical lifetime which can be used to compare devices.

	1AC 100 V	1AC 120 V	1AC 230 V	
Calculated lifetime expectancy	88 600 h	121 100 h	175 200 h	At 24V, 300 W and 40°C
	257 900 h	319 790 h	410 500 h	At 24V, 150 W and 40°C
	247 300 h	352 300 h	432 500 h	At 24V, 300 W and 25°C
	530 100 h	610 800 h	834 400 h	At 24V, 150 W and 25°C

11. MTBF

MTBF stands for **Mean Time Between Failure**, which is calculated according to statistical device failures, and indicates reliability of a device. It is the statistical representation of the likelihood of a unit to fail and does not necessarily represent the life of a product.

A MTBF figure of e.g. 1 000 000 h means that statistically one unit will fail every 100 hours if 10 000 units are installed in the field. However, it can not be determined if the failed unit has been running for 50 000 h or only for 100 h.

For these types of units the MTTF (**Mean Time To Failure**) value is the same value as the MTBF value.

	1AC 100 V	1AC 120 V	1AC 230 V	
MTBF SN 29500, IEC61709	270 000 h	305 000 h	384 000 h	At 24 V, 300 W and 40 °C
	489 000 h	546 000 h	679 000 h	At 24 V, 300 W and 25 °C
MTBF MIL HDBK 217F	106 000 h	118 000 h	135 000 h	At 24 V, 300 W and 40 °C; Ground Benign GB40
	160 000 h	175 000 h	195 000 h	At 24 V, 300 W and 25 °C; Ground Benign GB25
	29 000 h	32 000 h	35 000 h	At 24 V, 300 W and 40 °C; Ground Fixed GF40
	39 000 h	42 000 h	46 000 h	At 24 V, 300 W and 25 °C; Ground Fixed GF25

12. Functional Diagram

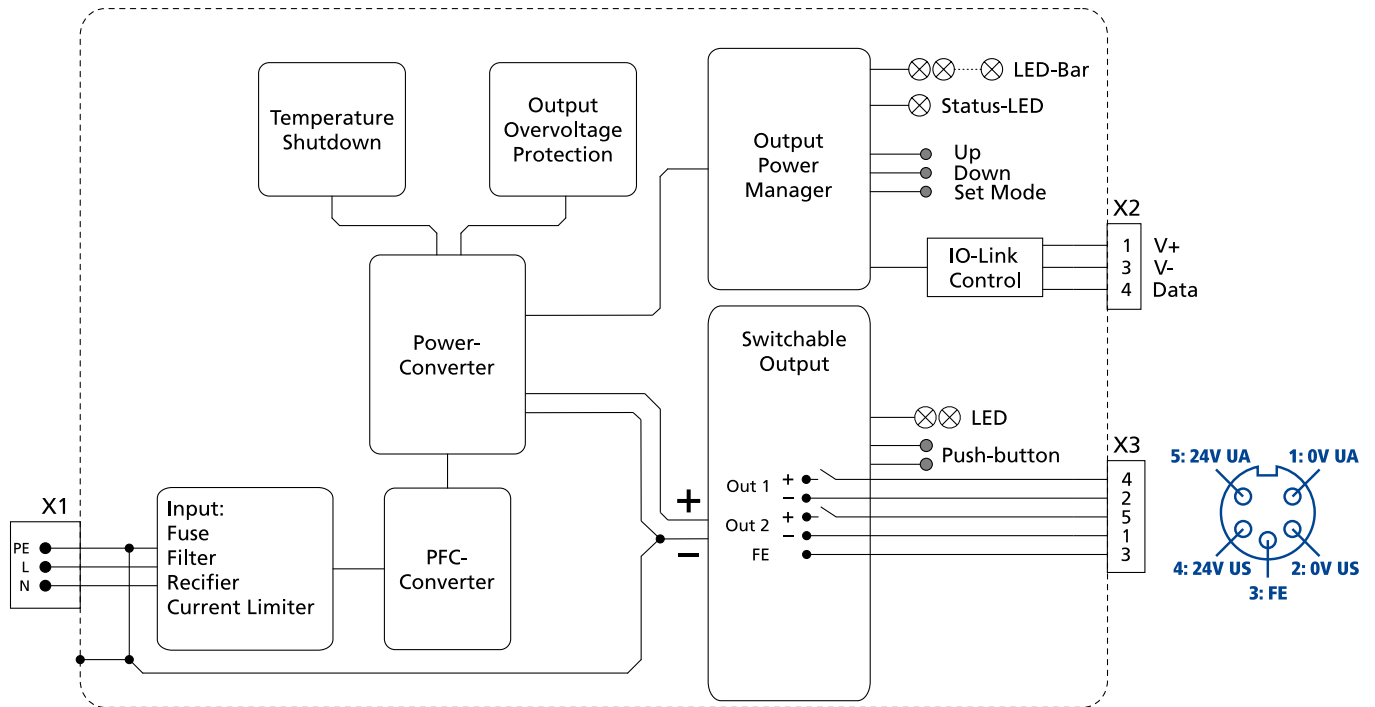
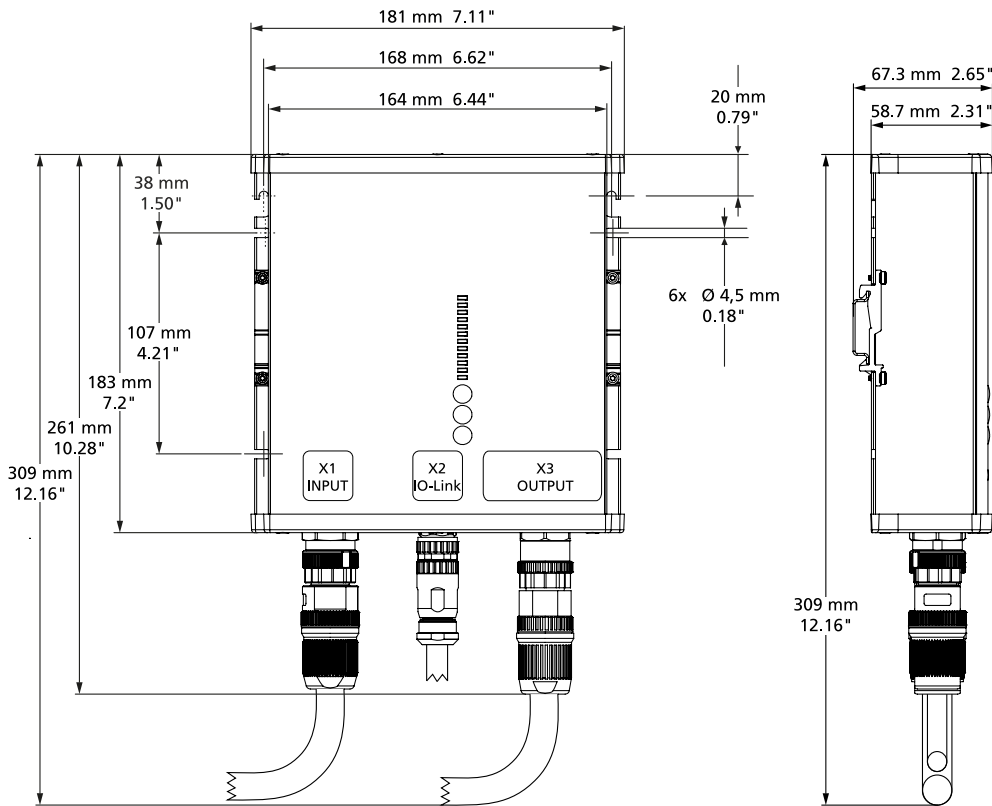

Fig. 12-1: Functional Diagram FPS300.245-016-101

13. Dimensions and Connector Variants

FPS300.245-016-101



Width 181 mm / 7.11"
 Height 183 mm / 7.2"
 Depth 59 mm / 2.32"
 Weight 1200 g / 2.7lb

Housing body material Aluminium alloy
 Housing cover material Hi-grade polycarbonate
 Installation clearances See chapter 2
 Mating connectors See chapter 21.3

Input connector on power supply (X1):

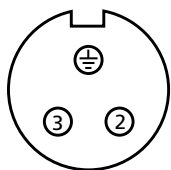

7/8" 3pin Male

Pin Ⓧ: PE connection
 Pin 2: L
 Pin 3: N

IO-Link connector on power supply (X2):

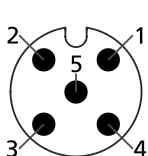

M12-A Male

Pin 1: 24 Vdc supply voltage
 Pin 2: not connected
 Pin 3: GND Supply voltage
 Pin 4: Data IN/OUT
 Pin 5: not connected

Output connector on power supply (X3 and X4):

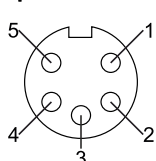

7/8" 5 pin Female

Pin 1: GND (Out 2) Ua Actor output
 Pin 2: GND (Out 1) Us Sensor output
 Pin 3: FE
 Pin 4: 24 Vdc (Out 1) Us Sensor output
 Pin 5: 24 Vdc (Out 2) Ua Actor output

All parameters are specified at 24 V, 12.5 A, 230 Vac, 25 °C ambient and after a 5 minutes run-in time unless otherwise noted.

14. User Interface

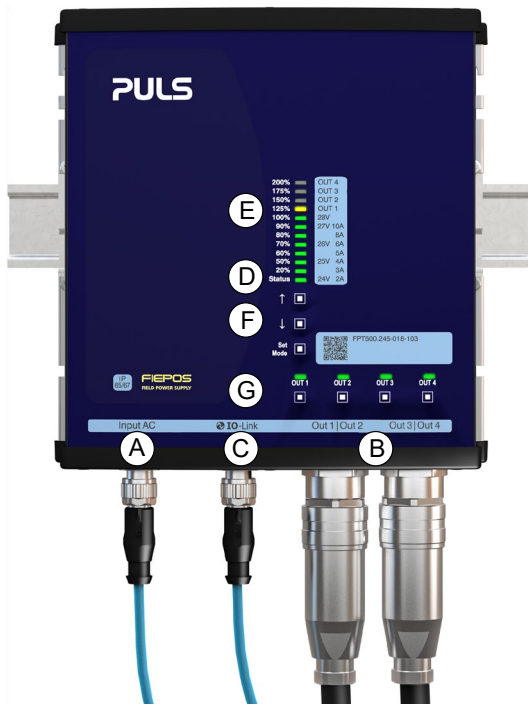

- A Input Connector
- B Output Connectors
- C IO-Link Connector
- D Status LED
- E LED Bar
- F Set Mode and Up and Down Button
- G Output LEDs ON/OFF & Reset Buttons

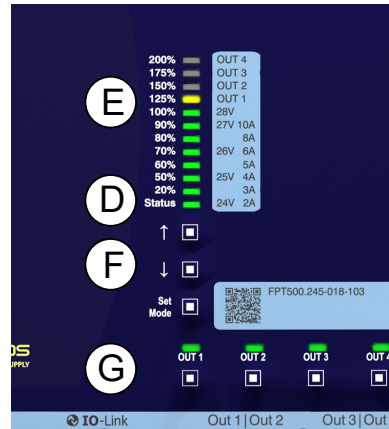

Overview

LED Bar (E)

The LED Bar is a multifunctional displaying tool. The main function is to monitor the sum of all outputs (percentages scale). It also can display the output voltage (voltage scale) and output current (ampere scale) for the individual outputs. The integrated Status LED displays different running conditions of the PSU in real-time.

Output Level Controls (F)

The Output Level Controls consist of the Set Mode button and the UP/DOWN buttons. The Set Mode is used to change into tripping current settings. The UP/DOWN are used to adjust different output levels or change into the Output Current Mode.

Output Controls (G)

The Output Controls consist of an output LED and an Output ON/OFF button (ON/OFF) for each output. The Output LED displays different running conditions for output in real-time. The ON/OFF is used to switch the output on/off.

Operation Settings

Monitor Output Power Mode

The Output Power Mode displays the actual total output power after startup. It is the default mode of the LED Bar. The output Power is Displayed in percentages of 300 W. E.g. If the LED Bar is powered up till 50 %, 150 W is expended. If the LED Bar rises above 100% and therefore exceeds 300 W the 125 %-LED flashes orange. Refer to the percentage scale on the left sidebar.

Monitor Output Current Mode

The Output Current Mode is to check the output current of the individual outputs.

To inspect these output currents:

- Press the UP or DOWN button. OUT1 in the LED bar lights up in orange. The output current is displayed in real-time in the LED Bar below. Refer to the ampere scale on the right sidebar.
- In the LED Bar switch between the OUT1 - OUT4 using the UP/DOWN buttons to check the different output current values.
- Return to the Output Power Mode/default mode by pushing beyond the highest (OUT4) or lowest (OUT1) output number.

All parameters are specified at 24 V, 12.5 A, 230 Vac, 25 °C ambient and after a 5 minutes run-in time unless otherwise noted.

Set Tripping Current

To set a new tripping current:

- Press Set Mode for 3 s. After all LEDs light up once, the LED now displays the set voltage.
- Press Set Mode to select the right output to change the tripping current. The orange LED will indicate which output is selected.
- Push UP/DOWN to increase or decrease the set point. Refer to the current scale on the right sidebar. (e.g. 20 %-LED indicates 3 A).
- New point is set.
- After 15 s of non-action, the PSU will automatically switch to Output Power Mode.

Set Output Voltage

To set a new output voltage:

- Press Set Mode for 3 s. After all LEDs light up once, the LED now displays the set voltage.
- Push UP/DOWN to increase or decrease the set point. Refer to the current scale on the right sidebar. (e.g. 20 %-LED indicates 24.5 V).
- New point is set.
- After 15 s of non-action, the PSU will automatically switch to Output Power Mode.

Set Button Lock

To activate/deactivate the button lock:

- Press the UP and DOWN buttons simultaneously for 3 s. The LED bar will flash for 5 s to indicate the changed button lock status.

Reset Output

In a failure mode where the output did/didn't switched OFF:

- Push and hold ON/OFF for more than 1s.

LED Signaling

Status LED (D)

The Status LED displays different running conditions of the PSU in real-time.



Green: On

DC voltage is above 90 % of set point voltage. All outputs are operating according to their settings.



OFF

DC voltage is below 90 % of set point voltage or an output channel has tripped or PSU is not powered.



Red: AC input failure

AC input drops below the specified levels and outputs turned off.



Flashes orange: Hiccup_{plus} mode!

Output is OFF during these 18s.



Flashes red: Overtemperature

The PSU turns OFF to prevent overheating. Normal operating range continues after the Status LED turns to solid green again.

Channel LED Signaling Overview

Below is an overview of the output LED signaling.

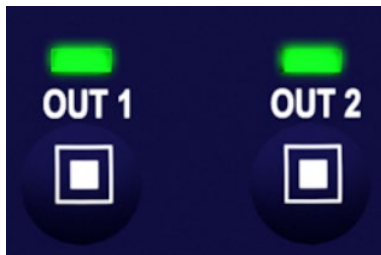













Fig. 14-1: Location of outputs LEDs

-  **OFF**
Output is switched OFF by ON/OFF or PSU is not powered (s. Status LED).
-  **Green: Default**
Output is switched on by ON/OFF.
-  **Flashes green: Power budget tripped** (slow rate: 250 ms ON / 250 ms OFF)
Low priority outputs are tripped. Sum of output currents are above PSU power budget.
-  **Flashes green: Buttons Locked** (fast rate: 125 ms ON / 125 ms OFF)
No action is carried out. Button lock feature activated. Unlock buttons by following Operation Settings > Set Button Lock. Other reason: MOSFET protection MOSFET is >90 °C or Interval between Charge Up/ Turn On cycles <5 s.
-  **Orange: Pre-Alarm!**
Output is still running. Current is above pre-alarm level and close to overload.
-  **Flashes orange: Overload!** (slow rate: 500 ms ON / 500 ms OFF)
Output is tripped. Output current is overloaded. Restart by pushing the ON/OFF.
-  **Flashes orange: Faulty Installation** (medium rate: 250 ms ON / 250 ms OFF)
Output is turned OFF automatically. Cable or connected hardware on the outputs are not installed correctly. Switch OFF the output manually by pushing the specific output ON/OFF button.
 - PSU with NEC Class II outputs: Difference between positive and negative/Input-Output current of the output are >1 A for 6-6.5 s
 - PSU without NEC Class II outputs: Connector negative wire overcurrent according to negative trip curve, or output was contributing to negative overcurrent of another output ($I_{pos} - I_{neg} > \text{threshold}$), or High PE current (>12 A) was detected based on overall output current sum.
-  **Flashes orange: Short Circuit** (fast rate: 125 ms ON / 125 ms OFF)
Output is tripped. The Output's output current exceeded approx. 48A. Short circuit reasons may be electrical short, loads beyond specification, plugging-in a large capacitance during operation, etc. After pushing of specific output ON/OFF button, e-fuse output tries to turn ON.
-  **Flashes Orange/Green: Overtemperature!** (slow rate, 250 ms orange / 250 ms)
Output will automatically turned OFF when MOSFET overtemperature (125 °C) is reached. When MOSFET temperature falls below 90 °C the output will turn on automatically.
-  **Red: Fatal MOSFET Malfunction!**
PSU turns OFF. Power switch on specific output is damaged. Replacement of PSU might be required.
Possible malfunction:
 - Positive current output in OFF state exceeds >2 A for more than >0.5 s
-  **Flashes red: Hardware Specs Out of Range!** (slow rate, 500 ms ON / 500 ms OFF)
Affected output channel turns OFF. Measurement Circuit Hardware is out of specified range. Replacement of PSU might be required.

Possible malfunction:
 - Deviations of internal output current sensors exceed acceptable limits.
 - Temperature sensor measurement out of range (-40 °C or +150 °C) for more than 5 s

All parameters are specified at 24 V, 12.5 A, 230 Vac, 25 °C ambient and after a 5 minutes run-in time unless otherwise noted.

15. EMC

The EMC behavior of the device is designed for applications in industrial environment as well as in residential, commercial and light industry environments.

The device is investigated according to EN 61000-6-1, EN 61000-6-2, EN 61000-6-3, EN 61000-6-4, EN 61000-3-2 and EN 61000-3-3.

EMC immunity

Electrostatic discharge	EN 61000-4-2	Contact discharge	8 kV	Criterion A
Air discharge		Air discharge	15 kV	Criterion A
Electromagnetic RF field	EN 61000-4-3	80 MHz - 2.7 GHz	20 V/m	Criterion A
		2.7 GHz – 6 GHz	10 V/m	Criterion A
Magnetic field	EN 61000-4-8	50 Hz/60 Hz	30 A/m	Criterion A
Fast transients (Burst)	EN 61000-4-4	AC Input lines	4 kV	Criterion A
		DC Output lines	4 kV	Criterion A
		IO-Link	4 kV	Criterion A
Surge voltage on AC input	EN 61000-4-5	L to N	2 kV	Criterion A
		L to PE, N to PE	4 kV	Criterion A
Surge voltage on DC output	EN 61000-4-5	+ to -	1 kV	Criterion A
		+/- to PE	2 kV	Criterion A
Surge voltage on IO-Link	EN 61000-4-5	IO-Link to PE	1 kV	Criterion A
Conducted immunity	EN 61000-4-6	0.15 – 80 MHz	20 V	Criterion A
Voltage dips	EN 61000-4-11	0 % of 100 Vac	0 Vac, 20 ms	Criterion A
		40 % of 100 Vac	40 Vac, 200 ms	Criterion C
		70 % of 100 Vac	70 Vac, 500 ms	Criterion C
		0 % of 200 Vac	0 Vac, 20 ms	Criterion A
		40 % of 200 Vac	80 Vac, 200 ms	Criterion A
		70 % of 200 Vac	140 Vac, 500 ms	Criterion A
Voltage interruptions	EN 61000-4-11	0 V	5000 ms	Criterion C
Voltage sags	SEMI F47	Dips on the input voltage according to SEMI F47 standard		
		80 % of 120 Vac (96 Vac)	1000 ms	Criterion A
		70 % of 120 Vac (84 Vac)	500 ms	Criterion A
		50 % of 120 Vac (60 Vac)	200 ms	Criterion A
Powerful transients	VDE 0160	Over entire load range	750 V, 0.3 ms	Criterion A

Performance criterions:

A: The device shows normal operation behavior within the defined limits.

C: Temporary loss of function is possible. The device may shut-down and restarts by itself. No damage or hazards for the device will occur.

***)** For IO Link certification immunity test levels according EN 61326-1:2013-01 have been tested

EMC Emission

Conducted emission AC input lines	EN 55011, EN 55015, EN 55032, FCC Part 15, CISPR 11, CISPR 32	Class B
Conducted emission DC output lines	IEC/CISPR 16-1-2, IEC/CISPR 16-2-1	
Conducted emission IO-Link output		
Radiated emission	EN 55032 / EN 55011	Class B
Harmonics	EN 61000-3-2	Class A fulfilled between 0A and 12A load
Voltage fluctuations, flicker	EN 61000-3-3	Pass tested with constant current loads, non pulsing

This device complies with FCC Part 15 rules.

Operation is subjected to following two conditions: (1) this device may not cause harmful interference, and (2) this device must accept any interference received, including interference that may cause undesired operation.

Switching Frequencies

PFC converter	20 kHz to 135 kHz	Input voltage and output load dependent
Main converter	60 kHz to 140 kHz	Output load dependent
Auxiliary converter	54 kHz to 66 kHz	Output load dependent
Microcontroller clocks	48 Mhz and 32 MHz	Fixed frequency

16. Environment

Operational temperature	-25 °C to +70 °C (-13 °F to 158 °F)	Operational temperature is the same as the ambient or surrounding temperature and is defined as the air temperature 2cm below the unit.
Storage temperature	-40 °C to +85 °C (-40 °F to 185 °F)	For storage and transportation
Output derating	6 W/°C 10 W/°C 20 W/1000 m or 5°C/1000 m	Between +45 °C and +55 °C (113 °F to 131 °F) Between +55 °C and +70 °C (131 °F to 140 °F) For altitudes >2000 m (6560 ft), see Fig. 16 2: Output power vs. altitude The derating is not hardware controlled. The user has to take care to stay below the derated current limits in order not to overload the unit.
Humidity	5 to 95 % r.h.	According to IEC 60068-2-30
Atmospheric pressure	54-110k Pa	see Fig. 16-2: Output power vs. for details
Altitude	Up to 5000 m (16 400 ft)	see Fig. 16-2: Output power vs. for details
Over-voltage category	III II	According to IEC 60664-1 For TN, TT mains systems with earthed neutral and IT star mains systems with insulation monitoring for altitudes up to 2000 m According to IEC 60664-1 For TN, TT mains systems with earthed neutral and IT star mains systems with insulation monitoring for altitudes between 2000 m and 5000 m According to IEC 60664-1 For TN, TT, IT Delta mains systems or IT star mains systems without insulation monitoring for altitudes up to 2000 m
Degree of pollution	3	According to IEC 62477-1, not conductive
Vibration sinusoidal	2-17.8 Hz: ±1.6 mm; 17.8-500 Hz: 2 g 2 hours / axis	According to IEC 60068-2-6
Shock	30 g 6 ms, 20 g 11 ms 3 bumps / direction, 18 bumps in total Shock and vibration is tested in combination with DIN-Rails according to EN 60715 with a height of 15 mm and a thickness of 1.3 mm and standard orientation.	According to IEC 60068-2-27
LABS compatibility	Yes	
Audible noise	Some audible noise may be emitted from the power supply during no load, overload or short circuit.	

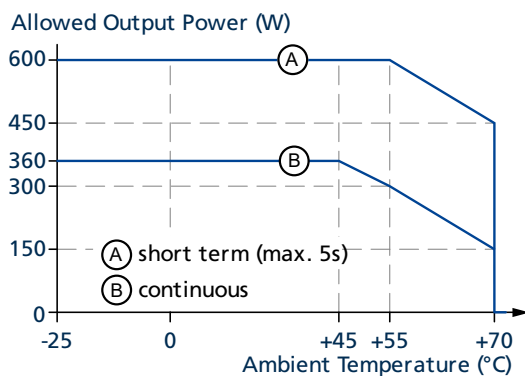

Fig. 16-1: Output power vs. ambient temp.

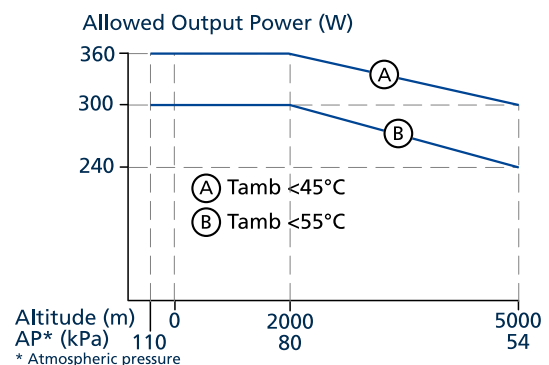

Fig. 16-2: Output power vs. altitude

All parameters are specified at 24 V, 12.5 A, 230 Vac, 25 °C ambient and after a 5 minutes run-in time unless otherwise noted.

17. Safety and Protection Features

Isolation resistance	min.	500 MOhm	At delivered condition between input and output, measured with 500 Vdc
	min.	500 MOhm	At delivered condition between input and PE, measured with 500 Vdc
PE resistance	max.	0.1 Ohm	Resistance between PE terminal and the housing
Input/Output separation		PELV	IEC/EN/UL 61010-2-201, IEC/EN 62368-1, IEC/EN 60950-1
Output over-voltage protection	typ.	31.8 Vdc	In case of an internal defect, a redundant circuit limits the maximum output voltage. The output shuts down and automatically attempts to restart
	max.	32.5 Vdc	
Class of protection			According to IEC 61140 A PE (Protective Earth) connection is required
Ingress protection		IP 65/67	According to EN/IEC 60529
Over-temperature protection		Included	Output shut down with automatic restart. Temperature sensors are installed on critical components inside the unit and turns the unit off in safety critical situations, which can happen e.g. when ambient temperature is too high, ventilation is obstructed or the de-rating requirements are not followed. There is no correlation between the operating temperature and turn-off temperature since this is dependent on input voltage, load and installation methods.
Input transient protection		MOV (Metal Oxide Varistor)	For protection values, see chapter 23, EMC.
Internal input fuse		Included	Not user replaceable slow-blow high-breaking capacity fuse
Touch current (leakage current)	max.	0.51 mA _{rms}	At 264Vac, 60Hz

18. Dielectric Strength

The negative terminal of the outputs is permanently connected to PE within the unit. The output is insulated from the input by a double or reinforced insulation.

Type and routine tests are conducted by the manufacturer. Field tests may be conducted in the field using the appropriate test equipment which applies the voltage with a slow ramp (2s up and 2s down). Connect all input-terminals before conducting the test. When testing, set the cut-off current settings to the value in the table below.

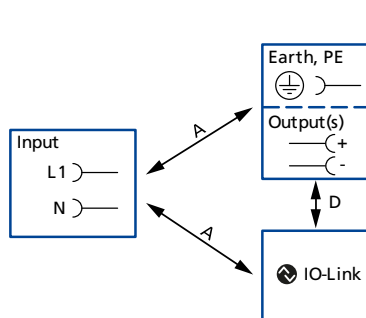



Fig. 18-1: Dielectric strength

		A	D
Type test	60 s	2500 Vac	500 Vac
Routine test	5 s	2500 Vac	500 Vac
Field test	5 s	2000 Vac	500 Vac
Cut-off current setting for field test		>10 mA	>10 mA

19. Approvals and Fulfilled Standards

IEC 62368	CB Report	CB Scheme Certificate IEC 62368-1 - Audio/video, information and communication technology equipment - Safety requirements Output safety level: ES1
IEC 61010	Safety ✓	CB Scheme Certificate IEC 61010-2-201 - Electrical Equipment for Measurement, Control and Laboratory Use - Particular requirements for control equipment
IEC 60950	CB Report	Manufacturers Declaration IEC 60950-1 - General safety requirements for Information Technology Equipment (ITE)
UL 61010		UL Certificate Listed equipment for category NMTR - UL 61010-2-201 - Electrical equipment for measurement, control and laboratory use - Particular requirements for control equipment Applicable for US and Canada E-File: E198865
Semi F47	SEMI F47	Test Report Voltage Sag Immunity for Semiconductor Processing Equipment Tested for AC 208V L-L or L-N mains voltages, nominal output voltage and nominal output load
VDMA 24364	LABS VDMA 24364-C1-L/W	Paint Wetting Impairment Substances Test (or LABS-Test) Tested for Zone 2 and test class C1 according to VDMA 24364-C1-L/W for solvents and water-based paints

20. Regulatory Compliance

EU Declaration of Conformity		Trade conformity assessment for Europe The CE mark indicates conformance with the European - EMC directive - Low-voltage directive (LVD) - RoHS directive
WEEE Directive		Manufacturer's Statement EU-Directive on Waste Electrical and Electronic Equipment (WEEE) registered in Germany as business to business (B2B) products. WEEE-Reg.-Nr. DE 55837529
REACH Regulation (EU)		Manufacturer's Statement EU regulation regarding the Registration, Evaluation, Authorization and Restriction of Chemicals (REACH) fulfilled.
China RoHS		Manufacturer's Statement The device meets the Measures for Restriction of the Use of Hazardous Substances in Electrical & Electronic Products according the China-RoHS requirements. The device is marked with EFUP symbol 25 years (Environmentally Friendly Use Period)
IEC/EN 61558-2-16 (Annex BB)	Safety Isolating Transformer	Safety Isolating Transformers corresponding to Part 2-6 of the IEC/EN 61558

21. Accessories

21.1. DIN RAIL Mounting KIT: ZM.FPDRA-11

In addition to screw mounting FIEPOS can easily be attached to a DIN rail using the ZM.FPDRA-11 DIN rail mounting kit.

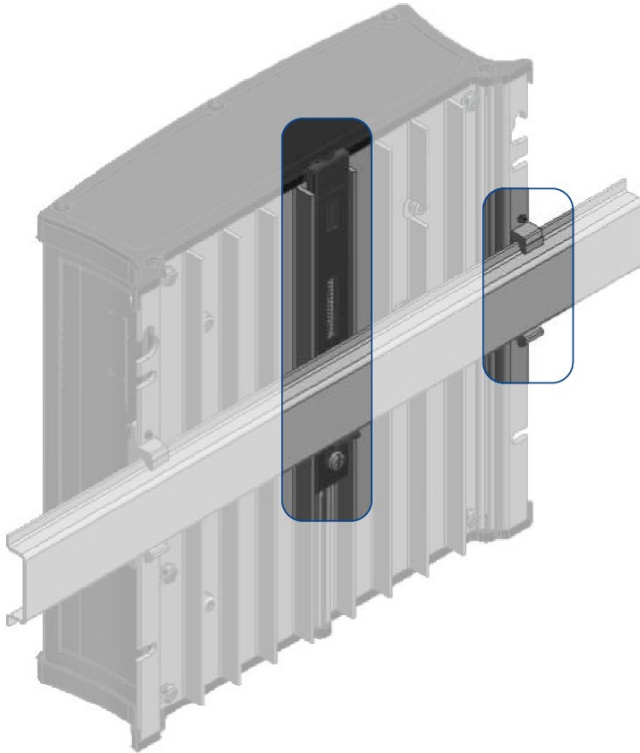

- DIN-Rail not included
- DIN-Fixture pre-assembled

21.2. Mounting Bracket: ZM.FPMBA-11

In addition to screw mounting FIEPOS can easily be attached to a mounting bracket the ZM.FPMBA-11.

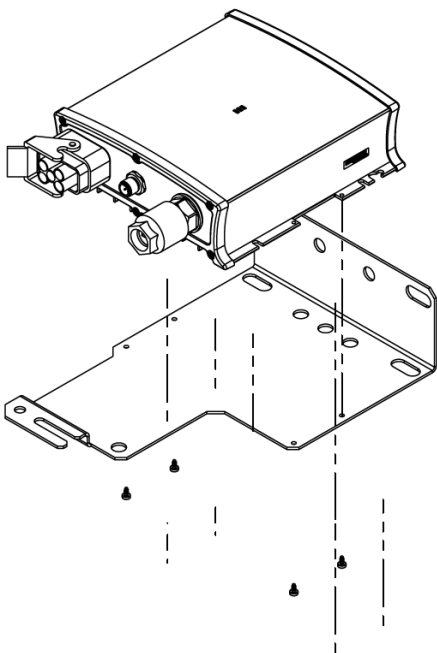

21.3. Connectors

FIEPOS features a large number of different connectors. Mating connectors can be ordered at PULS from stock in order to supply customers quickly during the design-in phase.

For a higher demand or other connector options go to [HARTING-PULS-cabling](#).

Connector Name	PULS order code	Harting order code	Connector Description
Harting HANQ4/2	ZCF.hanq42	6104401263700	Q4/2 Set AS female 2.5-6mm ² 7-13mm
Harting HANQ4/2	ZCF.hanq42-1	6104401263800	Q4/2 Set AS female 2.5-6mm ² 14-17mm
Harting HANQ2/0	ZCM.hanq20	6104401263900	Q2/0 Set screw male 2.5-6mm ² 6-12mm
Harting HANQ4/0	ZCM.hanq40	6104401265100	Q4/0 Set crimp 2,5mm ² IP67
Harting HANQ5/0	ZCF.hanq50	6104401265000	Q5/0 Set QuickLock female 0.5-2.5mm ² 6-12mm
Harting M12-A	ZCF.m12a5p	21032722505	M12-A 5pin cut clamp female 0.34-0.5mm ² / 6-8mm
Harting M12-A	ZCM.m12a5p	21032721505	M12-A 5pin cut clamp male 0.34-0.5mm ² / 6-8mm
Harting M12-S	ZCF.m12s4p	6102201020400	M12-S 4pin screw female 2.5mm ² / 6-8mm
Harting M12-L	ZCM.m12l5p	21032961505	M12-L 5pin cut clamp male 0.75-1.5mm ² / 5.8-13.5mm
Harting M12-T	ZCM.m12t4p	6102201021000	M12-T 4pin screw male 1.5mm ² / 8-10mm
Harting 7/8"	ZCM.78inch4p	6102201021100	7/8" 4pin screw male 1.5mm ² / 6-8mm
Harting 7/8"	ZCF.78inch3p	6102201021200	7/8" 3pin screw female 1.5mm ² / 6-8mm
Harting 7/8"	ZCM.78inch5p	21041162505	7/8" 5pin screw male 0.75-1.5mm ² / 6.8-12.5mm

22. Related Products

The FIEPOS product family includes various devices with different technical parameters and features. The following page provides a general overview of the available solutions. Please also get in touch with your PULS contact person, for more detailed application advice and technical information.

FPS300.245-049-102:

Power Supply with three **fused channels** (2–10A) and Output-OK contact.



SHORT-FORM DATA

Input voltage	1AC 100-240 V	-15 / +10%
Output voltage	DC 24V	Nominal
Adjustment range	24-28Vdc	Factory setting 24.5V
Output power	Continuous:	
	360W	Up to +45°C ambient
	300W	At +55°C ambient
	150W	At +70°C ambient
	Short-term, up to 5s:	
	600W	Below +55°C ambient
	300W	At +70°C ambient
	Derate linearly between +55 °C to +70 °C	
Number of outputs	3	
Output current	Settable per output; up to 10A	
Input connector	7/8" 3pin	
Output connector	7/8" 4pin	

FPT500.246-049-102:

Power Supply with three **NEC CLASS II** channels and IO-Link.



SHORT-FORM DATA

Input voltage	1AC 100-240 V	-15 / +10%
Output voltage	DC 24V	Nominal
Adjustment range	24-28Vdc	Factory setting 24.5V
Output power	Continuous:	
	360W	Up to +45°C ambient
	300W	At +55°C ambient
	150W	At +70°C ambient
	Short-term, up to 5s:	
	600W	Below +55°C ambient
	300W	At +70°C ambient
	Derate linearly between +55 °C to +70 °C	
Number of outputs	3	
Output current	NEC Class II	
Input connector	7/8" 3pin	
Output connector	7/8" 4pin	

All parameters are specified at 24 V, 12.5 A, 230 Vac, 25 °C ambient and after a 5 minutes run-in time unless otherwise noted.

23. Application Notes

23.1. Repetitive Pulse Loading

Typically, a load current is not constant and varies over time. This power supply is designed to support loads with a higher short-term power demand (BonusPower). The short-term duration is hardware controlled by an output power manager and is available on a repeated basis. If the average load is higher than the sum of all output power, the output voltage will dip.

To avoid this, the following rules must be followed:

- a) The power demand of the pulse must be below 200% of the nominal output power.
- b) The duration of the pulse power must be shorter than the allowed BonusPower time, see chapter 6
- c) The average power should be lower than the nominal output power.

The R.M.S. output current must be below the specified continuous output current. If the R.M.S. current is higher, the unit may respond with a thermal shut-down after a period of time.

23.2. External Input Protection

The device is designed, tested and approved for branch circuits up to 20 A (UL) and 32 A (IEC) without additional protection device. If an external fuse is utilized, do not use circuit breakers smaller than 6 A B- or C-Characteristic to avoid a nuisance trip.

23.3. Inductive and Capacitive Loads

The unit is designed to supply any kind of loads, including capacitive and inductive loads. If extreme large capacitors, such as EDLCs (electric double layer capacitors or "UltraCaps") with a capacitance larger than 20mF are connected to the output, the unit might charge the capacitor or the output might trip, chapter 6.

23.4. Back Feeding Loads

Loads such as decelerating motors and inductors can feed voltage back to the power supply. This feature is also called return voltage immunity or resistance against Back- E.M.F. (Electro Magnetic Force).

This power supply is resistant and does not show malfunctioning when a load feeds back voltage to the power supply. It does not matter whether the power supply is on or off.

23.5. Mounting Orientations

The device can be mounted in various mounting orientations. The listed lifetime and MTBF values from this datasheet apply only for the standard mounting orientation. The following curves give an indication for allowed output power in different mounting orientations for altitudes up to 2000 m (6560 ft).

A

Standard Orientation

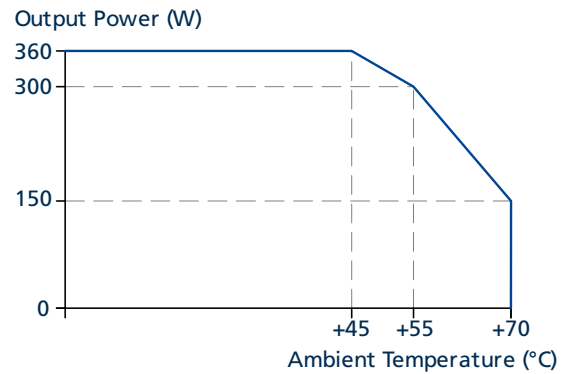
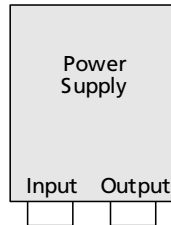

B

Upside down

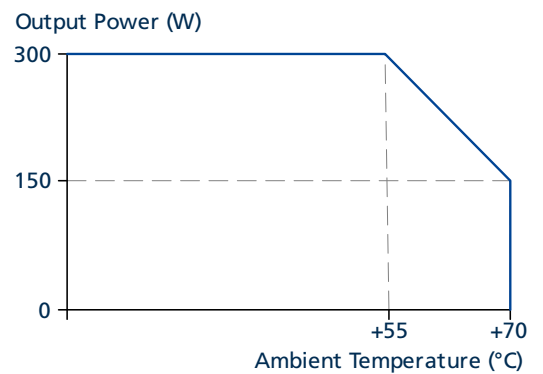
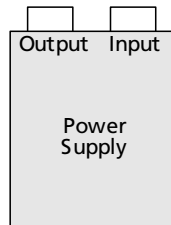

C

Horizontal
cw and ccw



D

Over-head and
Table-top mounting

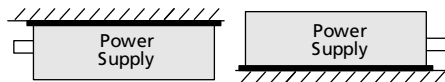

24. IO-Link Data Types and Description

24.1. Cyclic Data

The first dataset is called process data and refers to data that is periodically sent to the IO-Link master. The data is updated and communicated every 2ms. All other data in the power supply itself is generated every 50ms and stored in the IO-Link registers. The higher cycle frequency enables operation with IO-Link masters and attached PLCs without configuration.

Process	Sub-index	Bit offset	Data type	Bit length	Data Format	Resolution	Allowed values
Actual Output total Current	1	72	uint16_t	16	Q8.8	2 ⁻⁸ A/bit	
Actual Output Voltage	2	56	uint16_t	16	Q8.8	2 ⁻⁸ A/bit	
E-Fuse Current CH1	3	40	uint16_t	16	Q8.8	2 ⁻⁸ A/bit	
E-Fuse Current CH2	4	24	uint16_t	16	Q8.8	2 ⁻⁸ A/bit	
E-Fuse CH1 state	8	16	bool	1	-	-	true = On
E-Fuse CH2 state	9	17	bool	1	-	-	false = Off
E-Fuse CH1 overload trip state	16	8	bool	1	-	-	true = tripped
E-Fuse CH2 overload trip state	17	9	bool	1	-	-	false = Ok
E-Fuse CH1 short circuit state	20	0	bool	1	-	-	true = tripped
E-Fuse CH2 short circuit state	21	1	bool	1	-	-	false = Ok

All parameters are specified at 24 V, 12.5 A, 230 Vac, 25 °C ambient and after a 5 minutes run-in time unless otherwise noted.

Octet	0	1	2	3	4	5	6	7
Subindex	1	1	2	2	3	3	4	4
Bit offset	119-112	111-104	103-96	95-88	87-80	79-72	71-64	63-56
Octet 8								
Subindex	-	-	-	-	-	-	9	8
Bit offset	23	22	21	20	19	18	17	16
Octet 9								
Subindex	-	-	-	-	-	-	17	16
Bit offset	15	14	13	12	11	10	9	8
Octet 10								
Subindex	-	-	-	-	-	-	21	20
Bit offset	7	6	5	4	3	2	1	0

All parameters are specified at 24 V, 12.5 A, 230 Vac, 25 °C ambient and after a 5 minutes run-in time unless otherwise noted.

24.2. Acyclic data

The parameter values can be accessed to read out additional data (e.g. current output voltage, temperatures etc.), but in addition some of these values can also be written by the user to configure the power supply (e.g. output voltage and remote on/off).

Parameter	Para. Index	Sub-index	Data type	Bit offset	Data Format	Resolution	Default values	Read [R] Write [W]	Allowed values	Description
Output Voltage Setpoint	105	0	uint16	15-0	Q8.8	2 ⁻⁸ V/bit	6272 (24.5V)	R/W	6144...7168	Output Voltage Setpoint Minimum value is 24.0V Maximum value is 28.0V
Standby	101	0	bool				0	R/W	0 = PSU normal operation (default value) 1 = PSU standby	Dynamic, excluded from data storage
Configuration Setting	103	0	uint8	7-0			2	R/W	0 = human-machine interface only 1 = IO-Link only 2 = both (default value) 3 = none (button lock)	Dynamic
E-Fuse Channel on/off Chanel 1 Chanel 2	106	0	bool array 8-bit Record	0 1			1	R/W	0 = off 1 = on	Dynamic bit 2...7 not used Access via subindex 0 only
E-Fuse trip value all CH		0	uint16 array	31-0	Q8.8	2 ⁻⁸ A/bit	max	R	256...2560 at 10A 256...3072 at 12A	Dynamic Default is max. current available
E-Fuse trip value CH1	108	1	uint16	31-16	Q8.8	2 ⁻⁸ A/bit	max	R	256...2560 at 10A 256...3072 at 12A	
E-Fuse trip value CH2		2	uint16	15-0	Q8.8	2 ⁻⁸ A/bit	max	R	256...2560 at 10A 256...3072 at 12A	
E-Fuse Pre-alarm level all CHs		0	uint8 array	15-0	Q9.7	2 ⁻⁷ /bit	103 (80%)	R/W	13...192 (10% -150%)	Dynamic
E-Fuse Pre-alarm level CH1	109	1	uint8	15-8	Q9.7	2 ⁻⁷ /bit	103 (80%)	R/W	13...192 (10% -150%)	
E-Fuse Pre-alarm level CH2		2	uint8	7-0	Q9.7	2 ⁻⁷ /bit	103 (80%)	R/W	13...192 (10% -150%)	
PSU total output current Pre-alarm level	104	0	uint16	15-0	Q8.8	2 ⁻⁸ A/bit	5120 (20A)	R/W	256...25600 (1A-100A)	Dynamic
EEPROM Status	64	0	uint8	7-0				R	0 = ok 1 = recoverable error detected 2 = unrecoverable error	Dynamic

All parameters are specified at 24 V, 12.5 A, 230 Vac, 25 °C ambient and after a 5 minutes run-in time unless otherwise noted.

Parameter	Para. Index	Sub-index	Bit offset	Data type	Bit length	Read [R] Write [W]	Description
PSU events	65			uint16	16	R	dynamic
Output-OK		1	0	bool		R	bit 0...Output Voltage >90% of adjusted output voltage
DC-Warning		2	1	bool		R	bit 1... Output voltage dips more than 10% below adjusted output voltage
Bonus Power		3	2	bool		R	bit 2... Output current is 5% more than maximum for more than 3s
Over Temperature CAP		4	3	bool		R	bit 3...Temperature Capacitor is higher than 95°C
Over Temperature PSU		5	4	bool		R	bit 4... Temperature of PSU is higher than 95°C
Over Load		6	5	bool		R	bit 5... Load higher than allowed
High Voltage Input		7	6	bool		R	bit 6... Input to high
Low Voltage Input		8	7	bool		R	bit 7... Input to low
Power Supply down		9	8	bool		R	bit 8... No link from IO-Link Transceiver to Power Supply
Predictive Maintenance Power Supply		10	9	bool		R	bit 9... Operating hours exceed estimated lifetime
PSU hardware failure		14	13	bool		R	bit 13...PSU hardware failure

Octet 0

Subindex	15	14	13	12	11	10	9	8
Bit offset	-	-	14	-	-	-	10	9

Octet1

Subindex	7	6	5	4	3	2	1	0
Bit offset	8	7	6	5	4	3	2	1

All parameters are specified at 24 V, 12.5 A, 230 Vac, 25 °C ambient and after a 5 minutes run-in time unless otherwise noted.

Parameter	Para. Index	Sub-index	Data type	Bit offset	Data Format	Resolution	Default values	Read [R] Write [W]	Allowed values	Description
Temperature secondary inside	69	0	int16	15-0	Q9.7	2 ⁻⁷ °C/bit		R	-5120...32640	Temperature secondary inside PSU -40 .. 150°C
Max. temperature secondary inside	70	0	int16	15-0	Q9.7	2 ⁻⁷ °C/bit		R	-5120...32640	Maximum temperature secondary inside PSU -40 .. 150°C
Temperature primary inside	71	0	int16	15-0	Q9.7	2 ⁻⁷ °C/bit		R	-5120...32640	Temperature primary inside -40 .. 150°C
Max. temperature primary inside	72	0	int16	15-0	Q9.7	2 ⁻⁷ °C/bit		R	-5120...32640	Maximum temperature primary inside -40 .. 150°C
AC Input Voltage RMS	78	0	uint16	15-0	Q12.4	2 ⁻⁴ V/bit		R	0...24000 (0-1500V)	Actual Input Voltage RMS (phase-phase)
Actual output voltage	79	0	uint16	15-0	Q8.8	2 ⁻⁸ V/bit		R	0...12544 (0-49V)	Actual average output voltage
Actual output current	81	0	uint16	15-0	Q8.8	2 ⁻⁸ V/bit		R	0...12800 (0-50V)	Actual average output current
E-Fuse current all CHs		0	Unit16 array	31-0	Q8.8	2 ⁻⁸ A/bit			0...12800 (0-50A)	Actual average E-Fuse current all CH
E-Fuse current CH1	84	1	uint16	31-16	Q8.8	2 ⁻⁸ A/bit		R	0...12800 (0-50A)	Actual average E-Fuse current CH1
E-Fuse current CH2		2	uint16	15-0	Q8.8	2 ⁻⁸ A/bit			0...12800 (0-50A)	Actual average E-Fuse current CH2
E-Fuse output status Channel 1 Channel 2	85	0	Array of bool 8-bit Record	0 1				R	0...off 1...on	Dynamic bit 2...7 not used Access via subindex 0 only
E-Fuse trip status CH1 E-Fuse trip status CH2	86	0	4-bit enum array	3-0 7-4				R	0 = No trip 1 = Over-load trip 2 = Short circuit trip 3 = Temperature trip 4 = Power budget trip 5 = Installation failure trip 6 = Sensor fault trip 7 = Fatal fault trip	Dynamic Access via subindex 0 only
Stress level	66	0	uint8	7-0				R	0 ... "<=5%" 1 ... ">5%" 2 ... ">=25%" 3 ... ">=50%" 4 ... ">=75%"	current load

All parameters are specified at 24 V, 12.5 A, 230 Vac, 25 °C ambient and after a 5 minutes run-in time unless otherwise noted.

Parameter	Para. Index	Sub-index	Data type	Bit offset	Data Format	Resolution	Default values	Read [R] Write [W]	Allowed values	Description
Remaining Endurance LED coded	67	0	uint8	7-0				R	0 ... "<=10%" 1 ... ">10%" 2 ... ">=25%" 3 ... ">=50%" 4 ... ">=75%"	dynamic
Remaining Endurance	68	0	uint8	7-0		%	99	R	10...99	Remaining Endurance in percent Value range 10 to 99 %

All parameters are specified at 24 V, 12.5 A, 230 Vac, 25 °C ambient and after a 5 minutes run-in time unless otherwise noted.

Counter

Parameter	Para. Index	Sub-index	Data type	Bit offset	Data Format	Resolution	Default value	Read [R] Write [W]	Allowed values	Description
E-Fuse Number of Startups all CHs		0	uint32 array	63-0					0...150000	Number of Startups all Channels
E-Fuse Number of Startups CH1	87	1	uint32	63-32			0	R	0...150000	Number of Startups Channel 1
E-Fuse Number of Startups CH2		2	uint32	31-0					0...150000	Number of Startups Channel 2
E-Fuse Number of Overcurrents all CHs		0	uint16 array	31-0						Number of Overcurrents all Channels
E-Fuse Number of Overcurrents CH1	88	1	uint16	31-16			0	R		Number of Overcurrents Channel 1
E-Fuse Number of Overcurrents CH2		2	uint16	15-0						Number of Overcurrents Channel 2
Operating time		0								Access via subindex 0 only
hours	73		uint32	39-8		h		R		Operating hours
minutes			uint8	7-0		min			0...59	Operating minutes
Transient VDE-0160 Counter overall	74	0	uint32	31-0			0	R	0...150000	Transient Counter overall
Transient VDE-0160 Counter last 2 minutes	75	0	uint32	31-0			0	R	0...150000	Transient Counter last 2 minutes
Turn-on Counter	82	0	uint32	31-0				R	0...150000	Turn-on Counter of the PSU
Uptime since last turn-on		0								Access via subindex 0 only
hours	83		uint32	39-8		h		R		Uptime since last turn-on - hours
minutes			uint8	7-0		min			0...59	Uptime since last turn-on - minutes

All parameters are specified at 24 V, 12.5 A, 230 Vac, 25 °C ambient and after a 5 minutes run-in time unless otherwise noted.

Device Status

Parameter	Para. Index	Sub-index	Data type	Bit offset	Read [R] Write [W]	Allowed values	Description
Device Status	36	0	uint8	7-0	R	0...Device is operating properly 1...Maintenance-Required 2...Out-of-Specification 3...Functional-Check 4...Failure	0...Device is operating properly 1...Maintenance-Required 2...Out-of-Specification 3...Functional-Check 4...Failure
Detailed Device Status	37	0	3-OctetString array[5]				
Item [1]		1	3-OctetString	119-96			
Item [2]		2	3-OctetString	95-72			Shows up to 5 pending events (3 octets per subindex)
Item [3]		3	3-OctetString	71-48	R		
Item [4]		4	3-OctetString	47-24			Octet 1...EventQualifier
Item [5]		5	3-OctetString	23-0			Octet 2, 3...EventCode

All parameters are specified at 24 V, 12.5 A, 230 Vac, 25 °C ambient and after a 5 minutes run-in time unless otherwise noted.

24.3. Events

This information is triggered by certain situations and will result in an event notification to the IO-Link master. Typical events are notification in case of ideal (e.g. DC-OK) and non-ideal situations (e.g. ambient temperature too hot, high input voltage etc.).

Events	Event-code	Event-type	Description
Parameter error – Check data sheet and values	0x6320	Error	
Device temperature over-run – Clear source of heat	0x4210	Warning	
Events. DC-Warning	0x1800	Warning	Output voltage dips more than 10% below adjusted output voltage
Events. Bonus Power	0x1801	Notification	Output current is 5% more than maximum for more than 3s
Events. Over Load	0x1802	Warning	Load higher than allowed
Events. High Voltage Input	0x1803	Warning	Input to high
Events. Low Voltage Input	0x1804	Warning	Input to low
Events. Power Supply down	0x1805	Warning	No link from IO-Link Transceiver to Power Supply
Events. Predictive Maintenance Power Supply	0x1806	Warning	The estimated remaining lifetime has reached 10%. Performance of PSU might be limited due to aging effects of components.
Events. PSU setting changed via HMI	0x1809	Notification	A PSU setting was changed via man-machine interface.
Events. PSU hardware failure	0x1825	Warning	Critical PSU hardware failure detected. PSU shut down.
Events. PSU output current pre-alarm	0x1830	Warning	Total PSU output current exceeds pre-alarm limit
Events. E-Fuse CH1 Tripped	0x1840	Warning	E-Fuse Ch1 tripped due to overcurrent
Events. E-Fuse CH2 Tripped	0x1841	Warning	E-Fuse Ch2 tripped due to overcurrent
Events. Output current pre-alarm CH1	0x1850	Notification	Output current on E-Fuse Ch1 exceeds pre-alarm limit
Events. Output current pre-alarm CH2	0x1851	Notification	Output current on E-Fuse Ch2 exceeds pre-alarm limit

All parameters are specified at 24 V, 12.5 A, 230 Vac, 25 °C ambient and after a 5 minutes run-in time unless otherwise noted.