

POWER SUPPLY 100-240Vac 24V 300W

- IP 65/67 Degree of protection
- 600 W_{peak} 5 s
- 1AC 100-240 V wide-range input
- 3 switchable outputs
- Outputs for actors and sensors shares one channel
- 95.7 % full load and excellent partial load efficiencies
- DIN rail mounting possible, option "D"
- Output connected to PE (PELV)
- Version without connection to PE on request
- Large output capacitors
- Not potted
- Negligible low input inrush current surge
- Full power between -25 °C and +55 °C
- Output OK
- 3 years warranty

GENERAL DESCRIPTION

The FPS300 is an industrial grade power supply for the 1-phase mains system, it is incorporated into a rugged wall-mount housing with an IP65/67 degree of protection.

It provides two to four stabilized outputs that are galvanically separated from the input. The negative potential of the outputs is permanently connected to PE within the unit.

The most outstanding features of the FPS series are the compact size, the wide operating temperature range, the extremely low input inrush current and the very high efficiencies, which are achieved through various design technologies. Large output capacitors can absorb and store regenerative energy from breaking motors.

Various connector options support the different needs of individual applications. Please contact PULS for possible options. High immunity to transients and power surges as well as low electromagnetic emissions and an international approval package makes the use in nearly every application possible.

SHORT-FORM DATA

| | | |
|-------------------|---------------------------------|---------------------------|
| Output voltage | DC 24 V | Nominal |
| Adjustment range | 24-28 V | Factory setting 24.5 V |
| Output power | Continuous: 360 / 300 / 150 W | Up to: +45 / +55 / +70 °C |
| | Short term up to 5 s | 600 / 300 W +55 / +70 °C |
| Derate linearly | +55 °C to +70 °C | |
| Number of output | 3 | |
| Output currents | Settable per output; up to 10 A | |
| Input voltage AC | 1AC 100-240 V | -15 / +10 % |
| Input voltage DC | DC 110-300 V*) | ±20 % |
| Power factor | 0.99 / 0.97 | At 120 / 230 Vac |
| AC Inrush current | 2.6 / 6 A _{peak} | At 120 / 230 Vac |
| Efficiency | 94.3 / 95.7 % | At 120 / 230 Vac |
| Losses | 18.1 / 13.5 W | At 120 / 230 Vac |
| Hold-up time | 44 / 44 ms | At 120 / 230 Vac |
| Temperature range | -25 °C to +70 °C | |
| Size (wxhxd) | 181x183x59 mm | Without connectors |
| Weight | 1200 g / 2.7 lb | |

*) For DC supply voltages above 150 Vdc an external fuse is required.

ORDER NUMBERS

| | | |
|---------------------|---------------------|-----------|
| Description: | Power supply FPS300 | |
| Order Number | Input | Output |
| FPS300.245-049-102* | 7/8" 3pin | 7/8" 4pin |

| | |
|------------------|------------|
| Accessories: | Chapter 21 |
| Related Products | Chapter 22 |

*For DIN rail mounting PSU: (Order Number)D
e.g. FP300.245-049-102D

MAJOR APPROVALS AND CONFORMITY

For details or a complete approval list, see chapter 21.

CB Report



IEC 62368-1
IEC 61010-2-201

INDEX

| | | | |
|--|----|--|----|
| INDEX | 2 | 16. Environment | 20 |
| 1. Intended Use | 4 | 17. Safety and Protection Features..... | 21 |
| 2. Installation Instructions | 4 | 18. Dielectric Strength..... | 22 |
| 3. AC-Input | 5 | 19. Approvals and Fulfilled Standards..... | 23 |
| 4. DC-Input | 6 | 20. Regulatory Compliance | 23 |
| 5. Input Inrush Current | 6 | 21. Accessories | 24 |
| 6. Output | 7 | 21.1. DIN RAIL Mounting KIT: ZM.FPDRA-11 | 24 |
| 7. Hold-up Time | 9 | 21.2. Mounting Braket: ZM.FPMBA-11..... | 24 |
| 8. Output-OK Relay Contact..... | 10 | 21.3. Connectors..... | 25 |
| 9. Efficiency and Power Losses | 11 | 22. Related Products..... | 26 |
| 10. Lifetime Expectancy..... | 12 | 23. Application Notes..... | 27 |
| 11. MTBF..... | 12 | 23.1. Repetitive Pulse Loading..... | 27 |
| 12. Functional Diagram | 13 | 23.2. External Input Protection..... | 27 |
| 13. Dimensions and Connector Variants..... | 14 | 23.3. Inductive and Capacitive Loads | 27 |
| 14. User Interface..... | 15 | 23.4. Back Feeding Loads | 27 |
| 15. EMC..... | 18 | 23.5. Mounting Orientations..... | 28 |

The information given in this document is correct to the best of our knowledge and experience at the time of publication. If not expressly agreed otherwise, this information does not represent a warranty in the legal sense of the word. As the state of our knowledge and experience is constantly changing, the information in this data sheet is subject to revision. We therefore kindly ask you to always use the latest issue of this document (available under www.pulspower.com).

No part of this document may be reproduced or utilized in any form without our prior permission in writing.

Packaging and packaging aids can and should always be recycled. The product itself may not be disposed of as domestic refuse.

TERMINOLOGY AND ABBREVIATIONS

| | |
|------------------------|--|
| PE and \oplus Symbol | PE is the abbreviation for Protective Earth and has the same meaning as the symbol \oplus . |
| Earth, Ground | This document uses the term "earth" which is the same as the U.S. term "ground". |
| T.b.d. | To be defined, value or description will follow later. |
| AC 230 V | A figure displayed with the AC or DC before the value represents a nominal voltage with tolerances (usually $\pm 15\%$) included. E.g.: DC 12 V describes a 12 V battery disregarding whether it is full (13.7 V) or flat (10 V) |
| 230Vac | A figure with the unit (Vac) at the end is a momentary figure without any additional tolerances included. |
| 50Hz vs. 60Hz | As long as not otherwise stated, AC 100V and AC 230V parameters are valid at 50Hz mains frequency. AC 120V parameters are valid for 60Hz mains frequency. |
| may | A key word indicating flexibility of choice with no implied preference. |
| shall | A key word indicating a mandatory requirement. |
| should | A key word indicating flexibility of choice with a strongly preferred implementation. |
| Us | Sensor output |
| Ua | Actor output |

All parameters are specified at 24V, 12.5A, 230Vac, 25°C ambient and after a 5 minutes run-in time unless otherwise noted.

NOMENCLATURE

| Detail | Description |
|-----------|--|
| FPT | 380-480 V 3 Phase IP54-67 Power Supply |
| FPS | 100-240 V 1 Phase IP54-67 Power Supply |
| FPH | 200-240 V 1 Phase IP54-67 Power Supply Highline Input Voltage |
| 300 | 300 W Power Class |
| 500 | 500 W Power Class |
| 241 / 481 | Standard Power Supply with Output Voltage 24-28 V / 48-52 V Setting and LED Bar |
| 242 / 482 | Basic Power Supply without Voltage Setting and LED-Bar. This version has a status LED Bar. |
| 245 / 485 | Power Supply with up to 4 E-Fuse Channels |
| 246 / 486 | Power Supply with up to 4 NEC Class II Channels |
| 247 / 487 | Power Supply with NEC Class II and E-Fuse Channel |
| 0xx | Terminal configuration e.g. .002. Input: HanQ4/2 Com: M12-A Output: HanQ4/0 |
| 1xx | Consecutively numbered |

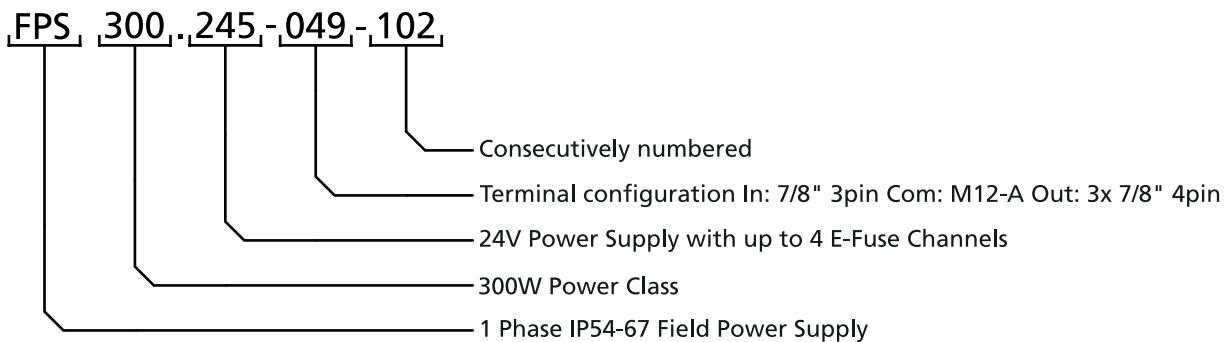

1. Intended Use

This device is designed for indoor use and is intended for commercial applications, such as in industrial control, process control, monitoring and measurement equipment.

Do not use this device in equipment where malfunction may cause severe personal injury or threaten human life. If this device is used in a manner outside of its specification, the protection provided by the device may be impaired.

2. Installation Instructions

⚠ DANGER Risk of electrical shock, fire, personal injury or death.

- Turn power off before working on the device. Protect against inadvertent re-powering.
- Do not open, modify or repair the device.
- Do not touch during power-on and immediately after power-off. Hot surfaces may cause burns.
- Install the device on a large enough flat surface. Sharp edges on the back may cause injury.
- If damages or malfunctioning occur during installation or operation, immediately turn power off and send unit to the factory for inspection.
- The device is designed as “Class of Protection I” equipment according to IEC 61140. Do not use without a proper PE (Protective Earth) connection.

⚠ WARNING Risk of damages on the device

- Keep the following minimum installation clearances: 30 mm on top and bottom, 10 mm on the front and 10 mm left and right side.
- The maximum surrounding air temperature is +70 °C (+158 °F). The operational temperature is the same as the ambient or surrounding air temperature and is defined 2 cm below the device.
- The device is designed to operate in areas between 5 % and 95 % relative humidity.
- Clean only with a damp cloth.

Obey the following installation instructions:

This device may only be installed and put into operation by qualified personnel. This device does not contain serviceable parts. The tripping of an internal fuse is caused by an internal defect. Install the device onto a flat surface with the terminals on the bottom of the device. Other mounting orientations require a reduction in output power, chapter 23.6.

For wall mounting use 4 screws. Two on top and 2 on bottom mounting holes. Recommended screw size is M4 (UNC 8-32). The enclosure of the device provides a degree of protection of IP65/67 when installed with all mating connectors firmly connected. The device is designed for pollution degree 3 areas in controlled environments.

Assure that during installation no moisture or dirt gets into the connections. Operation in areas where moisture or condensation can be expected is possible.

The negative potential of the outputs is permanently connected to PE within the unit. Do not connect the negative potential of any output to PE outside the unit.

For TN, TT mains systems with earthed neutral and IT star mains systems with insulation monitoring the device is designed for overvoltage category III zones up to 2000 m (6560 ft) and for overvoltage category II zones up to 5000 m (16400 ft).

For TN, TT, IT delta mains systems or IT star mains systems without insulation monitoring the device is intended for overvoltage category II zones up to 2000 m (6560 ft).

The device is designed for altitudes up to 5000 m (16400 ft). Above 2000 m (6560 ft) a reduction in output current is required and the operation is limited according mains systems described above. The device is designed, tested and approved for branch circuits up to 20 A (UL) and 32 A (IEC) without additional protection device. If an external fuse is utilized, do not use circuit breakers smaller than 6 A B- or C-characteristic to avoid a nuisance trip. A disconnecting means shall be provided for the input of the device. This must be suitably located and easily accessible. The disconnecting means must be marked as the such for the device.

3. AC-Input

The device is suitable to be supplied from TN, TT or IT mains networks. For more details, please review chapter 2.

| | | | |
|------------------------------|------------------------------------|---------------------------|---|
| AC input voltage rated range | nom. | AC 100-240 V | |
| AC input operating range | | 85-264 Vac 264-300 Vac | Continuous operation For maximal 500ms |
| Input frequency | Nom. | 50–60 Hz | ±6 % |
| Turn-on voltage | Typ. | 80 Vac | Steady-state value, see Fig. 3-1 |
| Shut-down voltage | Typ. | 70 Vac | Steady-state value, see Fig. 3-1 |
| External input protection | See recommendations in chapter 2 . | | |

| | | AC 100 V | AC 120 V | AC 230 V | |
|-------------------|------|----------|----------|----------|--|
| Input current | typ. | 3.98 A | 3.2 A | 1.68 A | At 360 W, symmetrical phase voltages, see Fig. 3-3 Power |
| Power factor*) | typ. | 0.99 | 0.99 | 0.97 | At 360 W, see Fig. 3-4 |
| Start-up delay | typ. | 2 s | 2 s | 2 s | At 300 W symmetrical phase voltages, see Fig. 3-2 |
| Rise time | typ. | 22 ms | 22 ms | 22 ms | At 300 W constant current load, 0mF load, see Fig. 3-2 |
| | typ. | 48 ms | 46 ms | 35 ms | At 300 W constant current load, 12.5mF, see Fig. 3-2 |
| Turn-on overshoot | Max. | 200 mV | 200 mV | 200 mV | See Fig. 3-2 |

*) The power factor is the ratio of the true (or real) power to the apparent power in an AC circuit.

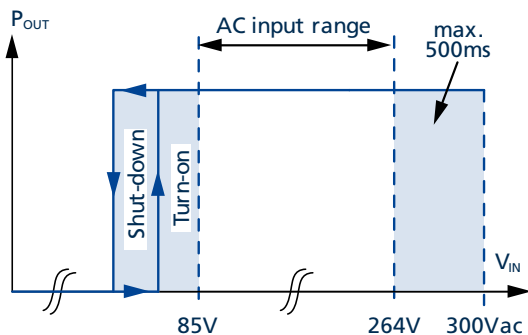

Fig. 3-1: Input voltage range

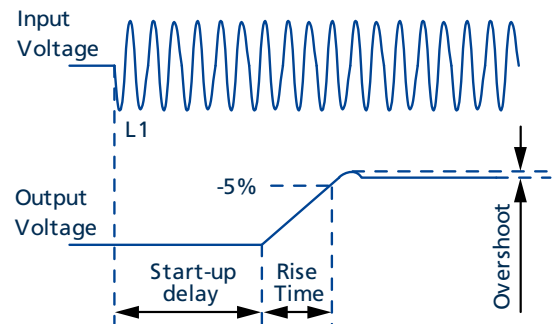

Fig. 3-2: Turn-on behavior, definitions

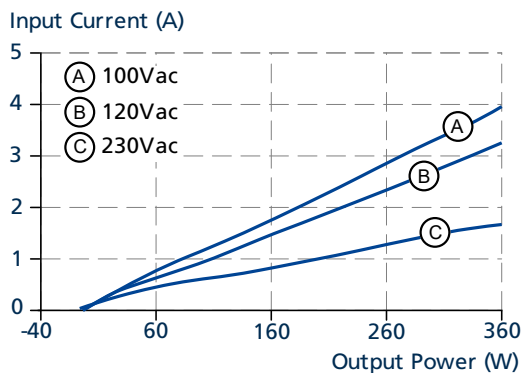

Fig. 3-3:
Input current vs. output power at 24 V output voltage

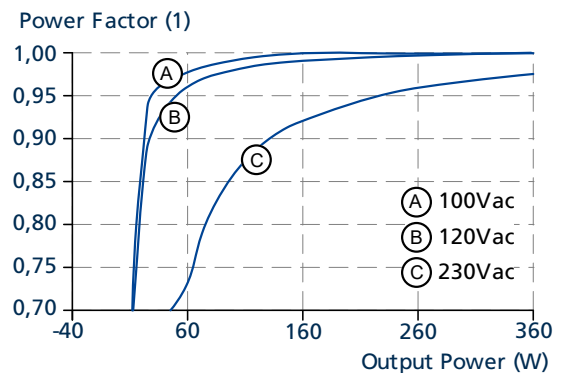

Fig. 3-4:
Power factor vs. output power at 24 V output voltage

All parameters are specified at 24 V, 12.5 A, 230 Vac, 25 °C ambient and after a 5 minutes run-in time unless otherwise noted.

4. DC-Input

The device is suitable to be supplied from a DC input voltage.

| | | | |
|-------------------|------|----------------|----------------------------|
| DC input*) | nom. | DC 110-300 V*) | ±20 % |
| DC input range | min. | 88 Vdc | |
| | max. | 360 Vdc | |
| DC input current | typ. | 2.90 A | At 110 Vdc, at 24 V, 300 W |
| | typ. | 1.04 A | At 300 Vdc, at 24 V, 300 W |
| Turn-on voltage | Typ. | 80 Vac | |
| Shut-down voltage | Typ. | 70 Vac | |

*) For DC supply voltage above 150Vdc an external fuse with an appropriate rating is required. Wide range DC input 110-300V without external fuse on request.

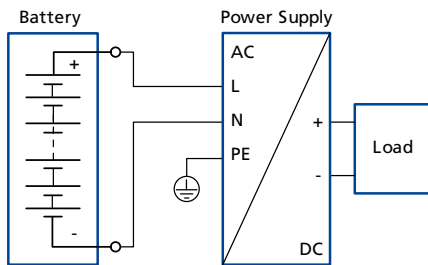

Fig. 4-1: Wiring for DC Input

Instructions for DC use:

- Use a battery or a similar DC source. A supply from the intermediate DC-bus of a frequency converter is not recommended and can cause a malfunction or damage the unit.
- Connect +pole to L and -pole to N.
- Connect the PE terminal to an earth wire or to the machine ground.

5. Input Inrush Current

An active inrush limitation circuit (NTCs, which are bypassed by a relay contact) limits the input inrush current after turn-on of the input voltage.

The charging current into EMI suppression capacitors is disregarded in the first microseconds after switch-on.

| Inrush current | max. | AC 100 V | AC 120 V | AC 230 V |
|----------------|------|------------------------|-----------------------|---------------------|
| | | 2.18 A _{peak} | 2.6 A _{peak} | 6 A _{peak} |

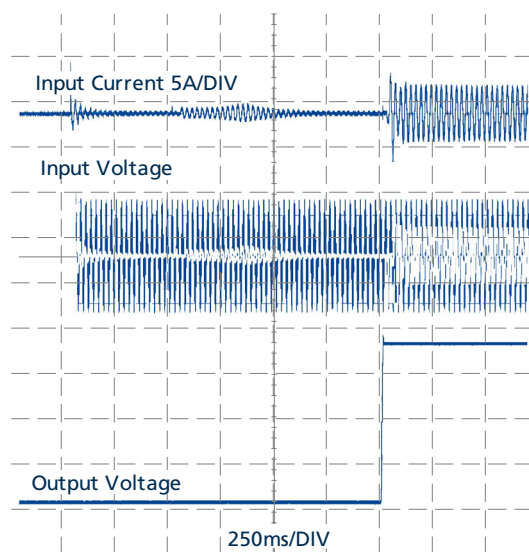

Fig. 5-1: Typical turn-on behavior at nominal load and 25 °C ambient temperature

All parameters are specified at 24 V, 12.5 A, 230 Vac, 25 °C ambient and after a 5 minutes run-in time unless otherwise noted.

6. Output

The outputs provide a (PELV/ES1) rated voltage, which is galvanically isolated from the input voltage. The negative potential of the outputs is permanently connected to PE within the unit. Do not connect any output to PE (Ground).

The device is designed to supply any kind of loads, including capacitive and inductive loads. If capacitors with a capacitance >20mF are connected to one output, this output might switch off after turning the unit or the output on or connecting the load.

All outputs are individually current limited. In case of an overload, the individual output switches off and needs to be reset manually with the reset button on the front of the device or via IO-Link. A cycling of the input power does not reset the output. The failure signals are stored until a reset is intentionally initiated.

For protection reasons a delay of at least 5 seconds is mandatory, before an output can be reset after it has been switched off. Otherwise the green LED will flicker after pushing the button. The unit is shipped with all outputs turned on. The ON/OFF function has no safety feature included.

The sum of the configured output power of all outputs may exceed the total output power of available power budget, see Fig. 6-2. If this is the case, the output with the highest number will tripped first followed by the next output to ensure that the lower channel number will supply continuous power and see no voltage dips.

Outputs start sequentially from 1 to 4 with an interval of 150ms, see Fig. 6-1.

| | | | | | |
|--------------------------|---------------------|---|----------------|---|----------------------------|
| Number of outputs | | 3 | | | |
| Output voltage | Nom. | 24 V | | Factory setting 24.5 V | |
| Adjustment range | | 24-28 V | | Adjustable in steps: 24 V, 24.5 V, 25 V, 25.5 V, 26 V, 26.5 V, 27 V and 28 V | |
| Factory setting | Typ. | 24.5 V | | ±0.2 %, at nominal load | |
| Line regulation | Max. | 25 mV | | Between 85 and 300 Vac input voltage change | |
| Load regulation | Typ. | 250 mV | | Between 0 and 360 W output load, static value | |
| Ripple and noise voltage | Max. | 50 mVpp | | Bandwidth 20 Hz to 20 MHz, 50 Ohm | |
| Output current | Order number | | Outputs | Connector | Max. current |
| | FPS300.245-049-102 | | 3 | 3x 7/8" – 4pin | 10 A each output |
| | | | | | Picture Fig. 6-3 |
| Total output power | Nom. | 360 W | | Up to +45 °C at ambient temperatures, for the sum of all outputs. | |
| | Nom. | 300 W | | At +55 °C at ambient temperatures, for the sum of all outputs. | |
| short term up to 5s | Nom. | 150 W | | At +70 °C at ambient temperatures, for the sum of all outputs. | |
| | Nom. | 600 W | | Up to +55 °C at ambient temperatures, for the sum of all outputs. | |
| | Nom. | 300 W | | At +70 °C at ambient temperatures, for the sum of all outputs. | |
| | | Derate linearly between +55 °C and +70 °C | | | |
| Overload behavior | | Trip curve | | See Fig. 6-3 | |
| Output capacitance | Typ. | 12 500 µF | | Included inside the power supply, common for all four outputs | |
| Parallel Use | | | | Do not parallel units for higher output currents | |
| Back-feeding loads | Max. | 35 V / 4 J | | The unit is resistant and does not show a malfunction when a load feeds back voltage to the power supply. It does not matter whether the power supply is on or off. For all four outputs in total | |

All parameters are specified at 24 V, 12.5 A, 230 Vac, 25 °C ambient and after a 5 minutes run-in time unless otherwise noted.

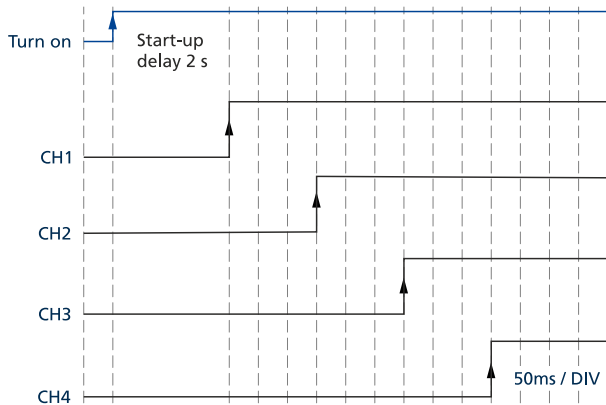

Fig. 6-1: Sequential start of the outputs

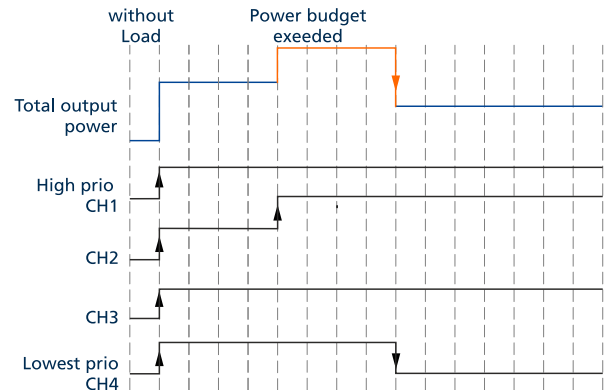

Fig. 6-2:
Tripping of the channel with the lowest priority when the power budget is exceeded

Time delay before switch off at overloads, typ. (s)

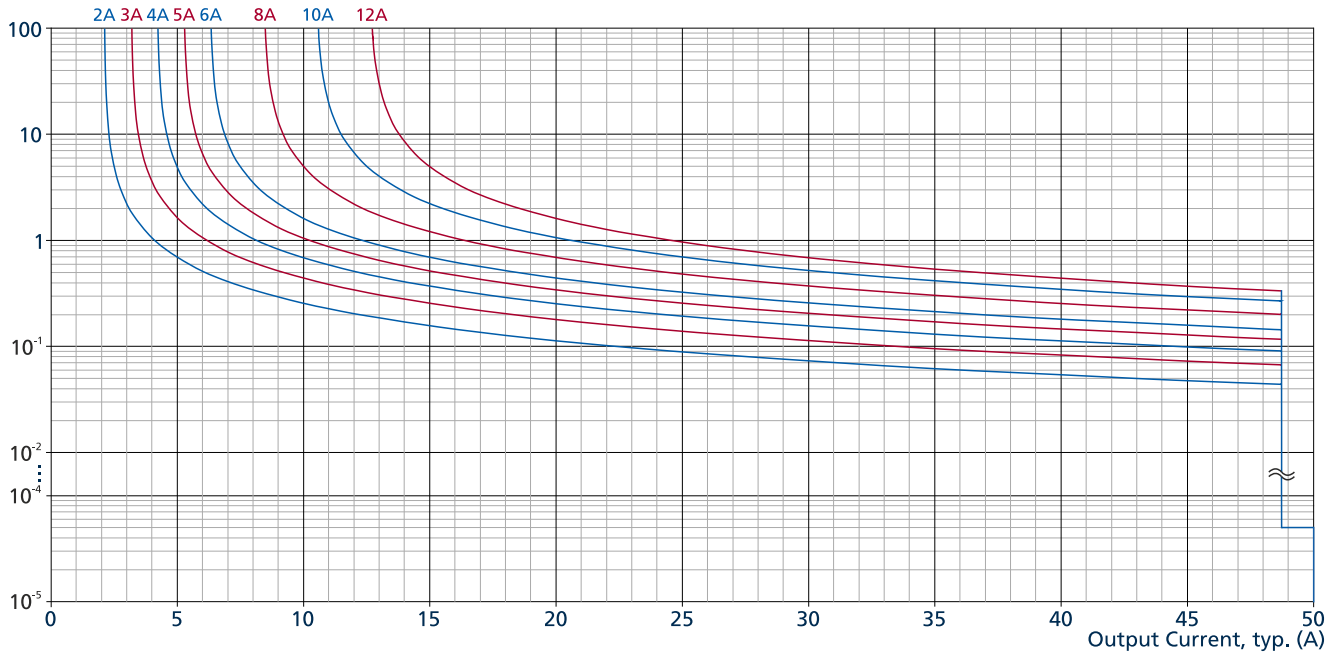

Fig. 6-3: Trip curve diagram

7. Hold-up Time

The hold-up time is the time during which a power supply's output voltage remains within specification following the loss of input power. The hold-up time is output load dependent. At no load, the hold-up time can be up to several seconds. The status LED is also on during this time.

| Hold-up Time | | AC 100 V | AC 120 V | AC 230 V | |
|--------------|------|----------|----------|----------|------------------------------------|
| | | typ. | 75 ms | 75 ms | |
| | min. | 56 ms | 56 ms | 56 ms | At 150 W output load, see Fig. 7-1 |
| | typ. | 44 ms | 44 ms | 44 ms | At 300 W output load, see Fig. 7-1 |
| | min. | 29 ms | 29 ms | 29 ms | At 300 W output load, see Fig. 7-1 |

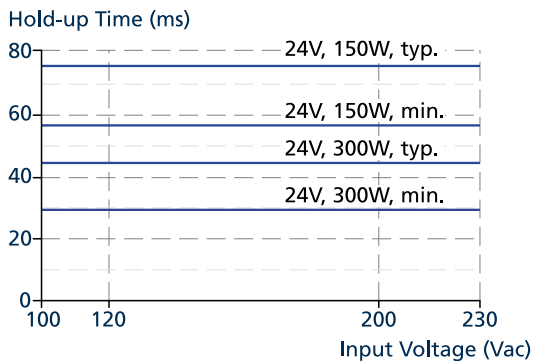

Fig. 7-1: Hold-up time vs. input voltage

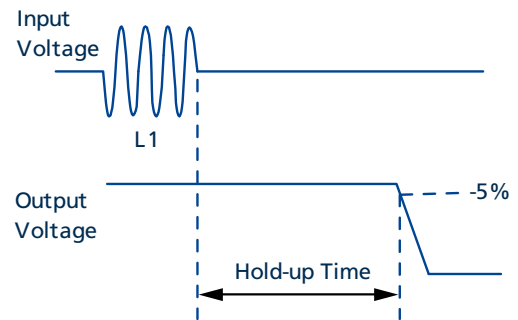

Fig. 7-2: Shut-down behavior, definitions

8. Output-OK Relay Contact

This feature monitors the output voltage, which is produced by the power supply itself. It is independent of an eventually present external voltage on the output of the power supply.

| | |
|----------------------|--|
| Contact closes | As soon as the output voltage reaches typ. 22 Vdc. The Output-OK Relay Contact is synchronized with the Status Led. |
| Contact opens | As soon as the output voltage dips below 22 Vdc. Short dips will be extended to a signal length of 100 ms. Dips Shorter than 1ms will be ignored. |
| Switching hysteresis | 1V |
| Contact ratings | Maximal 60 Vdc 0.3 A, 30 Vdc 1 A, 30 Vac 0.5 A, resistive load Minimal permissible load: 1 mA at 5 Vdc |
| Isolation voltage | See dielectric strength table in chapter 18. |

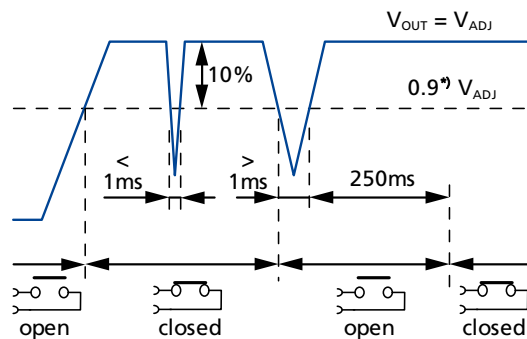

Fig. 8-1: Output-OK relay contact behavior

9. Efficiency and Power Losses

| | | AC 100 V | AC 120 V | AC 230V | |
|----------------------|------|----------|----------|---------|---|
| Efficiency | typ. | 93.6 % | 94.3 % | 95.7 % | At 24 V, 300 W |
| Average efficiency*) | typ. | 92.9 % | 93.5 % | 94.6 % | 25 % at 80 W, 25 % at 150 W, 25 % at 220 W, 25 % at 300 W |
| Power losses | typ. | 2.7 W | 2.8 W | 2.2 W | At 24 V, 0 W (no load) |
| | typ. | 10.7 W | 10.0 W | 8.3 W | At 24 V, 150 W (half load) |
| | typ. | 20.5 W | 18.1 W | 13.5 W | At 24 V, 300 W (full load) |

*) The average efficiency is an assumption for a typical application where the power supply is loaded with 25% of the nominal load for 25% of the time, 50% of the nominal load for another 25% of the time, 75% of the nominal load for another 25% of the time and with 100% of the nominal load for the rest of the time.

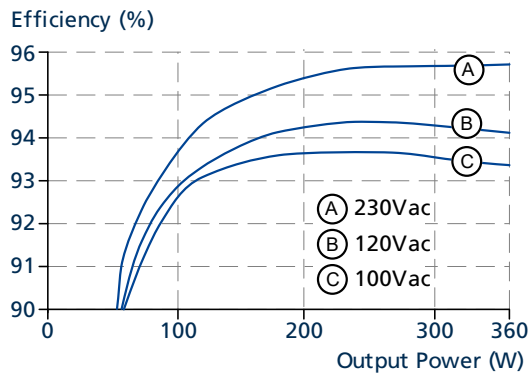

Fig. 9-1: Efficiency vs. output power at 24 V, typ.

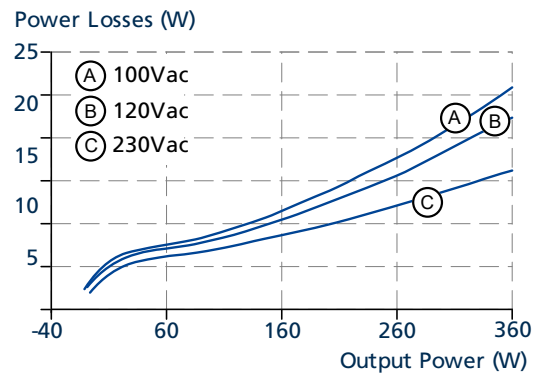

Fig. 9-2: Losses vs. output power at 24 V, typ.

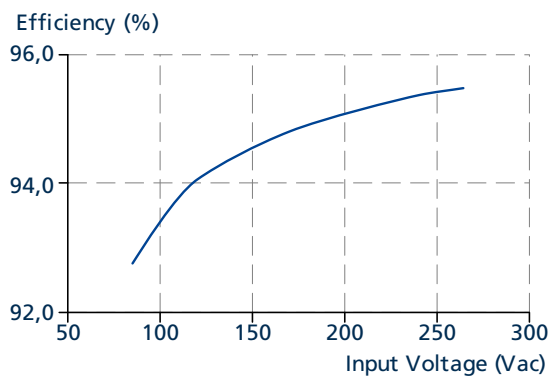

Fig. 9-3: Efficiency vs. input voltage at 24 V, 300 W, typ.

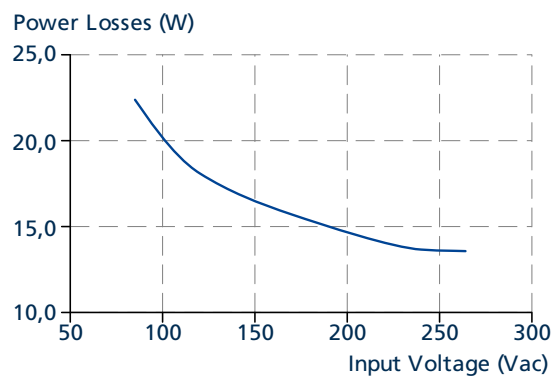

Fig. 9-4: Losses vs. input voltage at 24 V, 300 W, typ.

10. Lifetime Expectancy

The Lifetime expectancy shown in the table indicates the minimum operating hours (service life) and is determined by the lifetime expectancy of the built-in electrolytic capacitors. Lifetime expectancy is specified in operational hours and is calculated according to the capacitor's manufacturer specification.

The manufacturer of the electrolytic capacitors only guarantees a maximum life of up to 15 years (131 400 h). Any number exceeding this value is a calculated theoretical lifetime which can be used to compare devices.

| | 1AC 100 V | 1AC 120 V | 1AC 230 V | |
|--------------------------------|------------------|------------------|------------------|------------------------|
| Calculated lifetime expectancy | 88 600 h | 121 100 h | 175 200 h | At 24V, 300 W and 40°C |
| | 257 900 h | 319 790 h | 410 500 h | At 24V, 150 W and 40°C |
| | 247 300 h | 352 300 h | 432 500 h | At 24V, 300 W and 25°C |
| | 530 100 h | 610 800 h | 834 400 h | At 24V, 150 W and 25°C |

11. MTBF

MTBF stands for **Mean Time Between Failure**, which is calculated according to statistical device failures, and indicates reliability of a device. It is the statistical representation of the likelihood of a unit to fail and does not necessarily represent the life of a product.

A MTBF figure of e.g. 1 000 000 h means that statistically one unit will fail every 100 hours if 10 000 units are installed in the field. However, it can not be determined if the failed unit has been running for 50 000 h or only for 100 h.

For these types of units the MTTF (**Mean Time To Failure**) value is the same value as the MTBF value.

| | 1AC 100 V | 1AC 120 V | 1AC 230 V | |
|-------------------------|------------------|------------------|------------------|--|
| MTBF SN 29500, IEC61709 | 270 000 h | 305 000 h | 384 000 h | At 24 V, 300 W and 40 °C |
| | 489 000 h | 546 000 h | 679 000 h | At 24 V, 300 W and 25 °C |
| MTBF MIL HDBK 217F | 106 000 h | 118 000 h | 135 000 h | At 24 V, 300 W and 40 °C; Ground Benign GB40 |
| | 160 000 h | 175 000 h | 195 000 h | At 24 V, 300 W and 25 °C; Ground Benign GB25 |
| | 29 000 h | 32 000 h | 35 000 h | At 24 V, 300 W and 40 °C; Ground Fixed GF40 |
| | 39 000 h | 42 000 h | 46 000 h | At 24 V, 300 W and 25 °C; Ground Fixed GF25 |

12. Functional Diagram

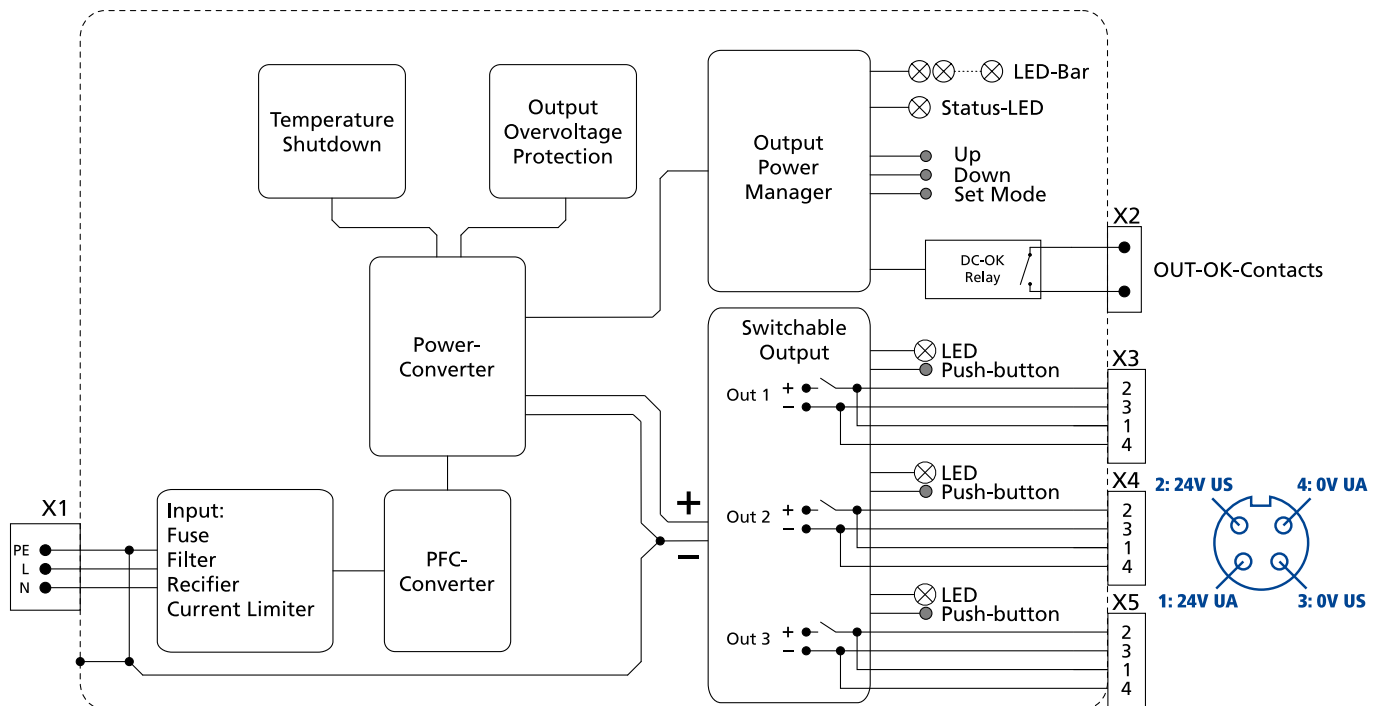
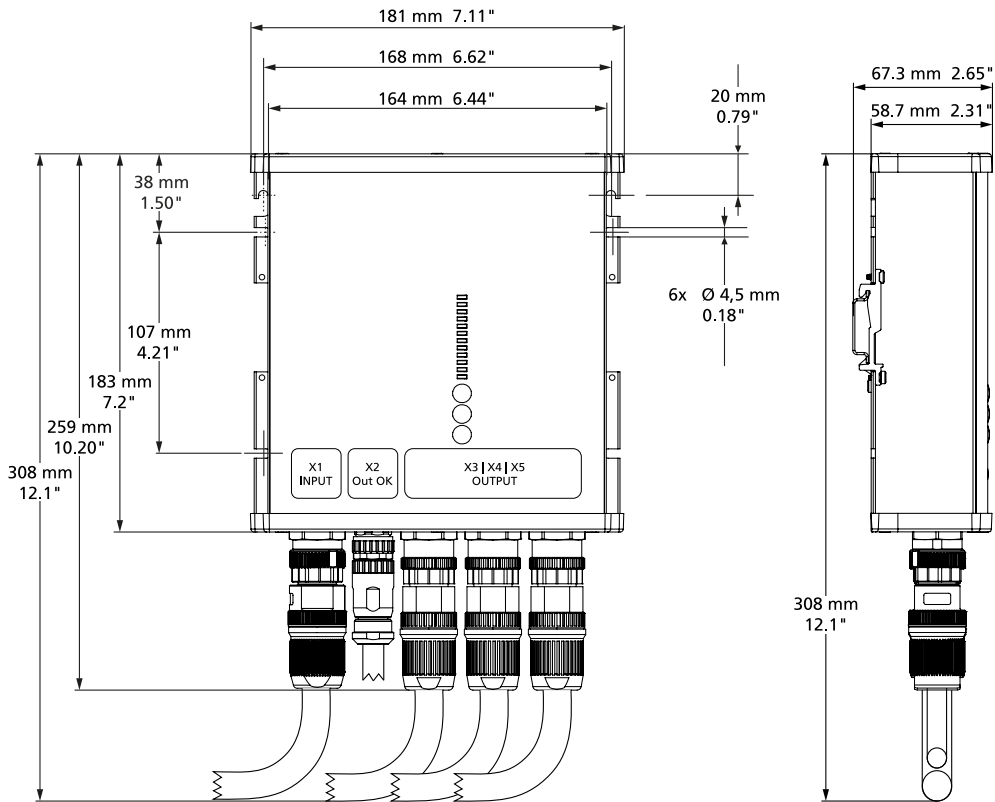

Fig. 12-1: Functional Diagram FPS300.245-049-102

13. Dimensions and Connector Variants

FPS300.245-049-102



Width 181 mm / 7.11"
 Height 183 mm / 7.2"
 Depth 59 mm / 2.32"
 Weight 1200 g / 2.7lb

Housing body material Aluminium alloy
 Housing cover material Hi-grade polycarbonate
 Installation clearances See chapter 2
 Mating connectors See chapter 21.3

Input connector on power supply (X1):

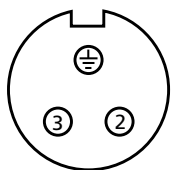

7/8" 3pin Male

Pin Ⓧ: PE connection
 Pin 2: L
 Pin 3: N

IO-Link connector on power supply (X2):

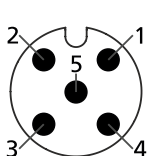

M12-A Male

Pin 1: Relay Connection
 Pin 2: not connected
 Pin 3: not connected
 Pin 4: Relay Connection
 Pin 5: not connected

Output connector on power supply (X3, X4 and X5):

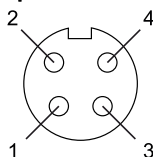

7/8" 4 pin Female

Pin 1: 24 Vdc (Out 1 | 2 | 3) Ua Actor output
 Pin 2: 24 Vdc (Out 1 | 2 | 3) Us Sensor output
 Pin 3: GND (Out 1 | 2 | 3) Us Sensor output
 Pin 4: GND (Out 1 | 2 | 3) Ua Actor output

All parameters are specified at 24 V, 12.5 A, 230 Vac, 25 °C ambient and after a 5 minutes run-in time unless otherwise noted.

14. User Interface

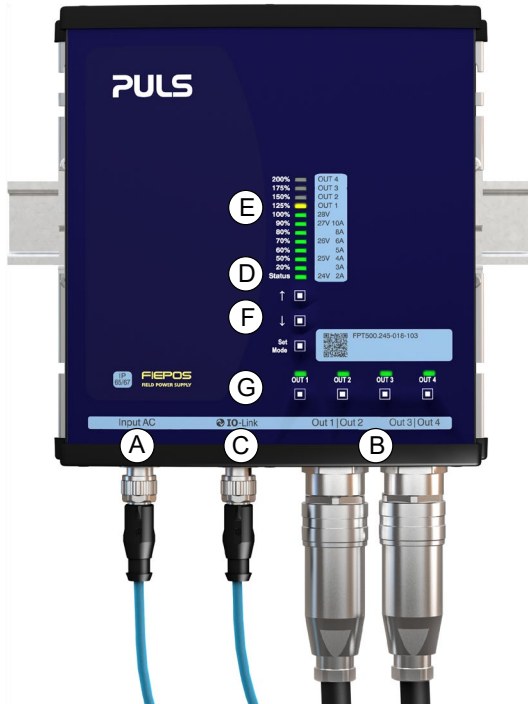

- A Input Connector
- B Output Connectors
- C IO-Link Connector
- D Status LED
- E LED Bar
- F Set Mode and Up and Down Button
- G Output LEDs ON/OFF & Reset Buttons

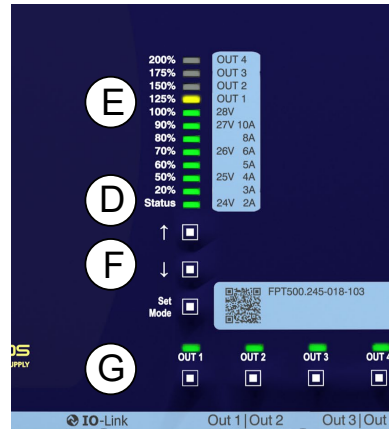

Overview

LED Bar (E)

The LED Bar is a multifunctional displaying tool. The main function is to monitor the sum of all outputs (percentages scale). It also can display the output voltage (voltage scale) and output current (ampere scale) for the individual outputs. The integrated Status LED displays different running conditions of the PSU in real-time.

Output Level Controls (F)

The Output Level Controls consist of the Set Mode button and the UP/DOWN buttons. The Set Mode is used to change into tripping current settings. The UP/DOWN are used to adjust different output levels or change into the Output Current Mode.

Output Controls (G)

The Output Controls consist of an output LED and an Output ON/OFF button (ON/OFF) for each output. The Output LED displays different running conditions for output in real-time. The ON/OFF is used to switch the output on/off.

Operation Settings

Monitor Output Power Mode

The Output Power Mode displays the actual total output power after startup. It is the default mode of the LED Bar. The output Power is Displayed in percentages of 300 W. E.g. If the LED Bar is powered up till 50 %, 150 W is expended. If the LED Bar rises above 100% and therefore exceeds 300 W the 125 %-LED flashes orange. Refer to the percentage scale on the left sidebar.

Monitor Output Current Mode

The Output Current Mode is to check the output current of the individual outputs.

To inspect these output currents:

- Press the UP or DOWN button. OUT1 in the LED bar lights up in orange. The output current is displayed in real-time in the LED Bar below. Refer to the ampere scale on the right sidebar.
- In the LED Bar switch between the OUT1 - OUT4 using the UP/DOWN buttons to check the different output current values.
- Return to the Output Power Mode/default mode by pushing beyond the highest (OUT4) or lowest (OUT1) output number.

All parameters are specified at 24 V, 12.5 A, 230 Vac, 25 °C ambient and after a 5 minutes run-in time unless otherwise noted.

Set Tripping Current

To set a new tripping current:

- Press Set Mode for 3 s. After all LEDs light up once, the LED now displays the set voltage.
- Press Set Mode to select the right output to change the tripping current. The orange LED will indicate which output is selected.
- Push UP/DOWN to increase or decrease the set point. Refer to the current scale on the right sidebar. (e.g. 20 %-LED indicates 3 A).
- New point is set.
- After 15 s of non-action, the PSU will automatically switch to Output Power Mode.

Set Output Voltage

To set a new output voltage:

- Press Set Mode for 3 s. After all LEDs light up once, the LED now displays the set voltage.
- Push UP/DOWN to increase or decrease the set point. Refer to the current scale on the right sidebar. (e.g. 20 %-LED indicates 24.5 V).
- New point is set.
- After 15 s of non-action, the PSU will automatically switch to Output Power Mode.

Set Button Lock

To activate/deactivate the button lock:

- Press the UP and DOWN buttons simultaneously for 3 s. The LED bar will flash for 5 s to indicate the changed button lock status.

Reset Output

In a failure mode where the output did/didn't switched OFF:

- Push and hold ON/OFF for more than 1s.

LED Signaling

Status LED (D)

The Status LED displays different running conditions of the PSU in real-time.



Green: On

DC voltage is above 90 % of set point voltage. All outputs are operating according to their settings.



OFF

DC voltage is below 90 % of set point voltage or an output channel has tripped or PSU is not powered.



Red: AC input failure

AC input drops below the specified levels and outputs turned off.



Flashes orange: Hiccup_{plus} mode!

Output is OFF during these 18s.



Flashes red: Overtemperature

The PSU turns OFF to prevent overheating. Normal operating range continues after the Status LED turns to solid green again.

Channel LED Signaling Overview

Below is an overview of the output LED signaling.

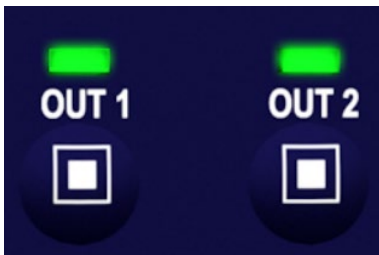













Fig. 14-1: Location of outputs LEDs

- 
OFF
 Output is switched OFF by ON/OFF or PSU is not powered (s. Status LED).
- 
Green: Default
 Output is switched on by ON/OFF.
- 
Flashes green: Power budget tripped (slow rate: 250 ms ON / 250 ms OFF)
 Low priority outputs are tripped. Sum of output currents are above PSU power budget.
- 
Flashes green: Buttons Locked (fast rate: 125 ms ON / 125 ms OFF)
 No action is carried out. Button lock feature activated. Unlock buttons by following Operation Settings > Set Button Lock. Other reason: MOSFET protection MOSFET is >90 °C or Interval between Charge Up/ Turn On cycles <5 s.
- 
Orange: Pre-Alarm!
 Output is still running. Current is above pre-alarm level and close to overload.
- 
Flashes orange: Overload! (slow rate: 500 ms ON / 500 ms OFF)
 Output is tripped. Output current is overloaded. Restart by pushing the ON/OFF.
- 
Flashes orange: Faulty Installation (medium rate: 250 ms ON / 250 ms OFF)
 Output is turned OFF automatically. Cable or connected hardware on the outputs are not installed correctly. Switch OFF the output manually by pushing the specific output ON/OFF button.
 - PSU with NEC Class II outputs: Difference between positive and negative/Input-Output current of the output are >1 A for 6-6.5 s
 - PSU without NEC Class II outputs: Connector negative wire overcurrent according to negative trip curve, or output was contributing to negative overcurrent of another output ($I_{pos} - I_{neg} > \text{threshold}$), or High PE current (>12 A) was detected based on overall output current sum.
- 
Flashes orange: Short Circuit (fast rate: 125 ms ON / 125 ms OFF)
 Output is tripped. The Output's output current exceeded approx. 48A. Short circuit reasons may be electrical short, loads beyond specification, plugging-in a large capacitance during operation, etc. After pushing of specific output ON/OFF button, e-fuse output tries to turn ON.
- 
Flashes Orange/Green: Overtemperature! (slow rate, 250 ms orange / 250 ms)
 Output will automatically turned OFF when MOSFET overtemperature (125 °C) is reached. When MOSFET temperature falls below 90 °C the output will turn on automatically.
- 
Red: Fatal MOSFET Malfunction!
 PSU turns OFF. Power switch on specific output is damaged. Replacement of PSU might be required.
 Possible malfunction:
 - Positive current output in OFF state exceeds >2 A for more than >0.5 s
- 
Flashes red: Hardware Specs Out of Range! (slow rate, 500 ms ON / 500 ms OFF)
 Affected output channel turns OFF. Measurement Circuit Hardware is out of specified range. Replacement of PSU might be required.

 Possible malfunction:
 - Deviations of internal output current sensors exceed acceptable limits.
 - Temperature sensor measurement out of range (-40 °C or +150 °C) for more than 5 s

All parameters are specified at 24 V, 12.5 A, 230 Vac, 25 °C ambient and after a 5 minutes run-in time unless otherwise noted.

15. EMC

The EMC behavior of the device is designed for applications in industrial environment as well as in residential, commercial and light industry environments.

The device is investigated according to EN 61000-6-1, EN 61000-6-2, EN 61000-6-3, EN 61000-6-4, EN 61000-3-2 and EN 61000-3-3.

EMC immunity

| | | | | |
|----------------------------|---------------|--|---------------|-------------|
| Electrostatic discharge | EN 61000-4-2 | Contact discharge | 8kV | Criterion A |
| Air discharge | | Air discharge | 15kV | Criterion A |
| Electromagnetic RF field | EN 61000-4-3 | 80MHz - 2.7GHz | 20V/m | Criterion A |
| | | 2.7GHz - 6GHz | 10V/m | Criterion A |
| Magnetic field | EN 61000-4-8 | 50Hz/60Hz | 30A/m | Criterion A |
| Fast transients (Burst) | EN 61000-4-4 | AC Input lines | 4kV | Criterion A |
| | | DC Output lines | 4kV | Criterion A |
| | | IO-Link | 4kV | Criterion A |
| Surge voltage on AC input | EN 61000-4-5 | L to N | 2kV | Criterion A |
| | | L to PE, N to PE | 4kV | Criterion A |
| Surge voltage on DC output | EN 61000-4-5 | + to - | 1kV | Criterion A |
| | | +/- to PE | 2kV | Criterion A |
| Surge voltage on OUT-OK | EN 61000-4-5 | OUT-OK to PE | 1kV | Criterion A |
| Conducted immunity | EN 61000-4-6 | 0.15 - 80MHz | 20V | Criterion A |
| Voltage dips | EN 61000-4-11 | 0% of 100Vac | 0Vac, 20ms | Criterion A |
| | | 40% of 100Vac | 40Vac, 200ms | Criterion C |
| | | 70% of 100Vac | 70Vac, 500ms | Criterion C |
| | | 0% of 200Vac | 0Vac, 20ms | Criterion A |
| | | 40% of 200Vac | 80Vac, 200ms | Criterion A |
| | | 70% of 200Vac | 140Vac, 500ms | Criterion A |
| Voltage interruptions | EN 61000-4-11 | 0 V | 5000 ms | Criterion C |
| Voltage sags | SEMI F47 | Dips on the input voltage according to SEMI F47 standard | | |
| | | 80% of 120Vac (96Vac) | 1000ms | Criterion A |
| | | 70% of 120Vac (84Vac) | 500ms | Criterion A |
| | | 50% of 120Vac (60Vac) | 200ms | Criterion A |
| Powerful transients | VDE 0160 | Over entire load range | 750V, 0.3ms | Criterion A |

Performance criterions:

A: The device shows normal operation behavior within the defined limits.

C: Temporary loss of function is possible. The device may shut-down and restarts by itself. No damage or hazards for the device will occur.

EMC Emission

| | | |
|--|--|--|
| Conducted emission AC input lines | EN 55011, EN 55015, EN 55032, FCC Part 15, CISPR 11, CISPR 32 | Class B |
| Conducted emission DC output lines Conducted emission Out-OK output | IEC/CISPR 16-1-2, IEC/CISPR 16-2-1 | |
| Radiated emission | EN 55032 / EN 55011 | Class B |
| Harmonics | EN 61000-3-2 | Class A fulfilled between 0A and 12A load |
| Voltage fluctuations, flicker | EN 61000-3-3 | Pass tested with constant current loads, non pulsing |

This device complies with FCC Part 15 rules.

Operation is subjected to following two conditions: (1) this device may not cause harmful interference, and (2) this device must accept any interference received, including interference that may cause undesired operation.

Switching Frequencies

| | | |
|------------------------|-------------------|---|
| PFC converter | 20 kHz to 135 kHz | Input voltage and output load dependent |
| Main converter | 60 kHz to 140 kHz | Output load dependent |
| Auxiliary converter | 54 kHz to 66 kHz | Output load dependent |
| Microcontroller clocks | 48 Mhz and 32 MHz | Fixed frequency |

16. Environment

| | | |
|-------------------------|---|---|
| Operational temperature | -25 °C to +70 °C (-13 °F to 158 °F) | Operational temperature is the same as the ambient or surrounding temperature and is defined as the air temperature 2cm below the unit. |
| Storage temperature | -40 °C to +85 °C (-40 °F to 185 °F) | For storage and transportation |
| Output derating | 6 W/°C 10 W/°C 20 W/1000 m or 5°C/1000 m | Between +45 °C and +55 °C (113 °F to 131 °F) Between +55 °C and +70 °C (131 °F to 140 °F) For altitudes >2000 m (6560 ft), see Fig. 16 2: Output power vs. altitude The derating is not hardware controlled. The user has to take care to stay below the derated current limits in order not to overload the unit. |
| Humidity | 5 to 95 % r.h. | According to IEC 60068-2-30 |
| Atmospheric pressure | 54-110k Pa | see Fig. 16-2: Output power vs. for details |
| Altitude | Up to 5000 m (16 400 ft) | see Fig. 16-2: Output power vs. for details |
| Over-voltage category | III II | According to IEC 60664-1 For TN, TT mains systems with earthed neutral and IT star mains systems with insulation monitoring for altitudes up to 2000 m According to IEC 60664-1 For TN, TT mains systems with earthed neutral and IT star mains systems with insulation monitoring for altitudes between 2000 m and 5000 m According to IEC 60664-1 For TN, TT, IT Delta mains systems or IT star mains systems without insulation monitoring for altitudes up to 2000 m |
| Degree of pollution | 3 | According to IEC 62477-1, not conductive |
| Vibration sinusoidal | 2-17.8 Hz: ±1.6 mm; 17.8-500 Hz: 2 g 2 hours / axis | According to IEC 60068-2-6 |
| Shock | 30 g 6 ms, 20 g 11 ms 3 bumps / direction, 18 bumps in total Shock and vibration is tested in combination with DIN-Rails according to EN 60715 with a height of 15 mm and a thickness of 1.3 mm and standard orientation. | According to IEC 60068-2-27 |
| LABS compatibility | Yes | |
| Audible noise | Some audible noise may be emitted from the power supply during no load, overload or short circuit. | |

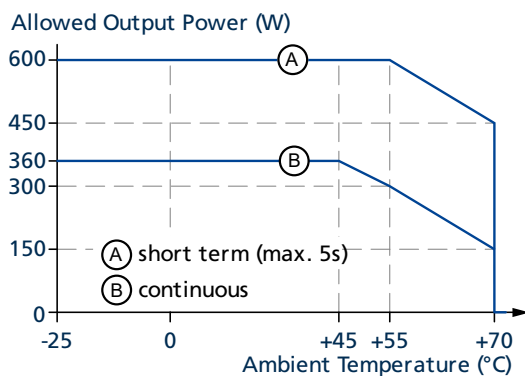

Fig. 16-1: Output power vs. ambient temp.

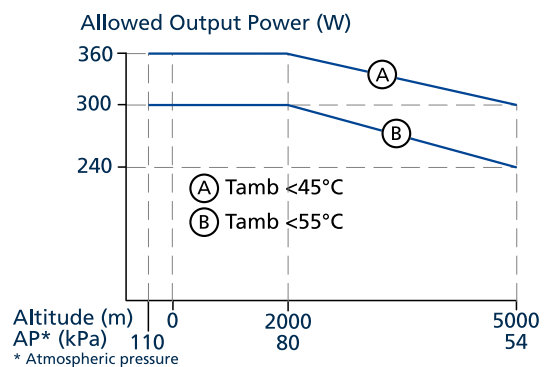

Fig. 16-2: Output power vs. altitude

All parameters are specified at 24 V, 12.5 A, 230 Vac, 25 °C ambient and after a 5 minutes run-in time unless otherwise noted.

17. Safety and Protection Features

| | | | |
|---------------------------------|------|----------------------------|---|
| Isolation resistance | min. | 500 MOhm | At delivered condition between input and output, measured with 500 Vdc |
| | min. | 500 MOhm | At delivered condition between input and PE, measured with 500 Vdc |
| PE resistance | max. | 0.1 Ohm | Resistance between PE terminal and the housing |
| Input/Output separation | | PELV | IEC/EN/UL 61010-2-201, IEC/EN 62368-1, IEC/EN 60950-1 |
| Output over-voltage protection | typ. | 31.8 Vdc | In case of an internal defect, a redundant circuit limits the maximum output voltage. The output shuts down and automatically attempts to restart |
| | max. | 32.5 Vdc | |
| Class of protection | | | According to IEC 61140 A PE (Protective Earth) connection is required |
| Ingress protection | | IP 65/67 | According to EN/IEC 60529 |
| Over-temperature protection | | Included | Output shut down with automatic restart. Temperature sensors are installed on critical components inside the unit and turns the unit off in safety critical situations, which can happen e.g. when ambient temperature is too high, ventilation is obstructed or the de-rating requirements are not followed. There is no correlation between the operating temperature and turn-off temperature since this is dependent on input voltage, load and installation methods. |
| Input transient protection | | MOV (Metal Oxide Varistor) | For protection values, see chapter 18, EMC. |
| Internal input fuse | | Included | Not user replaceable slow-blow high-breaking capacity fuse |
| Touch current (leakage current) | max. | 0.51 mA _{rms} | At 264Vac, 60Hz |

18. Dielectric Strength

The negative terminal of the outputs is permanently connected to PE within the unit. The output is insulated from the input by a double or reinforced insulation.

Type and routine tests are conducted by the manufacturer. Field tests may be conducted in the field using the appropriate test equipment which applies the voltage with a slow ramp (2s up and 2s down). Connect all input-terminals before conducting the test. When testing, set the cut-off current settings to the value in the table below.

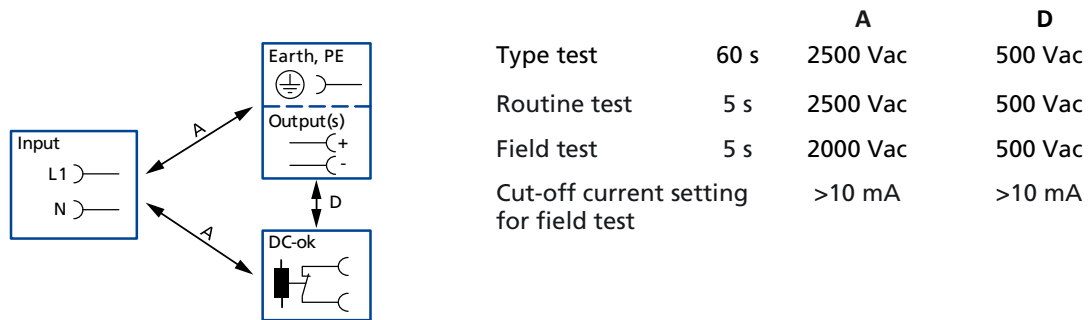



Fig. 18-1: Dielectric strength

19. Approvals and Fulfilled Standards

| | | |
|------------|---|---|
| IEC 62368 | CB Report | CB Scheme Certificate IEC 62368-1 - Audio/video, information and communication technology equipment - Safety requirements Output safety level: ES1 |
| IEC 61010 | Safety ✓ | CB Scheme Certificate IEC 61010-2-201 - Electrical Equipment for Measurement, Control and Laboratory Use - Particular requirements for control equipment |
| IEC 60950 | CB Report | Manufacturers Declaration IEC 60950-1 - General safety requirements for Information Technology Equipment (ITE) |
| UL 61010 |  | UL Certificate Listed equipment for category NMTR - UL 61010-2-201 - Electrical equipment for measurement, control and laboratory use - Particular requirements for control equipment Applicable for US and Canada E-File: E198865 |
| Semi F47 | SEMI F47 | Test Report Voltage Sag Immunity for Semiconductor Processing Equipment Tested for AC 208V L-L or L-N mains voltages, nominal output voltage and nominal output load |
| VDMA 24364 | LABS VDMA 24364-C1-L/W | Paint Wetting Impairment Substances Test (or LABS-Test) Tested for Zone 2 and test class C1 according to VDMA 24364-C1-L/W for solvents and water-based paints |

20. Regulatory Compliance

| | | |
|------------------------------|---|---|
| EU Declaration of Conformity |  | Trade conformity assessment for Europe The CE mark indicates conformance with the European - EMC directive - Low-voltage directive (LVD) - RoHS directive |
| WEEE Directive |  | Manufacturer's Statement EU-Directive on Waste Electrical and Electronic Equipment (WEEE) registered in Germany as business to business (B2B) products. WEEE-Reg.-Nr. DE 55837529 |
| REACH Regulation (EU) |  | Manufacturer's Statement EU regulation regarding the Registration, Evaluation, Authorization and Restriction of Chemicals (REACH) fulfilled. |
| China RoHS |  | Manufacturer's Statement The device meets the Measures for Restriction of the Use of Hazardous Substances in Electrical & Electronic Products according the China-RoHS requirements. The device is marked with EFUP symbol 25 years (Environmentally Friendly Use Period) |
| IEC/EN 61558-2-16 (Annex BB) | Safety Isolating Transformer | Safety Isolating Transformers corresponding to Part 2-6 of the IEC/EN 61558 |

All parameters are specified at 24 V, 12.5 A, 230 Vac, 25 °C ambient and after a 5 minutes run-in time unless otherwise noted.

21. Accessories

21.1. DIN RAIL Mounting KIT: ZM.FPDRA-11

In addition to screw mounting FIEPOS can easily be attached to a DIN rail using the ZM.FPDRA-11 DIN rail mounting kit.

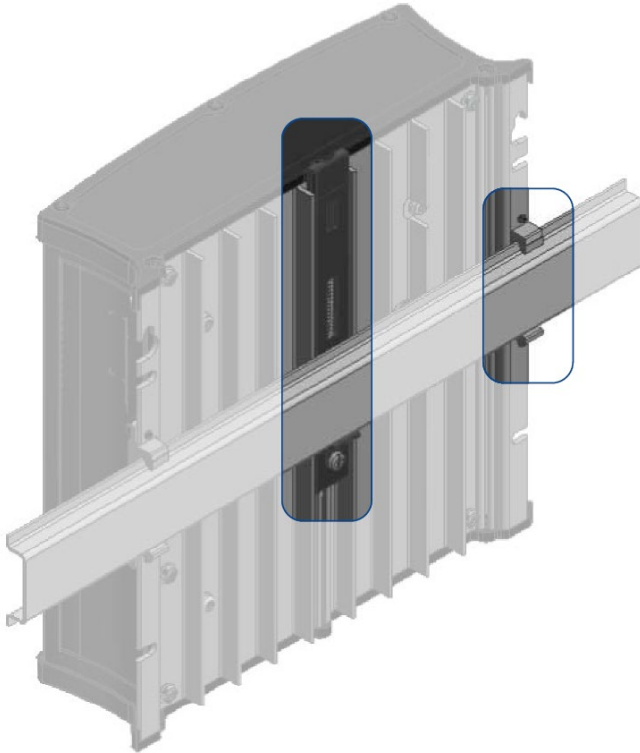

- DIN-Rail not included
- DIN-Fixture pre-assembled

21.2. Mounting Braket: ZM.FPMBA-11

In addition to screw mounting FIEPOS can easily be attached to a mounting bracket the ZM.FPMBA-11.

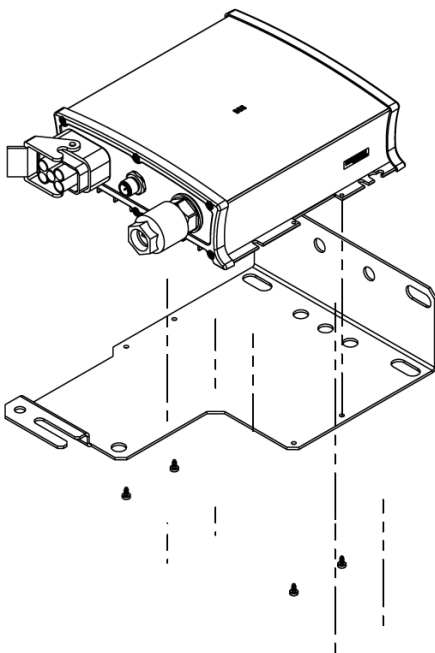

All parameters are specified at 24 V, 12.5 A, 230 Vac, 25 °C ambient and after a 5 minutes run-in time unless otherwise noted.

21.3. Connectors

FIEPOS features a large number of different connectors. Mating connectors can be ordered at PULS from stock in order to supply customers quickly during the design-in phase.

For a higher demand or other connector options go to [HARTING-PULS-cabling](#).

| Connector Name | PULS order code | Harting order code | Connector Description |
|-----------------|-----------------|--------------------|--|
| Harting HANQ4/2 | ZCF.hanq42 | 6104401263700 | Q4/2 Set AS female 2.5-6mm ² 7-13mm |
| Harting HANQ4/2 | ZCF.hanq42-1 | 6104401263800 | Q4/2 Set AS female 2.5-6mm ² 14-17mm |
| Harting HANQ2/0 | ZCM.hanq20 | 6104401263900 | Q2/0 Set screw male 2.5-6mm ² 6-12mm |
| Harting HANQ4/0 | ZCM.hanq40 | 6104401265100 | Q4/0 Set crimp 2,5mm ² IP67 |
| Harting HANQ5/0 | ZCF.hanq50 | 6104401265000 | Q5/0 Set QuickLock female 0.5-2.5mm ² 6-12mm |
| Harting M12-A | ZCF.m12a5p | 21032722505 | M12-A 5pin cut clamp female 0.34-0.5mm ² / 6-8mm |
| Harting M12-A | ZCM.m12a5p | 21032721505 | M12-A 5pin cut clamp male 0.34-0.5mm ² / 6-8mm |
| Harting M12-S | ZCF.m12s4p | 6102201020400 | M12-S 4pin screw female 2.5mm ² / 6-8mm |
| Harting M12-L | ZCM.m12l5p | 21032961505 | M12-L 5pin cut clamp male 0.75-1.5mm ² / 5.8-13.5mm |
| Harting M12-T | ZCM.m12t4p | 6102201021000 | M12-T 4pin screw male 1.5mm ² / 8-10mm |
| Harting 7/8" | ZCM.78inch4p | 6102201021100 | 7/8" 4pin screw male 1.5mm ² / 6-8mm |
| Harting 7/8" | ZCF.78inch3p | 6102201021200 | 7/8" 3pin screw female 1.5mm ² / 6-8mm |
| Harting 7/8" | ZCM.78inch5p | 21041162505 | 7/8" 5pin screw male 0.75-1.5mm ² / 6.8-12.5mm |

22. Related Products

The FIEPOS product family includes various devices with different technical parameters and features. The following page provides a general overview of the available solutions. Please also get in touch with your PULS contact person, for more detailed application advice and technical information.

FPS300.245-047-103:

Power Supply with four **fused channels** (2–10A) and IO-Link.



SHORT-FORM DATA

| | | |
|-------------------|--|-----------------------|
| Input voltage | 1AC 100-240 V | -15 / +10% |
| Output voltage | DC 24V | Nominal |
| Adjustment range | 24-28Vdc | Factory setting 24.5V |
| Output power | Continuous: | |
| | 360W | Up to +45°C ambient |
| | 300W | At +55°C ambient |
| | 150W | At +70°C ambient |
| | Short-term, up to 5s: | |
| | 600W | Below +55°C ambient |
| | 300W | At +70°C ambient |
| | Derate linearly between +55 °C to +70 °C | |
| Number of outputs | 4 | |
| Output current | Settable per output; up to 10A | |
| Input connector | 7/8" 3pin | |
| Output connector | 7/8" 4pin | |

FPT500.246-049-102:

Power Supply with three **NEC CLASS II** channels and IO-Link.



SHORT-FORM DATA

| | | |
|-------------------|--|-----------------------|
| Input voltage | 1AC 100-240 V | -15 / +10% |
| Output voltage | DC 24V | Nominal |
| Adjustment range | 24-28Vdc | Factory setting 24.5V |
| Output power | Continuous: | |
| | 360W | Up to +45°C ambient |
| | 300W | At +55°C ambient |
| | 150W | At +70°C ambient |
| | Short-term, up to 5s: | |
| | 600W | Below +55°C ambient |
| | 300W | At +70°C ambient |
| | Derate linearly between +55 °C to +70 °C | |
| Number of outputs | 3 | |
| Output current | NEC Class II | |
| Input connector | 7/8" 3pin | |
| Output connector | 7/8" 4pin | |

All parameters are specified at 24 V, 12.5 A, 230 Vac, 25 °C ambient and after a 5 minutes run-in time unless otherwise noted.

23. Application Notes

23.1. Repetitive Pulse Loading

Typically, a load current is not constant and varies over time. This power supply is designed to support loads with a higher short-term power demand (BonusPower). The short-term duration is hardware controlled by an output power manager and is available on a repeated basis. If the average load is higher than the sum of all output power, the output voltage will dip.

To avoid this, the following rules must be followed:

- a) The power demand of the pulse must be below 200 of the nominal output power.
- b) The duration of the pulse power must be shorter than the allowed BonusPower time, see chapter 6
- c) The average power should be lower than the nominal output power.

The R.M.S. output current must be below the specified continuous output current. If the R.M.S. current is higher, the unit may respond with a thermal shut-down after a period of time.

23.2. External Input Protection

The device is designed, tested and approved for branch circuits up to 20 A (UL) and 32 A (IEC) without additional protection device. If an external fuse is utilized, do not use circuit breakers smaller than 6 A B- or C-Characteristic to avoid a nuisance trip.

23.3. Inductive and Capacitive Loads

The unit is designed to supply any kind of loads, including capacitive and inductive loads. If extreme large capacitors, such as EDLCs (electric double layer capacitors or "UltraCaps") with a capacitance larger than 20mF are connected to the output, the unit might charge the capacitor or the output might trip, chapter 6.

23.4. Back Feeding Loads

Loads such as decelerating motors and inductors can feed voltage back to the power supply. This feature is also called return voltage immunity or resistance against Back- E.M.F. (Electro Magnetic Force).

This power supply is resistant and does not show malfunctioning when a load feeds back voltage to the power supply. It does not matter whether the power supply is on or off.

23.5. Mounting Orientations

The device can be mounted in various mounting orientations. The listed lifetime and MTBF values from this datasheet apply only for the standard mounting orientation. The following curves give an indication for allowed output power in different mounting orientations for altitudes up to 2000 m (6560 ft).

A

Standard Orientation

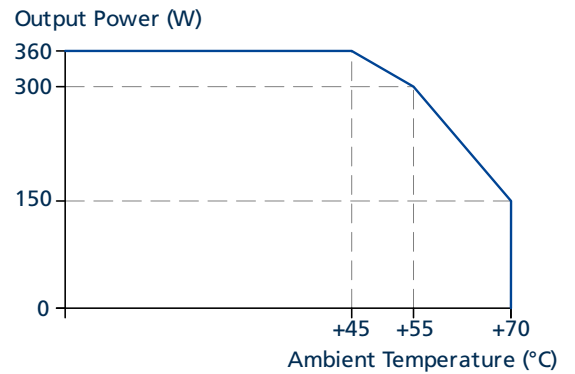
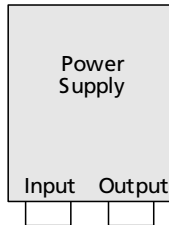

B

Upside down

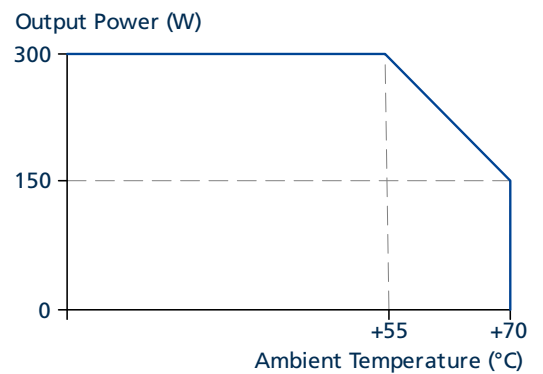
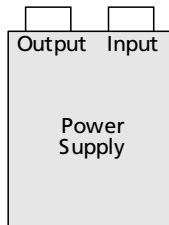

C

Horizontal
cw and ccw

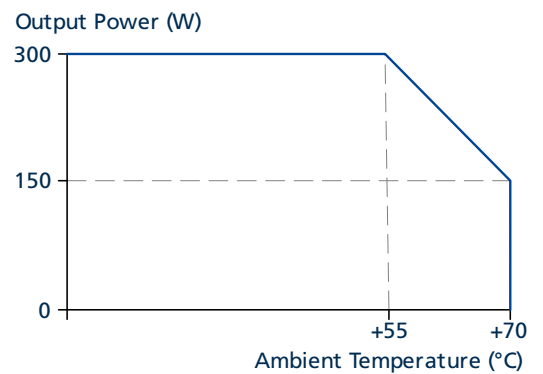

D

Over-head and
Table-top mounting

