



POWER SUPPLY 100-240 Vac 24 V 188 W

- IP65 and IP67 degree of protection
- AC 100-240 V wide-range input
- 2 independent output converters
- 2 NEC Class 2 outputs
- Output connected to PE (PELV/ES1)
- 95.1 % full load and excellent partial load efficiencies
- Full power between -30 °C and +45 °C
- Negligibly low input inrush current surge
- High immunity to transients and power surges
- Low electromagnetic emissions
- 3 year warranty

PRODUCT DESCRIPTION

The **FPS202** is an industrial grade power supply for a 1-phase mains system that is incorporated into a rugged wall-mount housing with an IP65 and IP67 degree of protection.

It provides 2 stabilised, galvanically isolated output channels, which are also electrically isolated from the input. The negative terminals of the outputs are permanently connected to PE within the unit.

The most outstanding features of the FPS series are compact size, wide operating temperature range, extremely low input inrush current and very high efficiencies, which are achieved through various design topologies.

High immunity to transients and power surges as well as low electromagnetic emissions and an international approval package make the use in nearly every application possible.

SHORT-FORM DATA

Output voltage	DC 24 V	nominal
Adjustment range	-	not adjustable
Total output power	188 W	for all outputs
Output power	2x 94 W	up to +45 °C ambient
	2x 60 W	up to +70 °C ambient
Short term (4 s)	2x 150 W	up to +45 °C ambient
	2x 90 W	up to +70 °C ambient
	Derate linearly between +45 °C to +70 °C	
Number of outputs	2	
Output currents	NEC Class 2	3.9 A
Input voltage AC	AC 100-240 V	-15 / +10 %
Power factor	0.98 / 0.96	at 120 / 230 Vac
AC Inrush current	8 / 4 A _{peak}	at 120 / 230 Vac
Efficiency	93.9 / 95.1 %	at 120 / 230 Vac
Power Losses	12.5 / 10 W	at 120 / 230 Vac
Hold-up time	38 / 38 ms	at 120 / 230 Vac
Temperature range	-30 °C to +70 °C	
Size (wxhxd)	166x153x59 mm	without connectors
Weight	790 g	

ORDER NUMBERS

FPS202.241-011	Power supply	
	Input	Output
	7/8" 3pin	7/8" 4pin

MAIN APPROVALS

For details and a complete approval list, see chapter 19.



IEC 62368-1
IEC 61010-2-201

UL 61010

1. Index

1	Index.....	2	16	Environment.....	15
2	Intended Use.....	4	17	Safety and Protection Features.....	16
3	Installation Instructions.....	4	18	Dielectric Strength.....	17
4	AC Input.....	5	19	Approved, Fulfilled or Tested Standards.....	18
5	DC Input.....	6	20	Regulatory Product Compliance.....	19
6	Input Inrush Current.....	6	21	Application Notes.....	20
7	Output.....	7	21.1	Repetitive Pulse Loading.....	20
8	Hold-up Time.....	8	21.2	External Input Protection.....	20
9	Efficiency and Power Losses.....	9	21.3	Inductive and Capacitive Loads.....	20
10	Lifetime Expectancy.....	10	21.4	Back-Feeding Loads.....	20
11	MTBF.....	10	21.5	Parallel Use to Increase Output Power.....	20
12	Functional Diagram.....	11	21.6	Series Operation.....	20
13	Dimensions and Connectors.....	12	21.7	Mounting Orientations.....	21
14	User Interface.....	13			
15	EMC.....	14			

The information given in this document is correct to the best of our knowledge and experience at the time of publication. If not expressly agreed otherwise, this information does not represent a warranty in the legal sense of the word. As the state of our knowledge and experience is constantly changing, the information in this datasheet is subject to revision. We therefore kindly ask you to always use the latest issue of this document (available under www.pulspower.com).

No part of this document may be reproduced or utilized in any form without our prior permission in writing.

Packaging and packaging aids can and should always be recycled. The product itself may not be disposed of as domestic refuse.

Terminology and Abbreviation

PE and \oplus Symbol	PE is the abbreviation for Protective Earth and has the same meaning as the symbol \oplus .
FE, Earth, Ground (GND)	This document uses the term "earth" which is the same as the U.S. term "ground".
t.b.d.	To be defined, value or description will follow later.
100 V	A figure displayed with the AC or DC before the value represents a nominal voltage with standard tolerances (usually $\pm 15\%$) included. E.g.: DC 12 V describes a 12 V battery disregarding whether it is full (13.7 V) or flat (10 V)
100 Vac	A figure with the unit (Vac) at the end is a momentary figure without any additional tolerances included.
50 Hz vs. 60 Hz	As long as not otherwise stated, AC 100 V and AC 230 V parameters are valid at 50 Hz mains frequency. AC 120 V parameters are valid for 60 Hz mains frequency.
may	A key word indicating flexibility of choice with no implied preference.
shall	A key word indicating a mandatory requirement.
should	A key word indicating flexibility of choice with a strongly preferred implementation.

Nomenclature

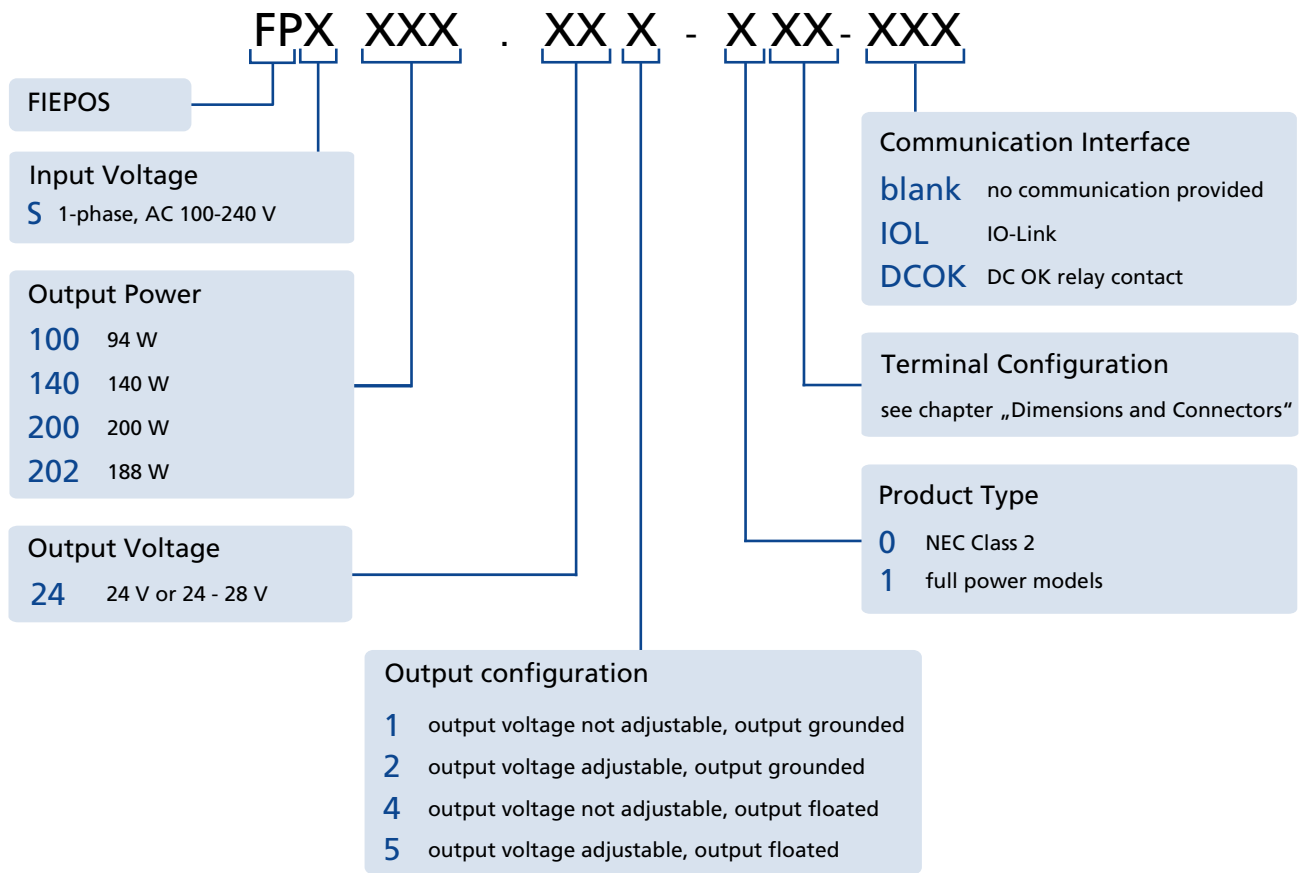

2. Intended Use

This device is designed for indoor use and is intended for commercial use, such as in industrial control, process control, monitoring and measurement equipment.

Do not use this device in equipment where malfunction may cause severe personal injury or threaten human life. If this device is used in a manner outside of its specification, the protection provided by the device may be impaired.

3. Installation Instructions

⚠ DANGER Risk of electrical shock, fire, personal injury or death

- Turn power off before working on the device. Protect against inadvertent re-powering.
- Do not open, modify or repair the device.
- Do not open the unit as high voltages are present inside.
- Do not touch during power-on and immediately after power-off. Hot surfaces may cause burns.
- Install the device on a large enough flat surface. Sharp edges on the back may cause injury.
- If damage or malfunction occur during installation or operation, immediately turn power off and send unit to the factory for inspection.
- The device is designed as “Class of Protection I” equipment according to IEC 61140. Do not use without a proper PE (Protective Earth) connection.

⚠ WARNING Risk of damages to the device

- Keep the following minimum installation clearances: 50 mm on top and 10 mm on the left and right side.
- The maximum surrounding air temperature is +70 °C. The operational temperature is the same as the ambient or surrounding air temperature and is defined 3 cm below the device.
- The device is designed to operate in areas between 5 % and 95 % relative humidity.
- Clean only with a damp cloth.

Obey the following installation instructions:

This device may only be installed and put into operation by qualified personnel. This device does not contain serviceable parts. The tripping of an internal input fuse is caused by an internal defect. Install the device onto a flat surface with the terminals on the bottom of the device. Other mounting orientations require a reduction in output power, see chapter Mounting Orientations.

For wall mounting use 4 screws. Two on top and 2 on bottom mounting holes. Recommended screw size is M4 (UNC 8-32). The enclosure of the device provides a degree of protection of IP65 and IP67 when installed with all mating connectors firmly connected. The device is designed for pollution degree 3 areas in controlled environments.

Assure that during installation no moisture or dirt gets into the connections. Operation in areas where moisture or condensation can be expected is possible.

The negative potential of the outputs is permanently connected to PE within the unit. Do not connect the negative potential of any output to PE outside the unit.

For TN-, TT-mains systems with earthed neutral and IT star mains systems with insulation monitoring the device is designed for overvoltage category III zones up to 2000 m and for overvoltage category II zones up to 5000 m.

For TN-, TT-, IT-delta mains systems or IT star mains systems without insulation monitoring the device is intended for overvoltage category II zones up to 2000 m.

The device is designed for altitudes up to 5000 m. Above 2000 m a reduction in output current is required and the operation is limited according mains systems described above. The device is designed, tested and approved for branch circuits up to 32 A (UL) and 32 A (IEC) without additional protection device. If an external fuse is utilized, do not use circuit breakers smaller than 6 A (type B- or C-characteristic) to avoid an unintentional tripping. A disconnecting means shall be provided for the input of the device. This must be suitably located and easily accessible. The disconnecting means must be marked as such for the device.

4. AC Input

The device is suitable to be supplied from TN-, TT- or IT-mains networks. For more details, see chapter 3.

AC input voltage rated range nom.	AC 100-240 V	-15 / +10 %
AC input operating range	85-264 Vac	
	264-310 Vac	for max. 1000 ms
Input frequency	nom. 50-60 Hz	±6 %
Turn-on voltage	typ. 83 Vac	steady-state value, see Fig. 4-1
Shut-down voltage	typ. 74 Vac	steady-state value, see Fig. 4-1
External input protection	see recommendations in chapter 3	

		AC 100 V	AC 120 V	AC 230 V	
Input current	typ.	2.1 A	1.75 A	0.92 A	at 2x 94 W, see Fig. 4-3
Power factor ¹⁾	typ.	0.98	0.98	0.96	at 2x 94 W, see Fig. 4-4
Start-up delay Output 1	typ.	1250 ms	1250 ms	1250 ms	at 2x 94 W, see Fig. 4-2
Start-up delay Output 2	typ.	1750 ms	1750 ms	1750 ms	
Rise time	typ.	15 ms	15 ms	15 ms	at 2x 94 W, const. current load, 0 mF, see Fig. 4-2
	typ.	35 ms	35 ms	35 ms	at 2x 94 W, const. current load, 3.3 mF, see Fig. 4-2
Turn-on overshoot	max.	200 mV	200 mV	200 mV	see Fig. 4-2

1) The power factor is the ratio of the true (or real) power to the apparent power in an AC circuit.

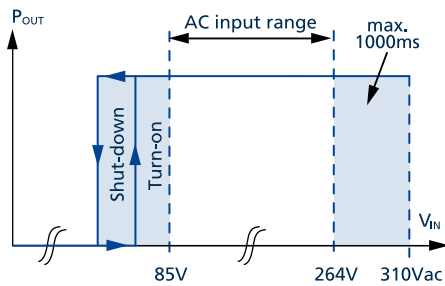

Fig. 4-1: Input voltage range

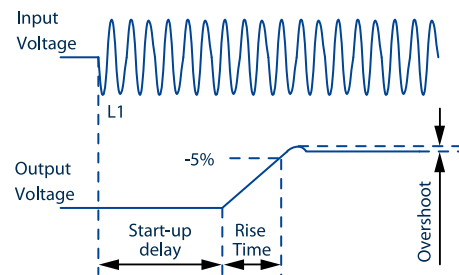

Fig. 4-2: Turn-on behaviour, definitions

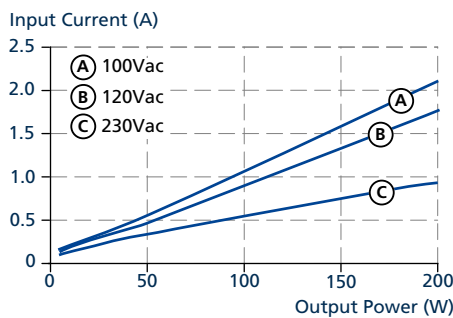

Fig. 4-3: Input current vs. output power at 24 V output voltage

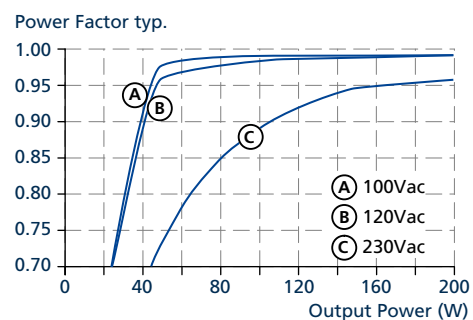

Fig. 4-4: Power factor vs. output power at 24 V output voltage

5. DC Input

Do not operate this power supply with DC input voltage.

6. Input Inrush Current

An active inrush limitation circuit (NTCs, which are bypassed by a relay contact) limits the input inrush current after turn-on of the input voltage. The charging current into EMI suppression capacitors is disregarded in the first microseconds after switch-on.

		AC 100 V	AC 120 V	AC 230 V
Inrush current	max.	9 A _{peak}	8 A _{peak}	4 A _{peak}

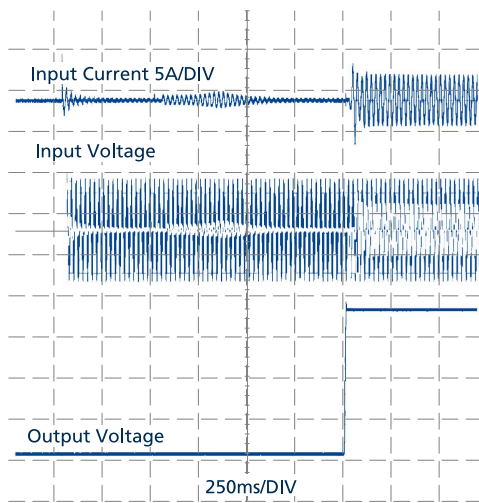

Fig. 6-1: Typical turn-on behaviour at nominal load and +25 °C ambient temperature

7. Output

The outputs provide a (PELV/ES1) rated voltage, which is galvanically isolated from the input voltage. The negative potential of the outputs is permanently connected to PE within the unit. Do not connect any output to PE (Ground).

The device is designed to supply any kind of loads, including capacitive and inductive loads. If capacitors with a capacitance > 100 mF are connected to the output, the unit might charge the capacitor in overcurrent mode.

All values provided in this chapter are specified per output unless stated otherwise.

Number of outputs		2	2 independent output converters
Output voltage	nom.	24 V	
Adjustment range		-	not adjustable
Factory settings	typ.	24 V	±1 %
Line regulation	max.	10 mV	between 85 and 310 Vac input voltage change
Load regulation	max.	50 mV	between 0 and 2x 94 W output load, static value
Ripple and noise voltage	max.	60 mVpp	bandwidth 20 Hz to 20 MHz, 50 Ohm
Output current		NEC Class 2	3.9 A
Output power	nom.	188 W	up to +45 °C ambient temperature
	nom.	60 W	up to +70 °C ambient temperature
Short term up to 4 s	nom.	150 W	up to +45 °C ambient temperature
	nom.	90 W	up to +70 °C ambient temperature
		Derate linearly between +45 °C and +70 °C, see Fig. 16-1.	
Overload / short-circuit current	typ.	7.5 A / 0 A	At heavy overloads (when output voltage falls below 13 V), the power supply delivers continuous output current for 2 s. After this, the output is switched off for approx. 18 s before a new start attempt is automatically performed. This cycle is repeated as long as the overload exists. Once the overload has been cleared, the device will operate normally, see Fig. 7-2. Load impedance 10 mOhm. Discharge current of output capacitors is not included.
Output capacitance	typ.	1 760 µF	included inside the power supply
Back-feeding loads	max.	35 V / 0.5 J	The unit is resistant and does not show a malfunction when a load feeds back voltage to the power supply. It does not matter whether the power supply is on or off.

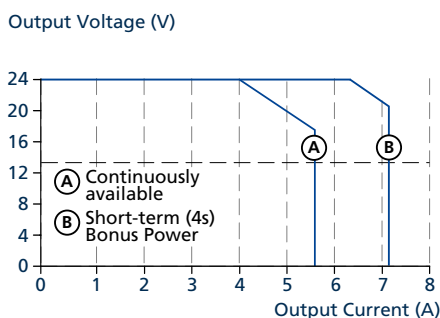

Fig. 7-1: Output voltage vs. output current

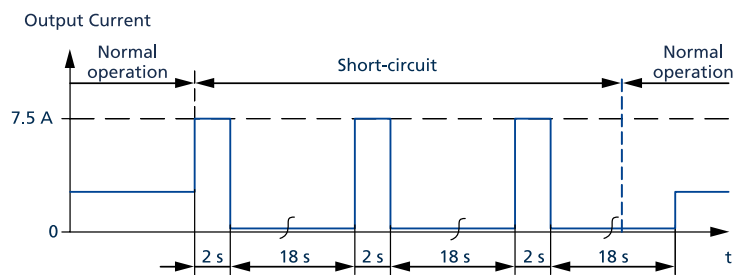

Fig. 7-2: Short-circuit on output, overcurrent mode, typ.

8. Hold-up Time

The hold-up time is the time during which a power supply's output voltage remains within specification following the loss of input power. The hold-up time is output load dependent. At no load, the hold-up time can be up to several seconds. The LED is also on during this time.

		AC 100 V	AC 120 V	AC 230 V	
Hold-up time	typ.	61 ms	61 ms	61 ms	at 2x 50 W output load, see Fig. 8-1
	min.	50 ms	50 ms	50 ms	at 2x 50 W output load, see Fig. 8-1
	typ.	38 ms	38 ms	38 ms	at 2x 94 W output load, see Fig. 8-1
	min.	25 ms	25 ms	25 ms	at 2x 94 W output load, see Fig. 8-1

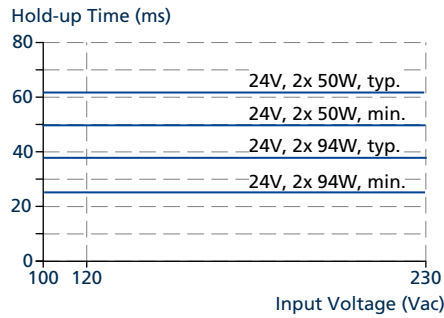

Fig. 8-1: Hold-up time vs. input voltage

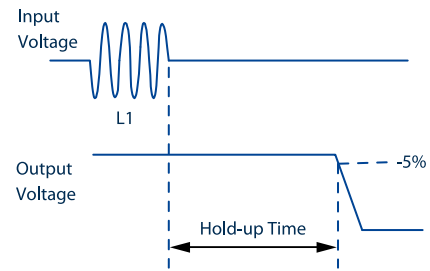

Fig. 8-2: Shut-down behaviour, definitions

9. Efficiency and Power Losses

		AC 100 V	AC 120 V	AC 230 V	
Efficiency	typ.	93.2 %	93.9 %	95.1 %	at 24 V, 2x 94 W
Average efficiency ¹⁾	typ.	92.5 %	93.0 %	94.1 %	25 % at 2x 25 W, 25 % at 2x 50 W, 25 % at 2x 75 W, 25 % at 2x 94 W
Power losses	typ.	2.7 W	2.7 W	2.7 W	at 24 V, 0 W
	typ.	7.9 W	7.5 W	6.2 W	at 24 V, 2x 50 W
	typ.	13.9 W	12.5 W	10 W	at 24 V, 2x 94 W

1) The average efficiency is an assumption for a typical application where the power supply is loaded with 25 % of the nominal load for 25 % of the time, 50 % of the nominal load for another 25 % of the time, 75 % of the nominal load for another 25 % of the time and with 100 % of the nominal load for the rest of the time.

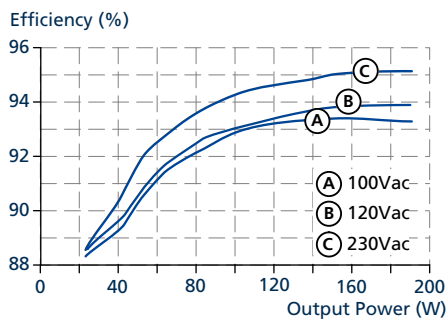

Fig. 9-1: Efficiency vs. output power at 24 V, typ.

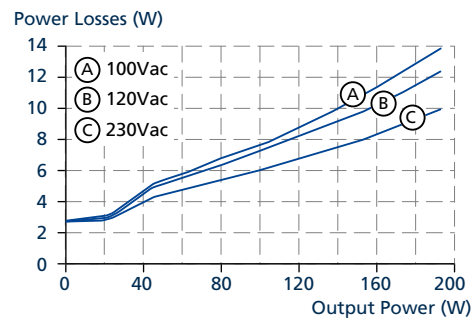

Fig. 9-2: Losses vs. output power at 24 V, typ.

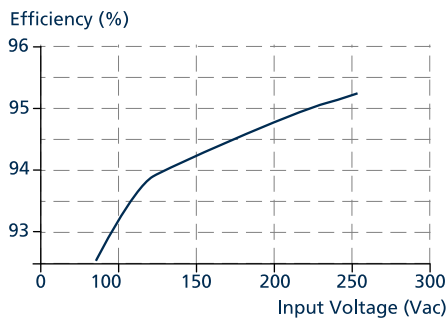

Fig. 9-3: Efficiency vs. input voltage at 24 V, 188 W, typ.

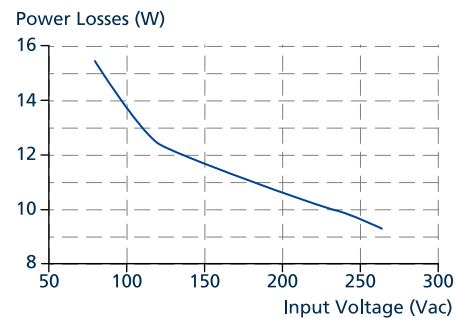

Fig. 9-4: Losses vs. input voltage at 24 V, 188 W, typ.

10. Lifetime Expectancy

The lifetime expectancy shown in the table indicates the minimum operating hours (service lifetime) and is determined by the lifetime expectancy of the built-in electrolytic capacitors. Lifetime expectancy is specified in operational hours and is calculated according to the capacitor's manufacturer specification. The manufacturer of the electrolytic capacitors only guarantees a maximum lifetime of up to 15 years (131 400 h). Any number exceeding this value is a calculated theoretical lifetime, which can be used to compare devices.

	AC 100 V	AC 120 V	AC 230 V	
Calculated lifetime expectancy	130 400 h	142 100 h	206 000 h	at 24 V, 2x 94 W and +25 °C
	609 200 h	625 900 h	714 500 h	at 24 V, 2x 50 W and +25 °C

11. MTBF

MTBF stands for **Mean Time Between Failures**, which is calculated according to statistical device failures, and indicates reliability of a device. It is the statistical representation of the likelihood of a unit to fail and does not necessarily represent the lifetime of a product.

An MTBF figure of e.g. 1 000 000 h means that statistically one unit out of 10 000 installed units will fail every 100 h. However, it can not be determined if the failed unit has been running for 50 000 h or only for 100 h.

For these types of units the MTTF (**Mean Time To Failures**) value is the same value as the MTBF value.

	AC 100 V	AC 120 V	AC 230 V	
MTBF SN 29500, IEC 61709	772 000 h	899 000 h	1 092 000 h	at 24 V, 2x 94 W and +25 °C
MTBF MIL HDBK 217F	244 000 h	272 000 h	314 000 h	at 24 V, 2x 94 W and +25 °C; Ground Benign GB25
	60 000 h	66 000 h	75 000 h	at 24 V, 2x 94 W and +25 °C; Ground Fixed GF25

12. Functional Diagram

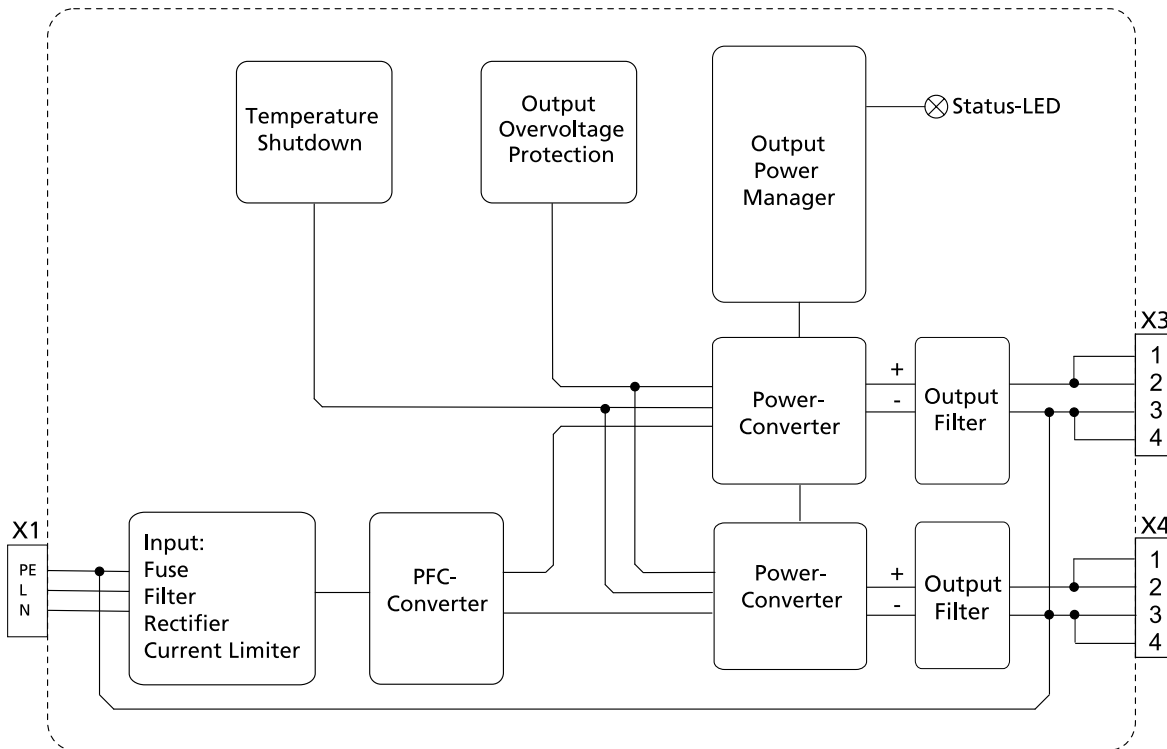
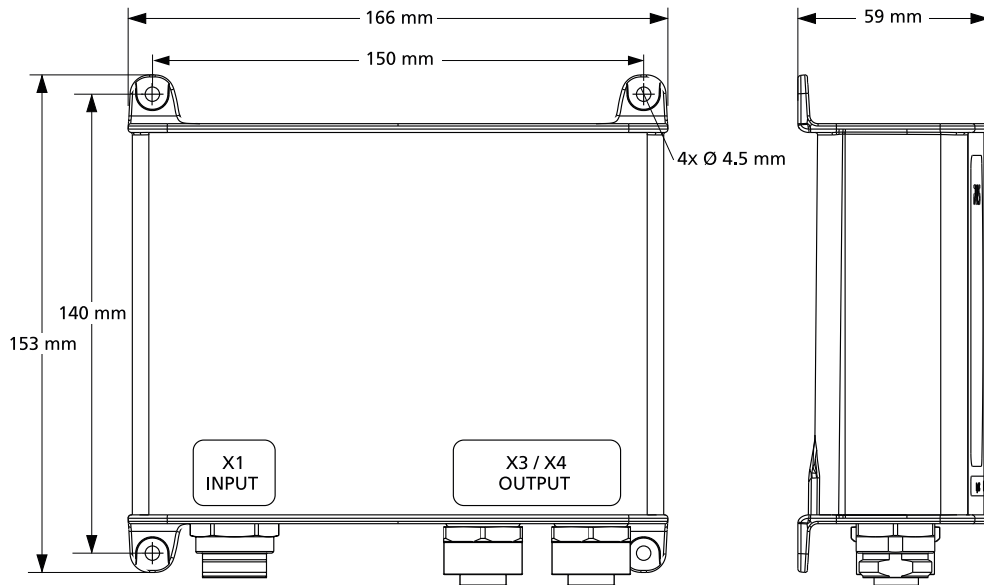

Fig. 12-1: Functional Diagram FPS202.241-011

13. Dimensions and Connectors



Width: 166 mm
 Height: 153 mm
 Depth: 59 mm
 Weight: 790 g

Housing body material: Hi-grade polycarbonate
 Housing cover material: Hi-grade polycarbonate
 Installation clearances: 50 mm on top, 10 mm on the left and right side

NOTE

Ensure adequate clearance below the device for mating connectors and cables.

Input connector on power supply (X1):

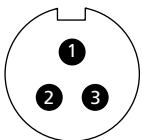

7/8" 3pin male

Pin 1: PE connection \oplus
 Pin 2: L
 Pin 3: N

Output connector on power supply (X3, X4):

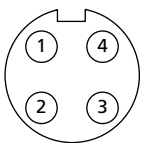

7/8" 4pin female

Pin 1: 24 Vdc
 Pin 2: 24 Vdc
 Pin 3: GND
 Pin 4: GND

14. User Interface

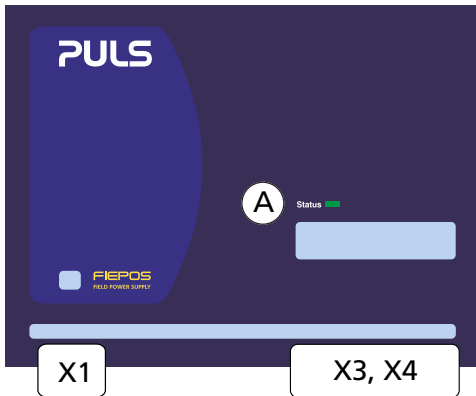

X1	Input connector
X3, X4	Output connector
A	Status LED

LED signaling

The Status LED (A) displays different running conditions of the device in real-time.

- Green: Output On**
 The DC output voltage is above 90 % of the set-point voltage and all outputs are operating according to their settings.
- Off**
 The DC output voltage is below 90 % of the set-point voltage, at least one output converter has tripped or the power supply is not powered.

15. EMC

The EMC behaviour of the device is designed for applications in industrial environment as well as in residential, commercial and light industry environments.

The device is investigated according to EN 61000-6-1, EN 61000-6-2, EN 61000-6-3, EN 61000-6-4, EN 61000-3-2 and EN 61000-3-3.

EMC Immunity

Electrostatic discharge	EN 61000-4-2	contact discharge	8 kV	Criterion A
Air discharge		air discharge	15 kV	Criterion A
Electromagnetic RF field	EN 61000-4-3	80 MHz - 1 GHz	20 V/m	Criterion A
		1 GHz - 6 GHz	10 V/m	Criterion A
Fast transients (Burst)	EN 61000-4-4	AC input lines	4 kV	Criterion A
		DC output lines	2 kV	Criterion A
Surge voltage on AC input	EN 61000-4-5	L → N	2 kV	Criterion A
		L / N → PE	4 kV	Criterion A
Surge voltage on DC output	EN 61000-4-5	(+) → (-)	1 kV	Criterion A
		(+) / (-) → PE	2 kV	Criterion A
Conducted immunity	EN 61000-4-6	AC input	20 V	Criterion A
		DC output	20 V	Criterion A
Voltage dips	EN 61000-4-11	0 % of 100 Vac	0 Vac, 20 ms	Criterion A
		40 % of 100 Vac	40 Vac, 200 ms	Criterion C
		70 % of 100 Vac	70 Vac, 500 ms	Criterion C
	EN 61000-4-11	0 % of 200 Vac	0 Vac, 20 ms	Criterion A
		40 % of 200 Vac	80 Vac, 200 ms	Criterion A
		70 % of 200 Vac	140 Vac, 500 ms	Criterion A
Voltage interruptions	EN 61000-4-11	0 % of 200 Vac	0 Vac, 5000 ms	Criterion C
Voltage sags	SEMI F47	dips on the input voltage according to SEMI F47 standard		
		80 % of 208 Vac	166 Vac, 1000 ms	Criterion A
		70 % of 208 Vac	145 Vac, 500 ms	Criterion A
		50 % of 208 Vac	104 Vac, 200 ms	Criterion A
Powerful transients	VDE 0160	over entire load range	750 V, 0.3 ms	Criterion A

Performance criterions:

A: The device shows normal operation behavior within the defined limits.

C: Temporary loss of function is possible. The device may shut down and restart by itself. No damage or hazards for the device will occur.

EMC Emission

Conducted emission AC input lines	EN IEC 61000-6-3, EN 55032, Class B EN 55011
Conducted emission DC output lines	EN IEC 61000-6-3
Radiated emission	EN IEC 61000-6-3, EN 55032, Class B EN 55011
Harmonics	EN 61000-3-2 pass for Class A equipment
Voltage fluctuations, flicker	EN 61000-3-3 pass tested with constant current loads, non pulsing

This device complies with FCC Part 15 rules.

Operation is subjected to following two conditions: (1) this device may not cause harmful interference, and (2) this device must accept any interference received, including interference that may cause undesired operation.

Switching Frequencies

PFC converter	20 kHz to 135 kHz	input voltage and output load dependent
Main converter	60 kHz to 140 kHz	output load dependent
Auxiliary converter	54 kHz to 66 kHz	output load dependent
Microcontroller clocks	48 MHz and 32 MHz	fixed frequency

All parameters are specified at 24 V, 188 W, 230 Vac, +25 °C ambient and after a 5 minutes run-in time unless otherwise noted.

16. Environment

Operational temperature	-30 °C to +70 °C	Operational temperature is the same as the ambient or surrounding temperature and is defined as the air temperature 3 cm below the unit.
Storage temperature	-40 °C to +85 °C	for storage and transportation
Output derating	2.8 W / °C 20 W / 1000 m or 5 °C / 1000 m for altitudes > 2000 m, see Fig. 16-2 The derating is not hardware controlled. The application has to stay below the derated current limits in order not to overload the unit.	between +45 °C and +70 °C, see Fig. 16-1
Humidity	5-95 % r.h.	according to IEC 60068-2-30
Atmospheric pressure	54-110 kPa	see Fig. 16-2
Altitude	up to 5000 m	see Fig. 16-2
Overvoltage category	III	according to IEC 60664-1 for TN-, TT-mains systems with earthed neutral and IT star mains systems with insulation monitoring for altitudes up to 2000 m
	II	according to IEC 60664-1 for TN-, TT-mains systems with earthed neutral and IT star mains systems with insulation monitoring for altitudes between 2000 m and 5000 m according to IEC 60664-1 for TN-, TT-, IT-delta mains systems or IT star mains systems without insulation monitoring for altitudes up to 2000 m
Degree of pollution	2	according to IEC/UL 61010-1
Vibration sinusoidal	2-17.8 Hz: ±1.6 mm; 17.8-500 Hz: 2 g 2 hours / axis	according to IEC 60068-2-6
Shock	30 g 6 ms, 20 g 11 ms 3 bumps / direction, 18 bumps in total	according to IEC 60068-2-27
Audible noise	Some audible noise may be emitted from the power supply during no load, overload or short-circuit.	

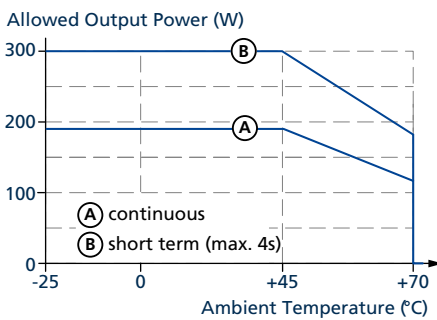

Fig. 16-1: Output power vs. ambient temp.

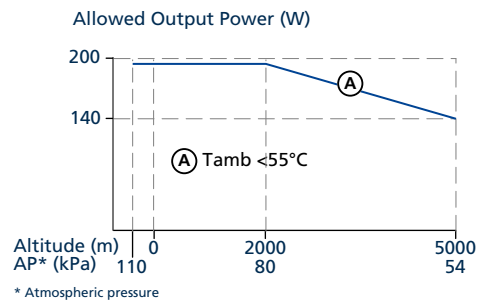

Fig. 16-2: Output power vs. altitude

17. Safety and Protection Features

Isolation resistance	min.	500 MOhm	at delivered condition between input and output, measured with 500 Vdc
	min.	500 MOhm	at delivered condition between input and PE, measured with 500 Vdc
PE resistance	max.	0.1 Ohm	resistance between PE terminal and housing
Input / Output separation		PELV/ES1	IEC/EN/UL 61010-2-201, IEC/EN 62368-1, IEC/EN 60950-1
Output overvoltage protection	typ.	31.8 Vdc	
	max.	32.5 Vdc	In case of an internal defect, a redundant circuit limits the maximum output voltage. The output shuts down and automatically attempts to restart.
Class of protection		I	according to IEC 61140 a PE (Protective Earth) connection is required
Degree of protection		IP65 and IP67	according to EN/IEC 60529
Overtemperature protection		included	Output shut down with automatic restart. Temperature sensors are installed on critical components inside the unit and the unit turns off in safety critical situations, which can happen, e.g. when ambient temperature is too high, ventilation is obstructed or the derating requirements are not followed. There is no correlation between the operating temperature and turn-off temperature since this is dependent on input voltage, load and installation methods.
Input transient protection		MOV (Metal Oxide Varistor)	for protection values, see chapter 15.
Internal input fuse		included	not user replaceable slow-blow high-breaking capacity fuse, 6.3 A (T)
PE conductor current	max.	0.49 mA _{rms}	at 264 Vac, 60 Hz, TN-,TT-mains / IT-mains

18. Dielectric Strength

The negative terminals of the outputs are permanently connected to PE within the unit. The output is separated from the input by a double or reinforced insulation.

Type and routine tests are conducted by the manufacturer. Field tests may be conducted in the field using the appropriate test equipment which applies the voltage with a slow ramp (2 s up and 2 s down). Connect all input terminals before conducting the test. When testing, set the cut-off current settings to the value in the table below.

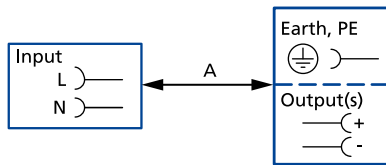





		A
Type test	60 s	2500 Vac
Routine test	5 s	2500 Vac
Field test	5 s	2000 Vac
Cut-off current setting for field test		> 10 mA

19. Approved, Fulfilled or Tested Standards

IEC 62368	CB Report	CB Scheme Certificate IEC 62368-1 - Audio / video, information and communication technology equipment - Safety requirements Output safety level: ES1
IEC 61010	CB Report	CB Scheme Certificate IEC 61010-2-201 - Electrical Equipment for Measurement, Control and Laboratory Use - Particular requirements for control equipment
IEC 60950	Safety ✓	Manufacturers Declaration IEC 60950-1 – General safety requirements for Information Technology Equipment (ITE)
UL 61010		UL Certificate Listed equipment for category NMTR - UL 61010-2-201 - Electrical equipment for measurement, control and laboratory use - Particular requirements for control equipment Applicable for US and Canada E-File: E198865
NEC Class 2	NEC CLASS 2	UL Certificate Limited Power Source Listed in the UL 61010-2-201 approval report, investigated according to UL 1310
Semi F47	SEMI F47	Test Report Voltage Sag Immunity for Semiconductor Processing Equipment Tested for AC 208 V L-L or L-N mains voltages, nominal output voltage and nominal output load
VDMA 24364	LABS VDMA 24364-C1-L/W	Paint Wetting Impairment Substances Test (or LABS-Test) Tested for Zone 2 and Test Class C1 according to VDMA 24364-C1-L/W for solvents and water-based paints

20. Regulatory Product Compliance

EU Declaration of Conformity		<p>The CE mark indicates conformance with the European</p> <ul style="list-style-type: none"> - EMC directive - Low-voltage directive (LVD) - RoHS directive
WEEE Directive		<p>Manufacturer's Declaration EU-Directive on Waste Electrical and Electronic Equipment (WEEE) registered in Germany as business to business (B2B) products. WEEE-Reg.-Nr. DE 55837529</p>
REACH Regulation (EU)		<p>Manufacturer's Statement EU regulation regarding the Registration, Evaluation, Authorisation and Restriction of Chemicals (REACH) fulfilled.</p>
RoHS-China		<p>Manufacturer's Statement Administrative Measures for the Restriction of the Use of Hazardous Substances in Electrical and Electronic Products 25 years</p>
IEC/EN 61558-2-16 (Annex BB)	Safety Isolating Transformer	Safety Isolating Transformers corresponding to Part 2-6 of the IEC/EN 61558

21. Application Notes

21.1. Repetitive Pulse Loading

Typically, a load current is not constant and varies over time. This power supply is designed to support loads with a higher short-term power demand. The short-term duration is hardware controlled by an output power manager and is available on a repeated basis. If the average load is higher than the rated output power, the output voltage will dip.

To avoid this, the following rules must be followed:

- a) The power demand of the pulse must be below 200 % of the nominal output power.
- b) The duration of the pulse power must be shorter than the allowed short-term power time, see chapter 7.
- c) The average power should be lower than the nominal output power.

The R.M.S. output current must be below the specified continuous output current. If the R.M.S. current is higher, the unit may respond with a thermal shut-down after a period of time.

21.2. External Input Protection

The device is designed, tested and approved for branch circuits up to 32 A (UL) and 32 A (IEC) without an additional protection device. If an external device (fuse or circuit breaker) is utilized, do not use fuses or circuit breaker smaller than 6 A (type B- or C-characteristic) to avoid an unintentional tripping.

21.3. Inductive and Capacitive Loads

The power supply is designed to supply any kind of loads, including capacitive and inductive loads. If extreme large capacitors, such as EDLCs (electric double layer capacitors or "UltraCaps") with a capacitance larger than 100 mF are connected to the output, the power supply might charge the capacitor or the output might trip, see chapter 7.

21.4. Back-Feeding Loads

Loads such as decelerating motors and inductors can feed voltage back to the power supply. This feature is also called return voltage immunity or resistance against Back-E.M.F. (Electro **M**agnetic **F**orce).

This power supply is resistant and does not show malfunctioning when a load feeds back voltage to the power supply below 35 V / 0.5 J. It does not matter whether the power supply is on or off.

21.5. Parallel Use to Increase Output Power

Do not use parallel outputs or devices for higher output currents.

21.6. Series Operation

Do not connect power supplies in series.

21.7. Mounting Orientations

The device can be panel mounted in various mounting orientations. The listed lifetime and MTBF values from this datasheet apply only for the standard mounting orientation. The following curves give an indication for allowed output power in different mounting orientations for altitudes up to 2000 m.

A
Standard orientation

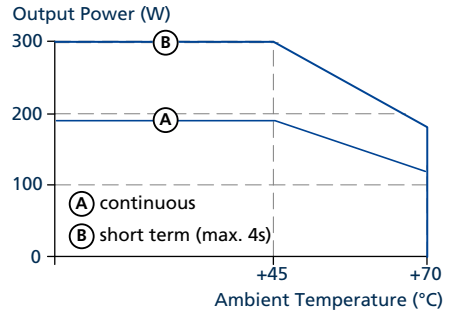
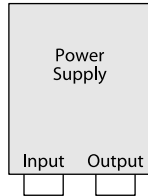

B
Upside down

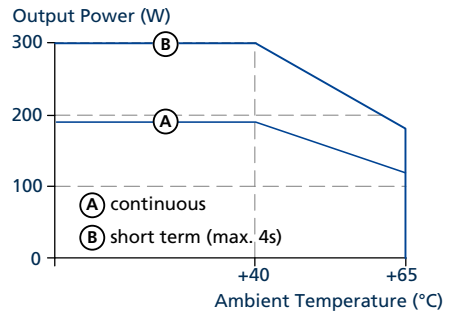
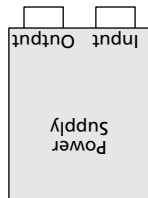

C
Horizontal clockwise
and counter clockwise

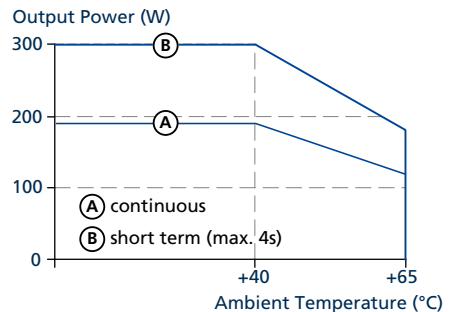

D
Overhead and tabletop
mounting

