

POWER SUPPLY

3AC 24V 300W

- IP54 degree of protection
- 450W continuously for 60s
- 600W_{peak} 1s
- 3AC 380-480V wide-range input
- 95.2% full load and excellent partial load efficiencies
- DIN rail mounting possible, option “D”
- Output connected to PE (PELV)
- Version without connection to PE on request
- Large output capacitors
- Not potted
- Negligible low input inrush current surge
- Full power between -25°C and +55°C
- DC-OK relay contact
- 3 Years Warranty

GENERAL DESCRIPTION

The **FPT300** is an industrial grade power supply for the single-phase mains system incorporated in a rugged wall-mount housing with a degree of protection IP54.

It provides one floating, stabilized SELV/PELV output, which is galvanically separated from the input. In case of an overload or load failure, the output offers hiccup-mode.

The most outstanding features of the FPT series are the compact size, the wide operational temperature range, the low input inrush current and the extremely high efficiencies, which are achieved by various technological design technologies.

Various connector options support the different needs of individual applications. Please contact PULS for possible options.

High immunity to transients and power surges as well as low electromagnetic emission and an international approval package makes usage in nearly every environment possible.

SHORT-FORM DATA

Output voltage	DC 24V	0%/+6%
Adjustment range	-	Not adjustable
Output power	Continuous: 300 / 150W	Up to: +55 / +70°C
	Short term up to 450W / 60s	+55°C
	600W / 1s	+55°C
Input voltage AC	3AC 380-480V	±15%
Power factor	0.9 / 0.9	At 3x400 / 480Vac
AC Inrush current	1.5 / 1.5A _{peak}	At 3x400 / 480Vac
Efficiency	95.2 / 95.0%	At 3x400 / 480Vac
Losses	15.1 / 15.8 W	At 3x400 / 480Vac
Hold-up time	25 / 25ms	At 120 / 230Vac
Temperature range	-25°C to +70°C	Derate linearly from +55°C to +70°C
Size (wxhxd)	182x272x70mm	Without connectors
Weight	1550g / 3.4lb	

ORDER NUMBERS

Description:	Power supply FPT300	
Order Number	Input	Output
FPT300.242-008-102	HanQ4/2	QuickON

Accessories:	Chapter 21
Related Products	Chapter 22

MAIN APPROVALS

For details or an complete approval (pending) list, see chapter 19.



Index



1. Intended Use	3	18. Dielectric Strength.....	18
2. Installation Instructions.....	3	19. Approvals And Fulfilled Standards.....	19
3. AC-Input	4	20. Regulatory Compliance.....	19
4. DC-Input	5	21. Accessories	20
5. Input Inrush Current.....	5	21.1. DIN RAIL Mounting KIT: ZM.FP-DIN2	20
6. Output.....	6	21.2. Connectors	20
7. Hold-up Time	8	22. Related Products.....	21
8. DC-OK Relay Contact	8	23. Application Notes.....	22
9. Efficiency And Power Losses	9	23.1. Repetitive Pulse Loading.....	22
10. Lifetime Expectancy	10	23.2. External Input Protection.....	22
11. MTBF	10	23.3. Inductive and Capacitive Loads.....	22
12. Functional Diagram	11	23.4. Two Phases Operation.....	22
13. Dimensions And Connector Variants.....	12	23.5. Back Feeding Loads	23
14. User Interface	14	23.6. Mounting Orientations.....	23
15. EMC.....	15		
16. Environment	16		
17. Safety And Protection Features	17		

The information given in this document is correct to the best of our knowledge and experience at the time of publication. If not expressly agreed otherwise, this information does not represent a warranty in the legal sense of the word. As the state of our knowledge and experience is constantly changing, the information in this data sheet is subject to revision. We therefore kindly ask you to always use the latest issue of this document (available under www.pulspower.com).

No part of this document may be reproduced or utilized in any form without our prior permission in writing.

Packaging and packaging aids can and should always be recycled. The product itself may not be disposed of as domestic refuse.

TERMINOLOGY AND ABBREVIATIONS

PE and  Symbol	PE is the abbreviation for Protective Earth and has the same meaning as the symbol  .
Earth, Ground	This document uses the term “earth” which is the same as the U.S. term “ground”.
T.b.d.	To be defined, value or description will follow later.
3AC 400V	A figure displayed with the AC or DC before the value represents a nominal voltage with tolerances (usually $\pm 15\%$) included. E.g.: DC 12V describes a 12V battery disregarding whether it is full (13.7V) or flat (10V)
3x 400Vac	A figure with the unit (Vac) at the end is a momentary figure without any additional tolerances included.
50Hz vs. 60Hz	As long as not otherwise stated, 3AC 400V parameters are valid at 50Hz mains frequency.
may	A key word indicating flexibility of choice with no implied preference.
shall	A key word indicating a mandatory requirement.
should	A key word indicating flexibility of choice with a strongly preferred implementation.

1. Intended Use

This device is designed for indoor use and is intended for commercial applications, such as in industrial control, process control, monitoring and measurement equipment or the like.

Do not use this device in equipment where malfunction may cause severe personal injury or threaten human life. If this device is used in a manner outside of its specification, the protection provided by the device may be impaired.

2. Installation Instructions

DANGER

Risk of electrical shock, fire, personal injury or death.

- Turn power off before working on the device. Protect against inadvertent re-powering.
- Do not open, modify or repair the device.
- Do not use in wet locations or in areas where moisture or condensation can be expected.
- Do not touch during power-on and immediately after power-off. Hot surfaces may cause burns.
- Install the device on a large enough flat surface. Sharp edges on the back may cause injury.
- If damages or malfunctioning occur during installation or operation, immediately turn power off and send unit to the factory for inspection.
- The device is designed as “Class of Protection I” equipment according to IEC 61140. Do not use without a proper PE (Protective Earth) connection.

WARNING

Risk of damages on the device

- Keep the following minimum installation clearances: 0mm on top, 30mm on the bottom, 15mm on the front and 10mm on left and right side.
- The maximum surrounding air temperature is +70°C (+158°F). The operational temperature is the same as the ambient or surrounding air temperature and is defined 2cm below the device.
- The device is designed to operate in areas between 5% and 95% relative humidity.
- Clean only with a damp cloth.

Obey the following installation instructions:

This device may only be installed and put into operation by qualified personnel. This device does not contain serviceable parts. The tripping of an internal fuse is caused by an internal defect. Install the device onto a flat surface with the terminals on the bottom of the device. Other mounting orientations require a reduction in output power, chapter 23.6.

For wall mounting use 4 screws. Two on top and 2 on bottom mounting holes. Recommended screw size is M4 (UNC 8-32). The enclosure of the device provides a degree of protection of IP54 when installed with all mating connectors firmly connected. The device is designed for pollution degree 2 areas in controlled environments.

The negative potential of the outputs is permanently connected to PE within the unit. Do not connect the negative potential of any output to PE outside the unit.

For TN, TT mains systems with earthed neutral and IT star mains systems with insulation monitoring the device is designed for overvoltage category III zones up to 2000m (6560ft) and for overvoltage category II zones up to 5000m (16400ft).

For TN, TT, IT delta mains systems or IT star mains systems without insulation monitoring the device is intended for overvoltage category II zones up to 2000m (6560ft). The device is designed to be safe in case of a single phase loss and does not require an external protection. Functionality is limited see chapter 23.4.

The device is designed for altitudes up to 5000m (16400ft). Above 2000m (6560ft) a reduction in output current is required and the operation is limited according mains systems described above. The device is designed, tested and approved for branch circuits up to 20A (UL) and 32A (IEC) without additional protection device. If an external fuse is utilized, do not use circuit breakers smaller than 6A B- or C-characteristic to avoid a nuisance trip. A disconnecting means shall be provided for the input of the device. This must be suitably located and easily accessible. The disconnecting means must be marked as such for the device.

3. AC-Input

The device is suitable to be supplied from TN, TT or IT mains networks. For more details, please review chapter 2.

AC input voltage rated range	Nom.	3AC 380-480V	
AC input operating range		3x 323-552Vac	
Input frequency	Nom.	50–60Hz	±6%
Turn-on voltage	Typ.	3x 320Vac	Steady-state value, see Fig. 3-1
Shut-down voltage	Typ.	3x 300Vac	Steady-state value, see Fig. 3-1
Loss of one phase		will continue to operate without interruption if loaded below limits in figure see Fig. 23-1	
External input protection		See recommendations in chapter 2.	

		3AC 400V	3AC 480V	
Input current	typ.	0.5A	0.42A	At 300W, symmetrical phase voltages, see Fig. 3-3 Power
Power factor	typ.	0.90	0.90	At 300W, see Fig. 3-4
Start-up delay	typ.	1s	1s	At 300W symmetrical phase voltages, see Fig. 3-2
Rise time	typ.	10ms	10ms	At 300W constant current load, 0mF load, see Fig. 3-2
	typ.	12ms	12ms	At 300W constant current load, 12.5mF, see Fig. 3-2
Turn-on overshoot	Max.	500mV	500mV	See Fig. 3-2

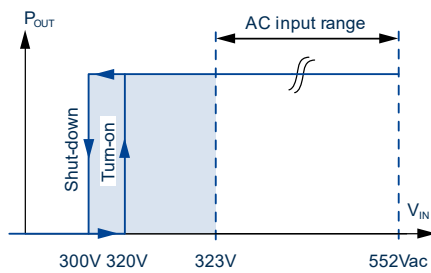

Fig. 3-1: Input voltage range

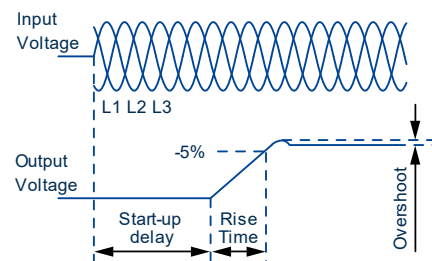

Fig. 3-2: Turn-on behavior, definitions

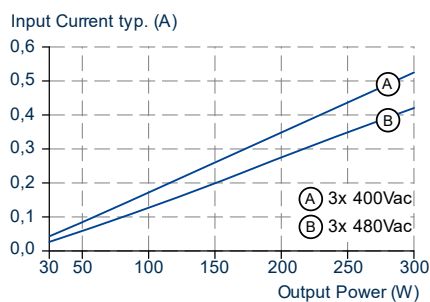

Fig. 3-3: Input current vs. output Power at 24V output voltage

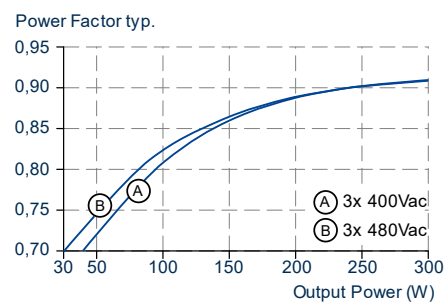

Fig. 3-4: Power factor vs. output power at 24V output voltage

4. DC-Input

Do not operate this power supply with DC-input voltage.

5. Input Inrush Current

The power supply is equipped with an active inrush current limitation circuit, which limits the input inrush current after turn-on to an extremely low value. The inrush current is usually smaller than the steady state input current.

		3AC 400V	3AC 480V	
Inrush current *)	max.	2A _{peak}	2A _{peak}	Temperature independent
	typ.	1.5A _{peak}	1.5A _{peak}	Temperature independent
Inrush energy	max.	0.1A ² s	0.1A ² s	Temperature independent

*) The charging current into EMI suppression capacitors is disregarded in the first microseconds after switch-on.

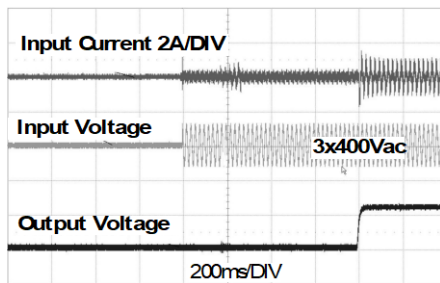

Fig. 5-1: Typical turn-on behavior at nominal load and 25°C ambient temperature

6. Output

The output provide a (PELV/ES1) rated voltage, which is galvanically isolated from the input voltage. The negative potential of the output is permanently connected to PE within the unit.

The device is designed to supply any kind of loads, including capacitive and inductive loads. If capacitors with a capacitance >100mF are connected to the output, this the unit might charge the capacitor in hiccup mode.

The output is electronically protected against overload, no-load and short-circuits. In case of a protection event, audible noise may occur.

The device is featured with a “soft output regulation characteristic” in order to achieve current share between multiple devices when they are connected in parallel. The “soft output regulation characteristic” regulates the output voltage in such a manner that the voltage at no load is approx. 4% higher than at nominal load.

Output voltage	nom.	24V	23.8 - 25.2V	
Adjustment range			Not adjustable	
Factory setting	typ.	24.5V	±0.2%, at 12.5A (results to 25V±0.2% at no load) Above 12.5A the output voltage stays stable at 24V	
Line regulation	max.	10mV	Between 3x323 and 576Vac input voltage change	
Load regulation	typ.	1000mV	Between 0 and 12.5A output load, static value	
	typ.	50mV	Between 12.5 and 25A output load, static value	
Ripple and noise voltage	max.	100mVpp	Bandwidth 20Hz to 20MHz, 50Ohm	
Total output power	nom.	300W ¹⁾	Up to +55°C at ambient temperatures, see Fig. 6-1	
	nom.	150W	At +70°C at ambient temperatures	
	short term up to 1s	nom.	450W	Up to +55°C at ambient temperatures, see Fig. 6-1
	short term up to 60s	nom.	600W	Up to +70°C at ambient temperatures
			Derate linearly between +55°C and +70°	
Overload/ short-circuit current	max.	15A	Continuous current, see Fig. 6 1	
	typ.	27A / 22A	At heavy overloads (when output voltage falls below 13V), the power supply delivers continuous output current for 2s. After this, the output is switched off for approx. 18s before a new start attempt is automatically performed. This cycle is repeated as long as the overload exists. If the overload has been cleared, the device will operate normally, see Fig. 6-2. Load impedance 10mOhm. Discharge current of output capacitors is not included.	
	max.	7.8A	Intermitted current average value (R.M.S.) Load impedance 10mOhm, see Fig. 6 3	
Output capacitance	typ.	18 000µF	Included inside the power supply	
Parallel Use			Do not parallel units for higher output currents	
Back-feeding loads	max.	35V / 4.3J	The unit is resistant and does not show malfunctioning when a load feeds back voltage to the power supply. It does not matter whether the power supply is on or off. The absorbing energy can be calculated according to the built-in large sized output capacitor.	
		32V / 2.8J		

1) Power Boost This power/ current is continuously allowed up to an ambient temperature of 45°C. Above 45°C, do not use this power or current longer than a duty cycle of 10% and/ or not longer than 1 minute every 10 minutes.

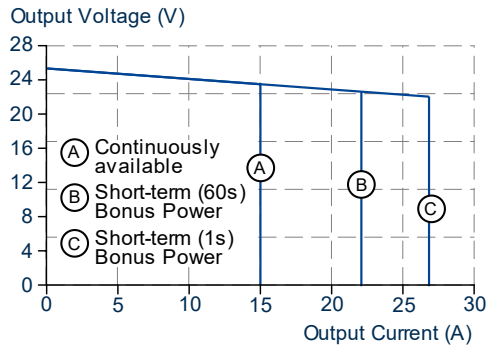

Fig. 6-1: Output voltage vs. output current, for continuous load, typ.

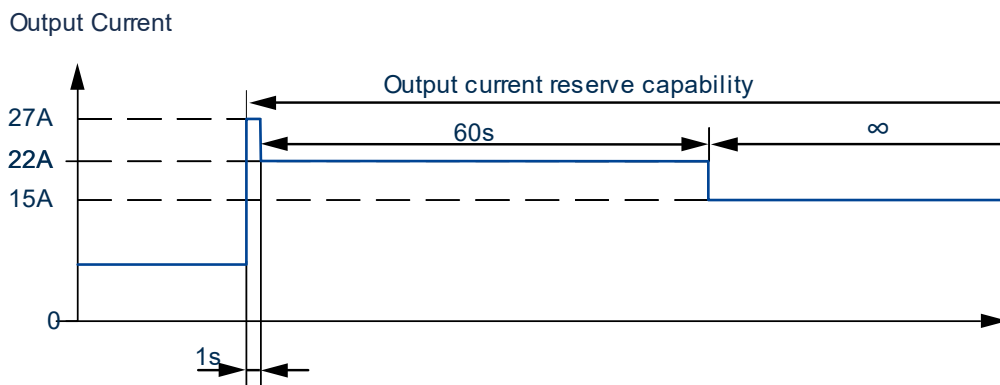

Fig. 6-2: Short term output current capability, typ.

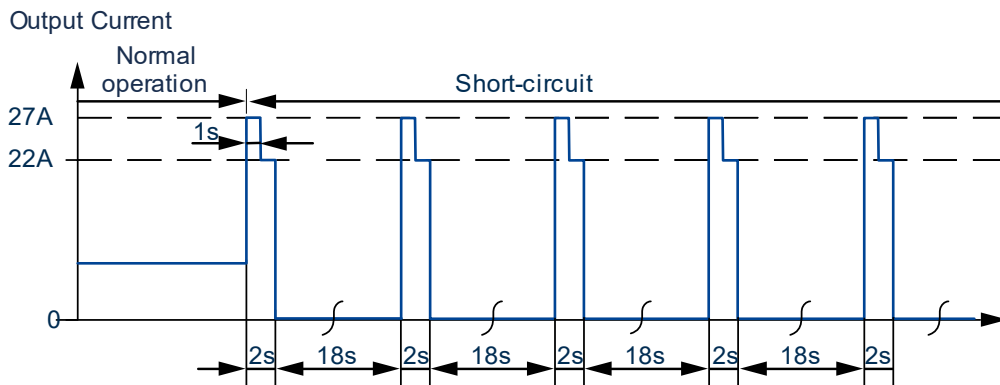

Fig. 6-3: Short-circuit on output, HiccupPLUS mode, typ.

7. Hold-up Time

The hold-up time is the time during which a power supply's output voltage remains within specification following the loss of input power. The hold-up time is output load dependent. At no load, the hold-up time can be up to several seconds. The green DC-OK LED is also on during this time.

		3AC 400V	3AC 480V	
Hold-up Time	typ.	50ms	50ms	At 150W output load, see Fig. 7-1
	min.	40ms	40ms	At 150W output load, see Fig. 7-1
	typ.	25ms	25ms	At 300W output load, see Fig. 7-1
	min.	20ms	20ms	At 300W output load, see Fig. 7-1

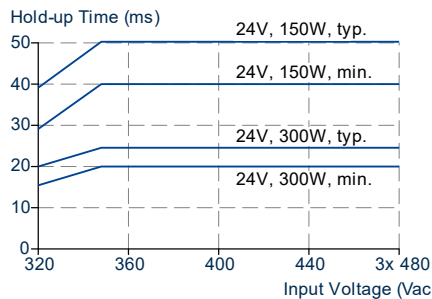

Fig. 7-1: Hold-up time vs. input voltage

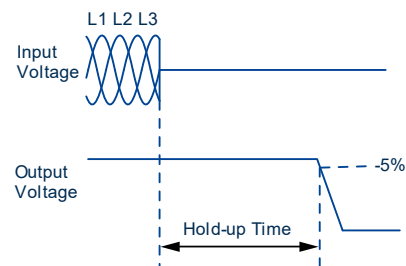

Fig. 7-2: Shut-down behavior, definitions

8. DC-OK Relay Contact

This feature monitors the output voltage, which is produced by the power supply itself. It is independent of an eventually present external voltage on the output of the power supply.

Contact closes	As soon as the output voltage reaches typ. 22Vdc. The DC-OK Relay Contact is synchronized with the Status Led.
Contact opens	As soon as the output voltage dips below 22Vdc. Short dips will be extended to a signal length of 100ms. Dips shorter than 1ms will be ignored.
Switching hysteresis	1V
Contact ratings	Maximal 60Vdc 0.3A, 30Vdc 1A, 30Vac 0.5A, resistive load Minimal permissible load: 1mA at 5Vdc
Isolation voltage	See dielectric strength table in chapter 18

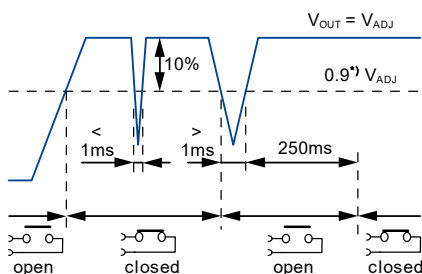

Fig. 8-1: DC-OK relay contact behavior

9. Efficiency And Power Losses

		3AC 400V	3AC 480V	
Efficiency	typ.	95.2%	95.0%	At 24V, 300W
Average efficiency	typ.	93.6%	93.1%	25% at 75W, 25% at 150W, 25% at 225W, 25% at 300W
Power losses	typ.	3.0W	3.0W	At 24V, 0W (no load)
	typ.	10.0W	10.5W	At 24V, 150W (half load)
	typ.	15.1W	15.8W	At 24V, 300W (full load)

*) The average efficiency is an assumption for a typical application where the power supply is loaded with 25% of the nominal load for 25% of the time, 50% of the nominal load for another 25% of the time, 75% of the nominal load for another 25% of the time and with 100% of the nominal load for the rest of the time.

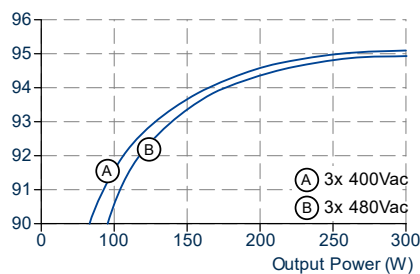

Fig. 9-1: Efficiency vs. output power at 24V, typ.



Fig. 9-2: Losses vs. output power at 24V, typ.

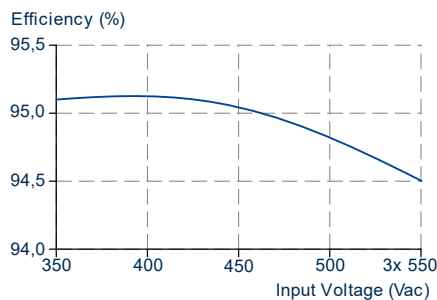

Fig. 9-3: Efficiency vs. input voltage at 24V, 300W, typ.

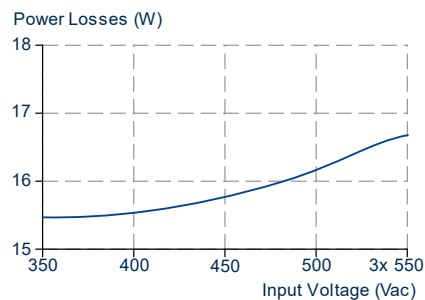

Fig. 9-4: Losses vs. input voltage at 24V, 300W, typ.

10. Lifetime Expectancy

The Lifetime expectancy shown in the table indicates the minimum operating hours (service life) and is determined by the lifetime expectancy of the built-in electrolytic capacitors. Lifetime expectancy is specified in operational hours and is calculated according to the capacitor's manufacturer specification.

The manufacturer of the electrolytic capacitors only guarantees a maximum life of up to 15 years (131 400h). Any number exceeding this value is a calculated theoretical lifetime which can be used to compare devices.

	3AC 400V	3AC 480V	
Calculated lifetime expectancy	235 000h	195 000h	At 24V, 300W and 40°C
	312 000h	293 000h	At 24V, 150W and 40°C
	664 000h	551 000h	At 24V, 300W and 25°C
	882 000h	829 000h	At 24V, 150W and 25°C

11. MTBF

MTBF stands for **Mean Time Between Failure**, which is calculated according to statistical device failures, and indicates reliability of a device. It is the statistical representation of the likelihood of a unit to fail and does not necessarily represent the life of a product.

The MTBF figure is a statistical representation of the likelihood of a device to fail. A MTBF figure of e.g. 1 000 000h means that statistically one unit will fail every 100 hours if 10 000 units are installed in the field. However, it can not be determined if the failed unit has been running for 50 000h or only for 100h.

For these types of units the MTTF (**Mean Time To Failure**) value is the same value as the MTBF value.

	3AC 400V	3AC 480V	
MTBF SN 29500, IEC 61709	838 000h	814 000h	At 24V, 300W and 40°C
	1 421 000h	1 380 000h	At 24V, 300W and 25°C
MTBF MIL HDBK 217F	281 000h	268 000h	At 24V, 300W and 40°C; Ground Benign GB40
	383 000h	366 000h	At 24V, 300W and 25°C; Ground Benign GB25
	65 000h	62 000h	At 24V, 300W and 40°C; Ground Fixed GF40
	88 000h	84 000h	At 24V, 300W and 25°C; Ground Fixed GF25

12. Functional Diagram

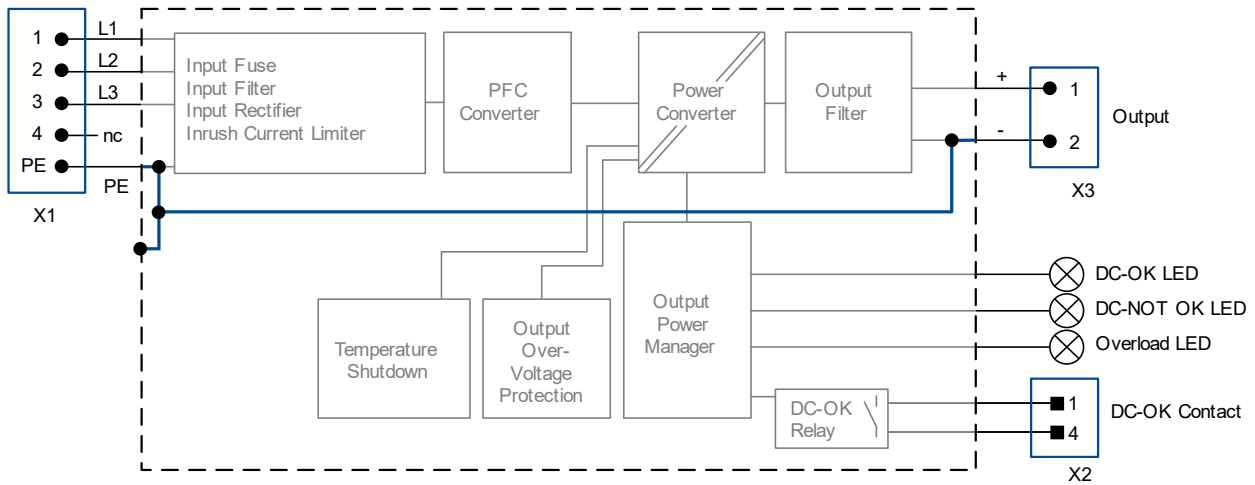
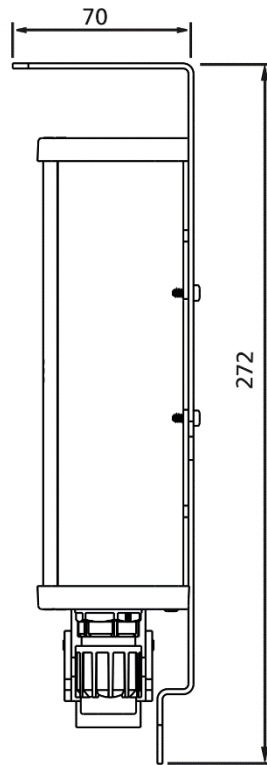
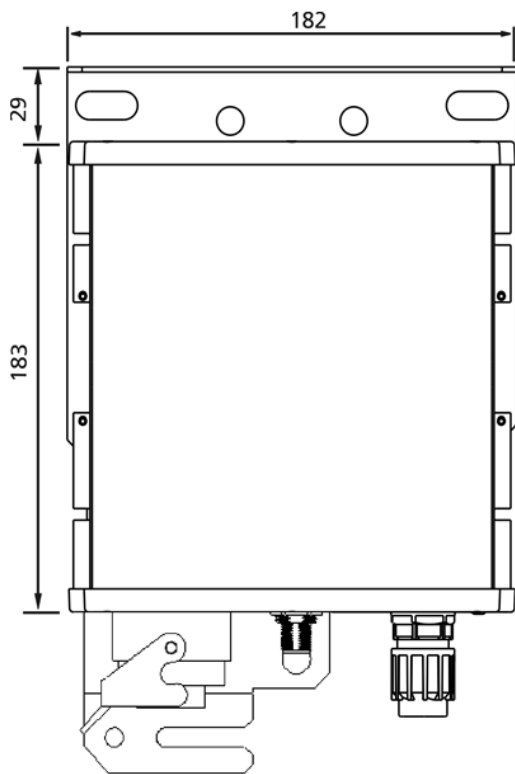

Fig. 12-1: Functional Diagram FPT300.242-008-102

13. Dimensions And Connector Variants

FPT300.242-008-102



Width	182mm / 7.17"
Height	272mm / 10.7"
Depth	70mm / 2.76"
Weight	1550g / 3.4lb
Housing material	
Body:	Aluminium alloy
Covers:	Hi-grade polycarbonate
Installation clearances	See chapter 2

Input Connection (X1):



Harting HanQ4/2	Q4/2 Set AS female 2.5-6mm ² 7-13mm	Harting order code 6104401263700	PULS order code ZCF.hanq42
	Q4/2 Set AS female 2.5-6mm ² 14-17mm	Harting order code 6104401263800	PULS order code ZCF.hanq42-1
Pin assignment	Pin 1	L1	
	Pin 2	L2	
	Pin 3	L3	
	Pin with the PE symbol	PE connection	

IO-Link Connection (X2):

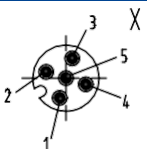

M12 A coded	M12-A 5pin cut clamp female 0.34-0.5mm ² / 6-8mm	Harting order code 21032722505	PULS order code ZCF.m12a5p
Pin assignment	Pin 1 and Pin 4 for relay contact		

Output Connection (X3):

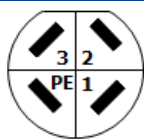

QuickON			
Pin assignment	Pin 1	(+) pole	
	Pin 2	(-) pole	

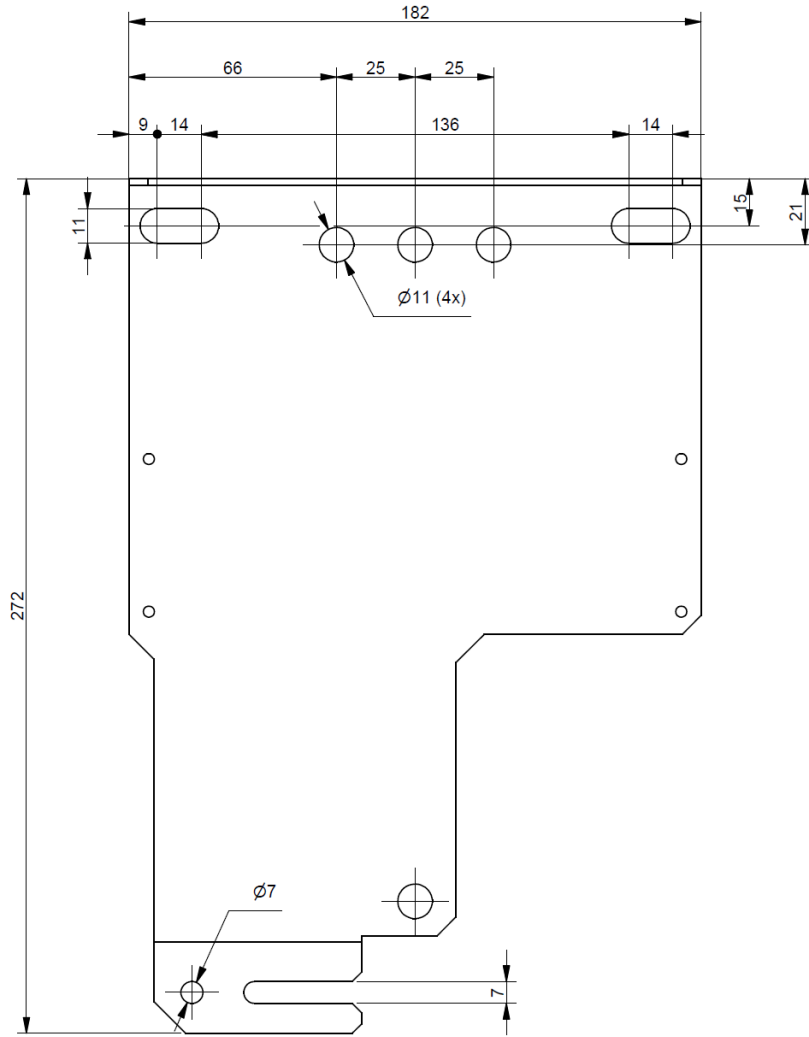

Fig. 13-1: Hole pattern for wall mount

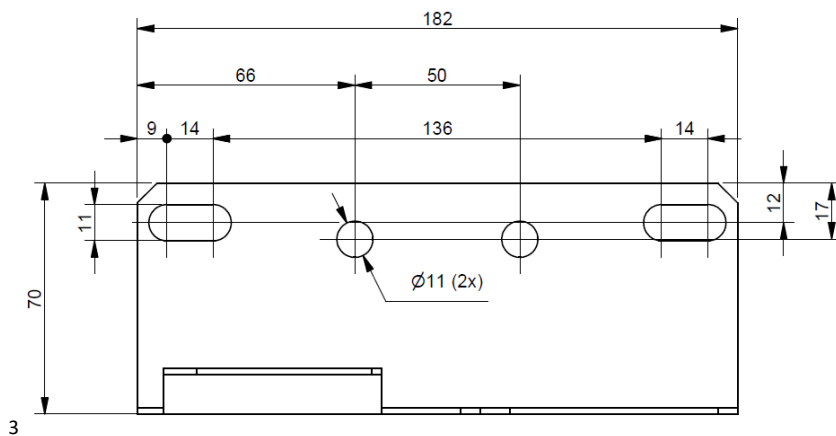
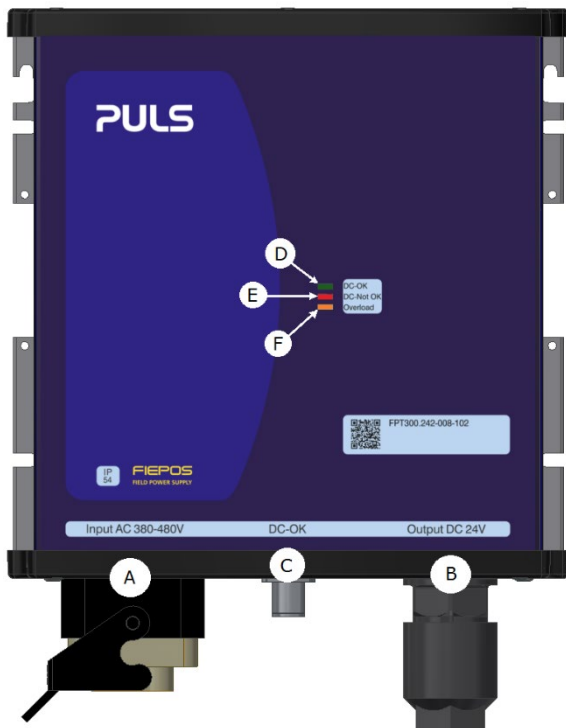
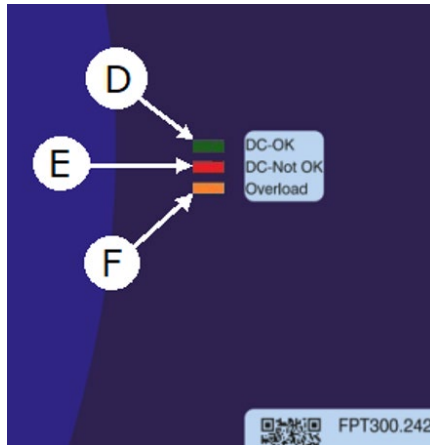

Fig. 13-2: Hole pattern for front mount

14. User Interface



- A. Input Connector
- B. Output Connector
- C. DC-OK Signal Connector
- D. DC-OK LED
- E. DC-NOT-OK LED
- F. Overload LED



LED Signalization Overview

The three LEDs on the front side is used to signalize conditions of the Power Supply.

- **DC-OK LED lights up green continuously if the**
DC voltage is above 22V and all outputs run according to their settings.
- **DC-NOT-OK LED lights up red continuously if the**
DC voltage output voltage is below 22V of a running device.
- **Overload LED lights up red continuously if the**
output current is higher than 15A.
- **LEDs are off continuously if the**
power supply is not powered.

15. EMC

The EMC behavior of the device is designed for applications in industrial environment as well as in residential, commercial and light industry environments.

The device is investigated according to EN 61000-6-1, EN 61000-6-2, EN 61000-6-3, EN 61000-6-4, EN 61000-3-2 and EN 61000-3-3.

EMC immunity

Electrostatic discharge	EN 61000-4-2	Contact discharge	8kV	Criterion A
Air discharge		Air discharge	15kV	Criterion A
Electromagnetic RF field	EN 61000-4-3	80MHz - 2.7GHz	10V/m	Criterion A
		2.7GHz - 6GHz	3V/m	Criterion A
Magnetic field	EN 61000-4-8	50Hz/60Hz	30A/m	Criterion A
Fast transients (Burst)	EN 61000-4-4	AC Input lines	4kV	Criterion A
		DC Output lines	2kV	Criterion A
		DC OK Output	2kV	Criterion A
Surge voltage on AC input	EN 61000-4-5	Lx to Ly	2kV	Criterion A
		L to -PE	4kV	Criterion A
Surge voltage on DC output	EN 61000-4-5	+ to -	1kV	Criterion A
		+/- to PE	1kV	Criterion A
		DC-OK to PE	1kV	Criterion A
Conducted immunity	EN 61000-4-6	0.15 - 80MHz	20V	Criterion A
Voltage dips	EN 61000-4-11	0V	1 cycle	Criterion A
		40% of V_{nom}	200ms	Criterion A
		70% of V_{nom}	500ms	Criterion A
Voltage interruptions	EN 61000-4-11	0V	5000ms	Criterion C
Powerful transients	VDE 0160	Over entire load range	1550V, 1.3ms	Criterion A

Performance criterions:

A: The device shows normal operation behavior within the defined limits.

C: Temporary loss of function is possible. The device may shut-down and restarts by itself. No damage or hazards for the device will occur.

EMC Emission

Conducted emission AC input lines	EN 55032 , FCC Part 15	Class B
Conducted emission DC output lines		
Conducted emission DC OK Output		
Radiated emission	EN 55032 / EN 55011	Class B
Harmonics	EN 61000-3-2	Pass for Class A equipment
Voltage fluctuations, flicker	EN 61000-3-3	Pass tested with constant current loads, non pulsing

This device complies with FCC Part 15 rules.

Operation is subjected to following two conditions: (1) this device may not cause harmful interference, and (2) this device must accept any interference received, including interference that may cause undesired operation..

Switching Frequencies

PFC converter	20kHz to 135kHz	Input voltage and output load dependent
Main converter	60kHz to 140kHz	Output load dependent
Auxiliary converter	54kHz to 66kHz	Output load dependent
Microcontroller clocks	48Mhz and 32MHz	Fixed frequency

16. Environment

Operational temperature	-25°C to +70°C (-13°F to 158°F)	Operational temperature is the same as the ambient or surrounding temperature and is defined as the air temperature 2cm below the unit.
Storage temperature	-40°C to +85°C (-40°F to 185°F)	For storage and transportation
Output de-rating	10W/°C 20W/1000m or 5°C/1000m The de-rating is not hardware controlled. The user has to take this into consideration to stay below the de-rated current limits in order not to overload the unit.	Between +55°C and +70°C (131°F to 140°F) For altitudes >2000m (6560ft), see Fig. 16-2: Output power vs. altitude
Humidity	5 to 95% r.h.	According to IEC 60068-2-30
Atmospheric pressure	54-110kPa	see Fig. 16-2: Output power vs. altitude for details
Altitude	Up to 5000m (16 400ft)	see Fig. 16-2: Output power vs. altitude for details
Over-voltage category	III II	According to IEC 60664-1 For TN, TT mains systems with earthed neutral and IT star mains systems with insulation monitoring for altitudes up to 2000m According to IEC 60664-1 For TN, TT mains systems with earthed neutral and IT star mains systems with insulation monitoring for altitudes between 2000m and 5000m According to IEC 60664-1 For TN, TT, IT Delta mains systems or IT star mains systems without insulation monitoring for altitudes up to 2000m
Degree of pollution	3	According to IEC 62477-1, not conductive
Vibration sinusoidal	2-17.8Hz: ±1.6mm; 17.8-500Hz: 2g 2 hours / axis	According to IEC 60068-2-6
Shock	30g 6ms, 20g 11ms 3 bumps / direction, 18 bumps in total Shock and vibration is tested in combination with DIN-Rails according to EN 60715 with a height of 15mm and a thickness of 1.3mm and standard orientation.	According to IEC 60068-2-27
LABS compatibility	Yes	
Audible noise	Some audible noise may be emitted from the power supply during no load, overload or short circuit.	

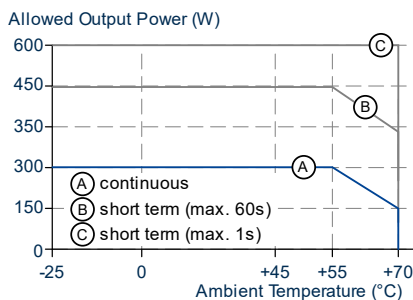

Fig. 16-1: Output power vs. ambient temp.

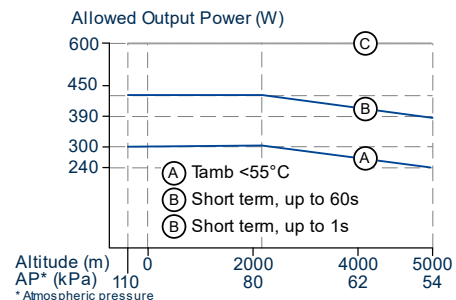

Fig. 16-2: Output power vs. altitude

17. Safety And Protection Features

Isolation resistance	min.	500MΩ	At delivered condition between input and output, measured with 500Vdc
	min.	500MΩ	At delivered condition between input and PE, measured with 500Vdc
	min.	500MΩ	At delivered condition between output and Output OK contacts, measured with 500Vdc
PE resistance	max.	0.1Ω	Resistance between PE terminal and the housing
Input/Output separation		PELV	IEC/EN/UL 61010-2-201, IEC/EN 62368-1, IEC/EN 60950-1
Output over-voltage protection	typ.	31.8Vdc	In case of an internal defect, a redundant circuit limits the maximum output voltage. The output shuts down and automatically attempts to restart
	max.	32.5Vdc	
Class of protection			According to IEC 61140 A PE (Protective Earth) connection is required
Ingress protection		IP 54	According to EN/IEC 60529
Over-temperature protection		Included	Output shut-down with automatic restart. Temperature sensors are installed on critical components inside the unit and turn the unit off in safety critical situations, which can happen e.g. when ambient temperature is too high, ventilation is obstructed or the de-rating requirements are not followed. There is no correlation between the operating temperature and turn-off temperature since this is dependent on input voltage, load and installation methods.
Input transient protection		MOV (Metal Oxide Varistor)	For protection values, see chapter 22.2, EMC.
Internal input fuse		Included	Not user replaceable slow-blow high-braking capacity fuse
Touch current (leakage current)	max.	0.45 / 1.5 mA	At 3x 480Vac, 60Hz, TN-,TT-mains / IT-mains Lower currents at lower voltages and frequencies.

18. Dielectric Strength

The negative potential of the outputs is permanently connected to PE within the unit. The output is insulated from the input by a double or reinforced insulation.

Type and routine tests are conducted by the manufacturer. Field tests may be conducted in the field using the appropriate test equipment which applies the voltage with a slow ramp (2s up and 2s down). Connect all input-terminals before conducting the test. When testing, set the cut-off current settings to the value in the table below.

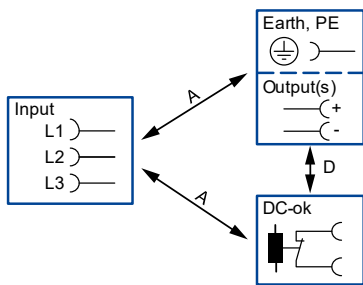





Fig. 18-1: Dielectric strength

		A	D
Type test	60s	2700Vac	500Vac
Routine test	5s	2200Vac	500Vac
Field test	5s	2000Vac	500Vac
Cut-off current setting for field test		> 10mA	> 10mA

19. Approvals And Fulfilled Standards

IEC 62368-1	IECEE CB SCHEME	CB Scheme Certificate IEC 62368-1 - Audio/video, information and communication technology equipment - Safety requirements Output safety level: ES1
IEC 61010	IECEE CB SCHEME	CB Scheme Certificate IEC 61010-2-201 - Electrical Equipment for Measurement, Control and Laboratory Use - Particular requirements for control equipment
IEC 60950-1		Manufacturers Declaration IEC 60950-1 - General safety requirements for Information Technology Equipment (ITE)
UL 61010		UL Certificate Listed equipment for category NMTR - UL 61010-2-201 - Electrical equipment for measurement, control and laboratory use - Particular requirements for control equipment Applicable for US and Canada E-File: E198865
Semi F47	SEMI F47	Test Report Voltage Sag Immunity for Semiconductor Processing Equipment Tested for AC 400V L-L mains voltages, nominal output voltage and nominal output load
VDMA 24364	LABS VDMA 24364-C1-L/W	Paint Wetting Impairment Substances Test (or LABS-Test) Tested for Zone 2 and test class C1 according to VDMA 24364-C1-L/W for solvents and water-based paints

20. Regulatory Compliance

EU Declaration of Conformity		Trade conformity assessment for Europe The CE mark indicates conformance with the European - EMC directive - Low-voltage directive (LVD) - RoHS directive
WEEE Directive		Manufacturer's Statement EU-Regulation on Waste Electrical and Electronic Equipment Registered in Germany as business to business (B2B) products.
REACH Directive	REACH ✓	Manufacturer's Statement EU-Regulation regarding the Registration, Evaluation, Authorisation and Restriction of Chemicals
RoHS-China		Manufacturer's Statement Administrative Measures for the Restriction of the Use of Hazardous Substances in Electrical and Electronic Products 25 years
IEC/EN 61558-2-16 (Annex BB)	Safety Isolating Transformer	Safety Isolating Transformers corresponding to Part 2-6 of the IEC/EN 61558

21. Accessories

21.1. DIN RAIL Mounting KIT: ZM.FP-DIN2

In addition to screw mounting FIEPOS has the option to be simply attached to a DIN rail.

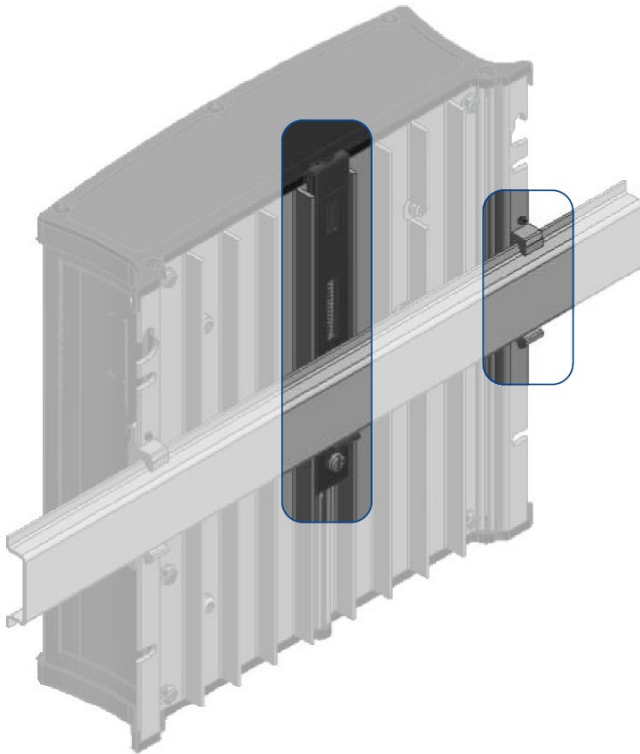

- DIN-Rail not included
- DIN-Fixture pre-assembled

21.2. Connectors

FIEPOS features a large number of different connectors. Mating connectors can be ordered at PULS from stock in order to be able to supply customers quickly in the design-in phase.

For a higher number of pieces or other options use www.harting.com.

Connector Name	Order number	Connector Description
Harting HanQ4/2	ZCF.hanq42	Q4/2 Set AS female 2.5-6mm ² 7-13mm
Harting HanQ4/2	ZCF.hanq42-1	Q4/2 Set AS female 2.5-6mm ² 14-17mm
Harting HanQ2/0	ZCM.hanq20	Q2/0 Set screw male 2.5-6mm ² 6-12mm
Harting HanQ4/0	ZCM.hanq40	Q4/0 Set 1m cable 2,5mm ² IP67
Harting HanQ5/0	ZCF.hanq50	Q5/0 Set QuickLock female 0.5-2.5mm ² 6-12mm
Harting M12-A	ZCF.m12a5p	M12-A 5pin cut clamp female 0.34-0.5mm ² / 6-8mm
Harting M12-A	ZCM.m12a5p	M12-A 5pin cut clamp male 0.34-0.5mm ² / 6-8mm
Harting M12-S	ZCF.m12s4p	M12-S 4pin screw female 2.5mm ² / 6-8mm
Harting M12-L	ZCM.m12l5p	M12-L 5pin cut clamp male 0.75-1.5mm ² / 5.8-13.5mm
Harting M12-T	ZCM.m12t4p	M12-T 4pin screw male 1.5mm ² / 8-10mm
Harting 7/8"	ZCM.78inch4p	7/8" 4pin screw male 1.5mm ² / 6-8mm
Harting 7/8"	ZCF.78inch3p	7/8" 3pin screw female 1.5mm ² / 6-8mm
Harting 7/8"	ZCF.78inch5p	7/8" 5pin screw female 0.75-1.5mm ² / 6.8-12.5mm

All parameters are specified at 24V, 12.5A, 230Vac, 25°C ambient and after a 5 minutes run-in time unless otherwise noted.

22. Related Products

The FIEPOS product family includes various devices with different technical parameters and features. The following page provides a general overview of the available solutions. Please also get in touch with your PULS contact person, for more detailed application advice and technical information.

FPT300.242-008-103:

Power Supply similar to [FPT300.242-008-102](#) but with protection grade [IP65/67](#) and without mounting braked.



SHORT-FORM DATA

Output voltage	DC 24V	Nominal
Adjustment range		Not adjustable
Output power	Continuous:	
	300W	Up to +55°C ambient
	150W	At +70°C ambient
	Short-term, up to:	
	450W / 60s	Up to +55°C ambient
	600W / 1s	At +70°C ambient
	Derate linearly between +55°C to +70°C	
Protection Grade	IP65/67	

FPT300.241-002-101:

Power Supply with [HAN connectors](#) on in- and output and protection grade [IP65/67](#).



SHORT-FORM DATA

Output voltage	DC 24V	Nominal
Adjustment range		Not adjustable
Output power	Continuous:	
	300W	Up to +55°C ambient
	150W	At +70°C ambient
	Short-term, up to:	
	450W / 60s	Up to +55°C ambient
	600W / 1s	At +70°C ambient
	Derate linearly between +55°C to +70°C	
	HANQ4/2 input and HANQ4/0 output connectors	

23. Application Notes

23.1. Repetitive Pulse Loading

Typically, a load current is not constant and varies over time. This power supply is designed to support loads with a higher short-term power demand (=BonusPower®). The short-term duration is hardware controlled by an output power manager and is available on a repeated basis. If the average load is higher than the nominal output power, the output voltage will dip.

To avoid this, the following rules must be met:

- a) The power demand of the pulse must be below 200% of the nominal output power.
- b) The duration of the pulse power must be shorter than the allowed BonusPower® time. (see output section)
- c) The average power should be lower than the nominal output power.

The R.M.S. output current must be below the specified continuous output current. If the R.M.S. current is higher, the unit will respond with a thermal shut-down after a period of time.

23.2. External Input Protection

The device is designed, tested and approved for branch circuits up to 30A (UL) and 32A (IEC) without additional protection device. If an external fuse is utilized, do not use circuit breakers smaller than 30A B- or C-Characteristic to avoid a nuisance tripping of the circuit breaker.

23.3. Inductive and Capacitive Loads

The unit is designed to supply any kind of loads, including capacitive and inductive loads. If extreme large capacitors, such as EDLCs (electric double layer capacitors or "UltraCaps") with a capacitance larger than 100mF are connected to the output, the unit might charge the capacitor in the HiccupPLUS mode (see chapter).

23.4. Two Phases Operation

No external protection devices are required to protect against a phase-loss.

Continuous two phase operation is not recommended for this power class since the supplying 3-phase network could become unbalanced. However, if one phase fails, the unit may continue to operate if the load is below the power limit shown in Fig. 24-1.

Exceeding of these limits for an extended period may result in a thermal shut-down of the unit.

During power-on, some start-up attempts can occur until a permanent output power is available. EMC performance, hold-up time, losses, and output ripple differ from a three phase operation. Such use is not included in the approval according to UL61010 and IEC62368.

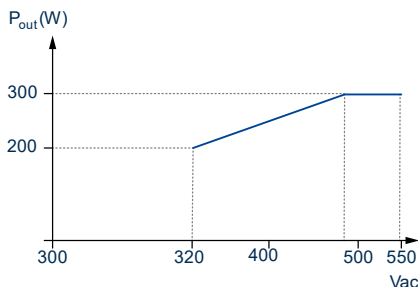
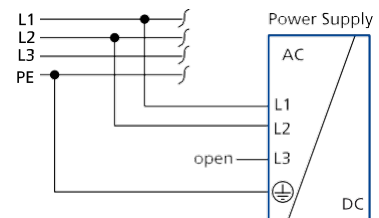

Fig. 23-1: Two phase power capability

23.5. Back Feeding Loads

Loads such as decelerating motors and inductors can feed voltage back to the power supply. This feature is also called return voltage immunity or resistance against Back- E.M.F. (Electro Magnetic Force).

This power supply is resistant and does not show malfunctioning when a load feeds back voltage to the power supply. It does not matter whether the power supply is on or off.

23.6. Mounting Orientations

The device can be mounted in various mounting orientations. The listed lifetime and MTBF values from this datasheet apply only for the standard mounting orientation. The following curves give an indication for allowed output power in different mounting orientations for altitudes up to 2000m (6560ft).

