

User Manual PISA-M



This user manual applies to the following product variants:

- PISA-M-4ADJ
- PISA-M-402
- PISA-M-404
- PISA-M-406
- PISA-M-408

1	Intended Use.....	2
2	Factory Settings.....	2
3	Front Side and User Elements.....	3
4	Output Channel Status LEDs.....	4
5	Turn Output Channels ON or OFF.....	5
6	Check Current Tripping Setpoint of Each Output Channel.....	5
7	Set Current Tripping Setpoint of Each Output Channel.....	6
8	Set Tripping Characteristic of the Output Channels.....	7
9	Change Power Supply Overload Protection.....	8
10	Set Button Reaction Style.....	9
11	Reset Tripped Output Channels.....	10
	11.1 Remotely Reset via Control Input.....	10
	11.2 Manually Reset at Front Side User Elements.....	10
12	Select Communication Mode.....	11

1. Intended Use

This user manual offers instructions on how to use the local user interface to configure the PISA-M electronic circuit breaker.

Configurable product properties

- Current tripping setpoint independent for each output channel
(Adjustable only on the PISA-M-4ADJ model. All PISA-M-40x versions have fixed current tripping setpoints)
- Fast / slow tripping characteristic
- Button reaction style
- Signaling and communication features
- Power supply protection

i The LEDs next to the Channel Control Buttons show the status of each output channel.

Symbols explained

i	NOTE: Additional information
⇒	Action step
✓	Positive result
CCB	Channel Control Button

2. Factory Settings

- All output channels: ON
- Tripping characteristic: Fast
- Button reaction style: Standard
- Status Signal Output: Switch closes
- Tripping setpoints of the output channels according to ordered product version

3. Front Side and User Elements

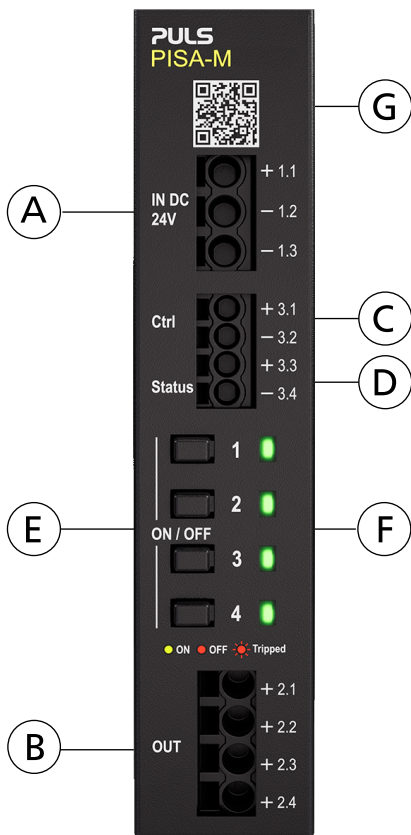

A Input Terminals

Identical poles are internally connected.

- 1.1 (+) Input 12 - 24V / 20A
- 1.2 (-) Input
- 1.3 (-) Input

B Output Terminals

- 2.1 (+) Output Channel 1
- 2.2 (+) Output Channel 2
- 2.3 (+) Output Channel 3
- 2.4 (+) Output Channel 4

C Control Signal Input

- 3.1 (+) Signal input positive pole
- 3.2 (-) Signal input negative (return) pole

Signal output can be set to several operation modes.

D Status Signal Output

- 3.3 (+) Signal output positive pole
- 3.4 (-) Signal output negative (return) pole

Signal input can be used to send reset signal (1 s active) or for data communication using Digital Coded Interface.

E / F Channel Control Buttons (CCB) and Status LEDs







- 1 CCB1 and LED 1
- 2 CCB2 and LED 2
- 3 CCB3 and LED 3
- 4 CCB4 and LED 4

G QR code for direct access to documentation.

4. Output Channel Status LEDs



The device front shows four LEDs – one per output channel. The LEDs indicate the status of each output channel.

-  **Green:**
Output channel ON
-  **Yellow:**
Output channel overload – prewarning before channel is triggered
-  **Red:**
Output channel turned OFF (manually or remotely)
-  **Red (flashing):**
Output channel tripped due to overload of this channel
-  **Red (double-flashing):**
Output channel tripped due to
 - a) device overload protection
total output current > 20 A for > 2 s
 - b) power supply protection mode activated
-  **Yellow (flashing):**
For details see following configuration settings
-  **LED OFF:**
Device not powered

5. Turn Output Channels ON or OFF

Each output channel can be switched ON and OFF individually.

The required duration of button press can be configured, see chapter 10 "Button Reaction Style".

- Output channel is ON → LED lights up green
- Output channel is OFF → LED lights up red

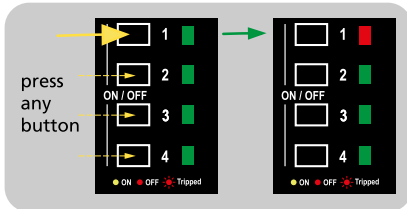

⇒ Press the Channel Control Button (CCB) for the output channel to be modified depending on the selected button reaction style:

- ⇒ 50 ms in standard mode or
- ⇒ 1 s in long press mode

✓ The output channel will switch between ON and OFF.

6. Check Current Tripping Setpoint of Each Output Channel

Each LED indicates the current tripping setpoint for each output channel.

For example: LED 1 shows setting of output channel 1.

1. The number of flashes indicates current setting in ampere.
For example: LED 1 flashes 4 x, set current tripping setpoint for output channel 1 is 4 A.
2. The sequence will be shown two times.
3. The device exits the checking mode and will return to regular operation.

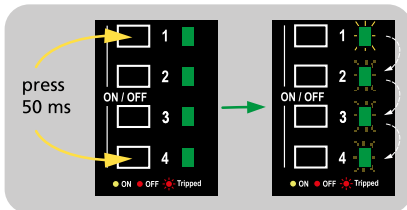

⇒ Press **CCB1** and **CCB4** simultaneously for **50 ms**.

✓ Each LED will indicate the current tripping setpoint for each output channel by flashing green.

i Pressing any button during LED flashing stops the checking mode immediately.

7. Set Current Tripping Setpoint of Each Output Channel

- i** Only adjustable on PISA-M-4ADJ
- All other PISA-M-40x versions come with four fixed output channels which cannot be adjusted.
- The device will exit setting mode automatically after **10 s** inactivity.

The PISA-M-4ADJ allows individual adjustment of the tripping current of each output channel. Each output channel can be set independently to 1, 2, 3, 4, 6 or 8 A.

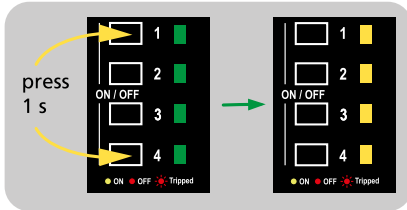

- ⇒ Press **CCB1** and **CCB4** simultaneously for **1 s**.
- ✓ All LEDs will turn yellow to indicate the present setting mode.

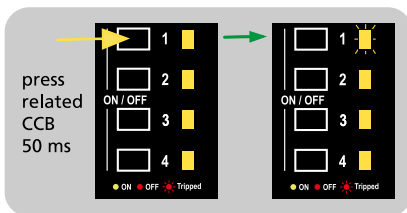

- ⇒ Select the output channel to be set by pressing the related CCB for **50 ms within 10 s**.
- ✓ The associated LED starts flashing yellow.
- i** The number of flashes show the set value in ampere, e.g. 4 x flashing = 4 A.

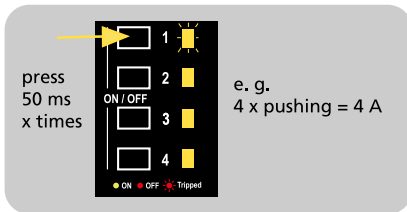

- ⇒ To change the current limit press the **related CCB** x times for **50 ms within 4 s**.
- i** Number of pushes equals set current in ampere.
- ✓ The associated LED flashes yellow according to the presently selected current in ampere.
- i** The new set value is not stored automatically.

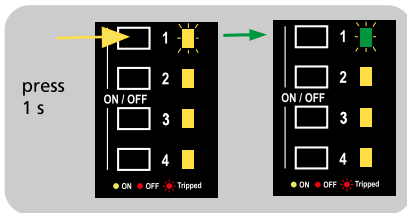

- ⇒ To store the new set current for the selected output channel press the **related CCB** for **1 s**.
- ✓ The associated LED flashes green according to the now stored current setting in ampere.
- i** Repeat these steps until all output channels have been set to required values.

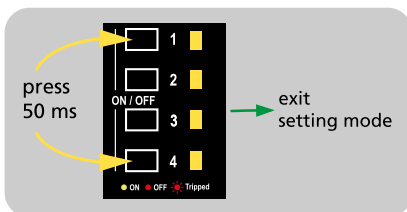

- ⇒ To exit setting mode press **CCB1** and **CCB4** simultaneously for **50 ms**.

8. Set Tripping Characteristic of the Output Channels



- The tripping characteristics can be uniformly configured as slow or fast for all output channels on all PISA-M versions.
- The device will exit setting mode automatically after **4 s** inactivity.

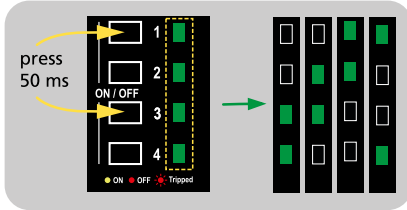

⇒ Press **CCB1** and **CCB3** simultaneously for **50 ms**.

✓ The LEDs 1 to 4 will show present setting using a running light:

- **Slow tripping characteristic** is indicated by a slow running light.
- **Fast tripping characteristic** is indicated by a fast running light.

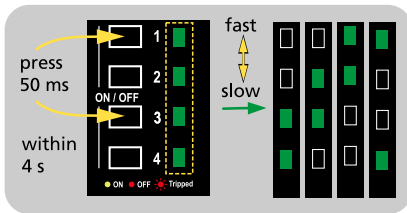

⇒ To select tripping characteristic press **CCB1** and **CCB3** simultaneously for **50 ms within 4 s**.

✓ The LEDs 1 to 4 will show updated setting.

i The setting is saved automatically.

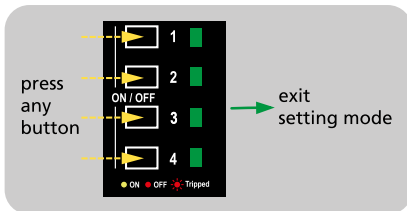

⇒ To exit setting mode press any button (except CCB1 and CCB3 simultaneously).

9. Change Power Supply Overload Protection

The PISA-M offers a Power Supply Overload Protection to avoid voltage dips caused by overloaded output channels. To ensure high flexibility for different types of loads, the sensitivity of the Power Supply Overload Protection can be configured.

The following modes are available:

- **High sensitivity:** For sensitive loads such as PLC controller or sensors. The overloaded output channel will trip if the supply voltage falls below the activation threshold for > 0.4 ms.
- **Low sensitivity:** For capacitive loads and devices which are not sensitive to short voltage drops. The overloaded output channel will trip if the supply voltage falls below the activation threshold for > 2 ms.
- **Disabled:** The Power Supply Protection Mode can be turned off. Use this mode for huge capacitive loads and devices which are not sensitive to supply voltage dips.

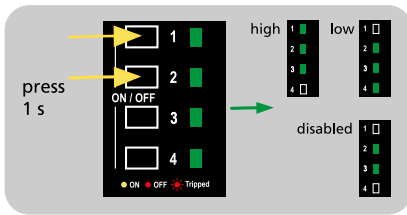

⇒ Press **CCB1** and **CCB2** simultaneously for **1 s**.

✓ The LEDs 1 to 4 will show the present setting.

- Option 1: **High sensitivity** LED 1 + LED 2 + LED 3 green
- Option 2: **Low sensitivity** LED 2 + LED 3 + LED 4 green
- Option 3: **Disabled** LED 2 + LED 3 green

i The device will exit the setting mode automatically after **4 s** inactivity.

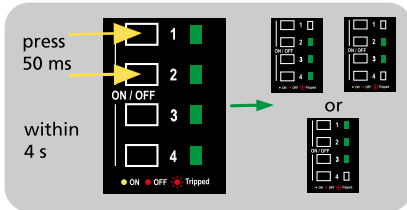

⇒ To change the setting press **CCB1** and **CCB2** simultaneously for **50 ms within 4 s**.

✓ The LEDs 1 to 4 show the updated setting.

i The setting is saved automatically.

10. Set Button Reaction Style



- Affects all Channel Control Buttons.
- The device will exit setting mode automatically after **4 s** inactivity.

The required duration of button press to turn an output channel ON or OFF can be configured. In **standard mode** an output channel is switched ON or OFF by pressing the related CCB for **50 ms**. In **long press mode** an output channel is switched ON or OFF by pressing the related CCB for **1 s**.

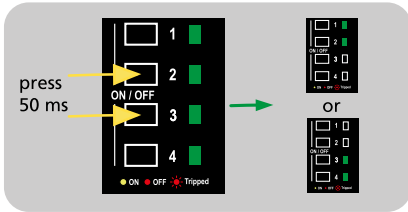

Check the currently set button reaction style:

- ⇒ Press **CCB2** and **CCB3** simultaneously for **50 ms**.
- ✓ The LEDs 1 to 4 will show the present settings.

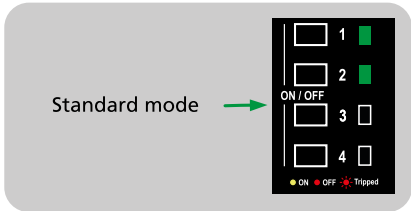

Standard mode LED 1 and LED 2 green
LED 3 and LED 4 OFF

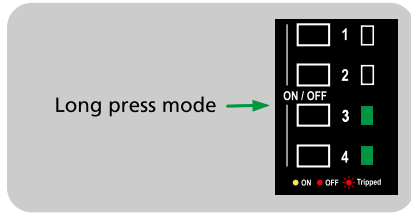

Long press mode LED 1 and LED 2 OFF
LED 3 and LED 4 green

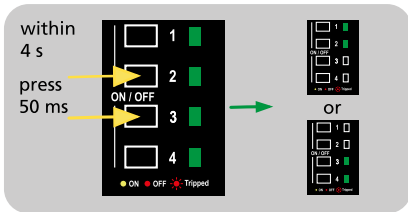

⇒ To change the button reaction style press **CCB2** and **CCB3** simultaneously for **50 ms within 4 s**.

✓ The LEDs will show the updated setting.

i The setting is saved automatically.

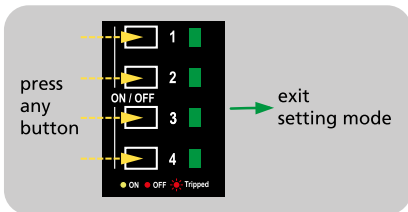

⇒ To exit setting mode press any button (except CCB2 and CCB3 simultaneously).

11. Reset Tripped Output Channels

11.1. Remotely Reset via Control Input

Tripped output channels can be reset via the control input pin 3.3 (+) and 3.4 (-) once the root-cause of the tripped output channel has been resolved. To reset, a voltage between 10-30 Vdc must be applied to the control input for ≥ 1 s.



- Make sure that the current sum is ≤ 20 A and no output channel is overloaded.
- The Remote-Reset Signal (10-30 V for ≥ 1 s) does not work if communication mode is set to bidirectional Digital Coded Interface, see product datasheet for details.
- The Reset Signal does only reset tripped output channels. Output channels that are manually turned off will not be reactivated.

11.2. Manually Reset at Front Side User Elements

- Make sure that the current sum is ≤ 20 A and no output channel is overloaded.

Tripped output channels can be reset via the Front Side User Elements once the root-cause of the tripped output channel has been resolved.

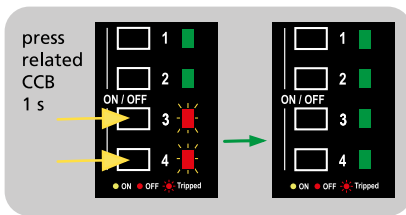

- ⇒ To reset an overloaded output channel press the **related CCB for 1 s**.
- ✓ The associated LED will turn green.

12. Select Communication Mode

i The device will exit setting mode automatically after **4 s** inactivity.

The device is equipped with two signal ports. Signal status output (pin 3.1 – 3.2) and signal control input (pin 3.3 – 3.4). These ports can be configured as follows:

Tripping Alarm:

Switch closes when at least one or more output channels are tripped.

- Status Signal Output ON → one or more output channels are tripped
- Status Signal Output OFF → no output channel tripped

Digital Coded Interface (DCI):

For more detailed information regarding DCI mode, please refer to the product datasheet.

Output Channel Off Alarm:

Switch closes when one or more channels are tripped or manually turned off.

- Status Signal Output ON → one or more output channels are tripped / turned off
- Status Signal Output OFF → all output channels are turned on

OK-Signal:

Switch closes if all output channels are turned on.

- Status Signal Output ON → all output channels are turned on
- Status Signal Output OFF → one or more output channels are tripped / turned off

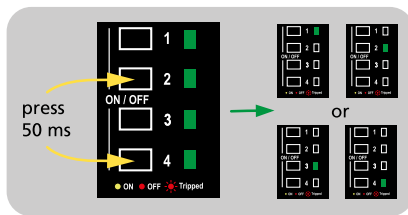

⇒ Press the buttons **CCB2** and **CCB4** simultaneously for **50 ms**.
 ✓ The LEDs 1 to 4 will show present setting.

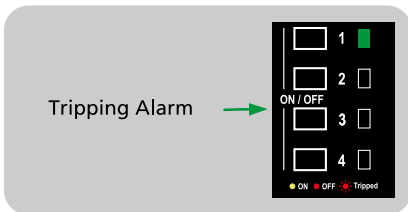

Tripping Alarm LED 1 green
all other LEDs OFF

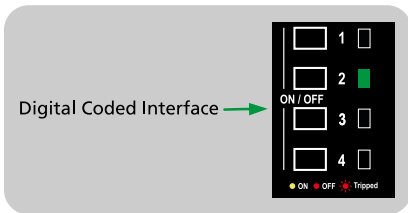

Digital Coded Interface (DCI) LED 2 green
all other LEDs OFF

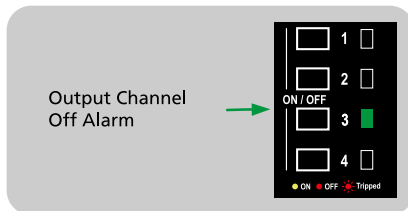

Output Channel Off Alarm LED 3 green
all other LEDs OFF

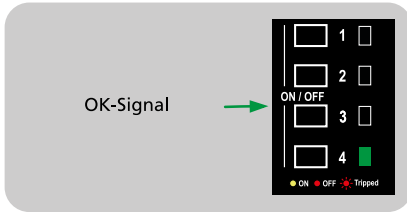

OK-Signal

LED 4 green
all other LEDs OFF

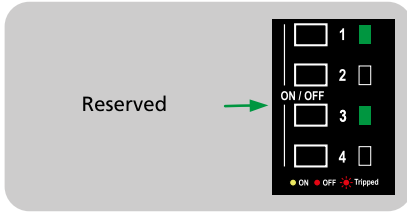

Not assigned to application interface - reserved for update to bus interface

LED 1 + LED 3 green
all other LEDs OFF

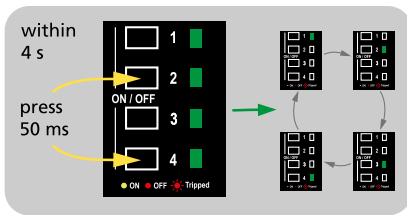

⇒ To select next communication mode press **CCB2** and **CCB4** simultaneously for **50 ms within 4 s**.

✓ The LEDs will show updated setting.

i The setting is saved automatically.

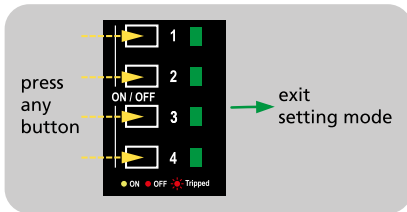

⇒ To exit setting mode press any button (except CCB2 and CCB4 simultaneously).