



POWER SUPPLY

1AC 24V 90W

- AC 100-240V Wide-range input
- Cost optimized without compromising quality or reliability
- Width only 36mm
- Efficiency up to 93.8%
- Low no-load power losses
- Full power between -10°C and +60°C
- Large screw terminals
- 3 Year warranty

PRODUCT DESCRIPTION

The PIM90.245 is a DIN rail mountable single-phase-input power supply, which provides a floating, stabilized and galvanically separated SELV/PELV/ES1 output voltage.

The device is equipped with screw terminals, which are optimized for large wire sizes.

The mechanically robust housing is made of a high-grade, reinforced molded material, which permits surrounding temperatures up to +70°C.

The PIANO family is a compact industrial grade DIN rail power supply series that focuses on the essential features needed in today's industrial applications. The excellent cost/performance ratio does not compromise quality or reliability.

SHORT-FORM DATA

Output voltage	DC 24V	Nominal
Adjustment range	24-28V	Factory setting 24.1V
Output current	3.8-3.2A 2.8-2.4A	Below +60°C ambient At +70°C ambient Derate between +60°C and +70°C
Input voltage AC	AC 100-240V	± 10%
Mains frequency	50-60Hz	±6%
Input current AC	1.45 / 0.95A	At 120 / 230Vac
Power factor	0.58 / 0.45	At 120 / 230Vac
Input inrush current	18 / 40A _{peak}	At 120 / 230Vac, +40°C, cold start
Efficiency	92.1 / 93.8%	At 120 / 230Vac
Power losses	7.9 / 6W	At 120 / 230Vac
Hold-up time	25 / 119ms	At 120 / 230Vac
Temperature range	-10°C to +70°C	
Size (w x h x d)	36x90x91mm	Without DIN rail
Weight	270g / 0.6lb	

ORDER NUMBERS

Description: Power supply PIM90.245-xx
Order Number:
 PIM90.245

MAIN APPROVALS

For details and the complete approval list, see chapter 18.



Ind. Cont. Eq.

Index



1	Intended Use.....	3	15	Environment.....	13
2	Installation Instructions.....	3	16	Safety and Protection Features.....	14
3	AC-Input.....	4	17	Dielectric Strength.....	14
4	DC-Input.....	5	18	Approved, Fulfilled or Tested Standards.....	15
5	Input Inrush Current.....	5	19	Regulatory Product Compliance.....	15
6	Output.....	6	20	Physical Dimensions And Weight.....	16
7	Hold-up Time.....	7	21	Application Notes.....	17
8	Efficiency and Power Losses.....	8	21.1	Charging of Batteries.....	17
9	Lifetime Expectancy.....	9	21.2	Series Operation.....	17
10	MTBF.....	9	21.3	Parallel Use to Increase Output Power...	17
11	Functional Diagram.....	10	21.4	Parallel Use for 1+1 Redundancy.....	17
12	Terminals And Wiring.....	10	21.5	Two Phase Operation.....	17
13	Front Side And User Elements.....	11	21.6	Use in a Tightly Sealed Enclosure.....	18
14	EMC.....	12			

The information given in this document is correct to the best of our knowledge and experience at the time of publication. If not expressly agreed otherwise, this information does not represent a warranty in the legal sense of the word. As the state of our knowledge and experience is constantly changing, the information in this data sheet is subject to revision. We therefore kindly ask you to always use the latest issue of this document (available under www.pulspower.com).

No part of this document may be reproduced or utilized in any form without our prior permission in writing.

Packaging and packaging aids can and should always be recycled. The product itself may not be disposed of as domestic refuse.

TERMINOLOGY AND ABBREVIATIONS

PE and  Symbol	PE is the abbreviation for Protective Earth and has the same meaning as the symbol  .
Earth, Ground	This document uses the term "earth" which is the same as the U.S. term "ground".
t.b.d.	To be defined, value or description will follow later.
AC 230V	A figure displayed with the AC or DC before the value represents a nominal voltage with standard tolerances (usually $\pm 15\%$) included. E.g.: DC 12V describes a 12V battery disregarding whether it is full (13.7V) or flat (10V)
230Vac	A figure with the unit (Vac) at the end is a momentary figure without any additional tolerances included.
50Hz vs. 60Hz	As long as not otherwise stated, AC 100V and AC 230V parameters are valid at 50Hz mains frequency. AC 120V parameters are valid for 60Hz mains frequency.
may	A key word indicating flexibility of choice with no implied preference.
shall	A key word indicating a mandatory requirement.
should	A key word indicating flexibility of choice with a strongly preferred implementation.

1. Intended Use

This device is designed for installation in an enclosure and is intended for commercial use, such as in industrial control, process control, monitoring, measurement, Audio/Video, information or communication equipment or the like.

Do not use this device in equipment, where malfunctioning may cause severe personal injury or threaten human life without additional appropriate safety devices, that are suited for the end-application. If this device is used in a manner outside of its specification, the protection provided by the device may be impaired.

Do not use this device on AC 100V mains with more than 2.9A load when the application is sensitive to short output voltage dips during mains interruptions even with a length shorter than 20ms.

Without additional measures to reduce the conducted emissions on the output (e.g. by using a filter), the device is not suited to supply a local DC power network in residential, commercial and light-industrial environments. No restrictions apply for local DC power networks in industrial environments.

2. Installation Instructions

⚠ DANGER Risk of electrical shock, fire, personal injury or death.

- Turn power off before working on the device. Protect against inadvertent re-powering.
- Do not open, modify or repair the device.
- Use caution to prevent any foreign objects from entering the housing.
- Do not use in wet locations or in areas where moisture or condensation can be expected.
- Do not touch during power-on, and immediately after power-off. Hot surfaces may cause burns.

Obey the following installation instructions:

This device may only be installed and put into operation by qualified personnel. This device does not contain serviceable parts. The tripping of an internal fuse is caused by an internal defect. If damage or malfunction should occur during installation or operation, immediately turn power off and send unit to the factory for inspection.

Install device in an enclosure providing protection against electrical, mechanical and fire hazards. Install the device onto a DIN rail according to EN 60715 with the input terminals on the bottom of the device.

Make sure that the wiring is correct by following all local and national codes. Use appropriate copper cables that are designed for a minimum operating temperature of +60°C for ambient temperatures up to +45°C, +75°C for ambient temperatures up to +60°C and +90°C for ambient temperatures up to +70°C. Ensure that all strands of a stranded wire enter the terminal connection. Unused screw terminals should be securely tightened.

The device is designed for pollution degree 2 areas in controlled environments. No condensation or frost is allowed. The enclosure of the device provides a degree of protection of IP20. The enclosure does not provide protection against spilled liquids.

The device is designed for overvoltage category II zones. Below 2000m altitude the device is tested for impulse withstand voltages up to 4kV, which corresponds to OVC III according to IEC 60664-1.

The device is designed as "Class of Protection" I equipment according to IEC 61140. Do not use without a proper PE (Protective Earth) connection.

The device is suitable to be supplied from TN, TT or IT mains networks. The continuous voltage between the input terminal and the PE potential must not exceed 300Vac. A disconnecting means shall be provided for the input of the device.

The device is designed for convection cooling and does not require an external fan. Do not obstruct airflow and do not cover ventilation grid!

The device is designed for altitudes up to 5000m (16 400ft). Above 2000m (6560ft) a reduction in output current is required.

Keep the following minimum installation clearances: 40mm on top, 20mm on the bottom, 0mm left and right side. Increase the 0mm to 15mm in case the adjacent device is a heat source.

The device is designed, tested and approved for branch circuits up to 20A without additional protection device. If an external fuse is utilized, do not use circuit breakers smaller than 6A B- or 4A C-Characteristic to avoid a nuisance tripping of the circuit breaker.

The maximum surrounding air temperature is +70°C (158°F). The operational temperature is the same as the ambient or surrounding air temperature and is defined 2cm below the device. The device is designed to operate in areas between 5% and 95% relative humidity.

3. AC-Input

The device is suitable to be supplied from TN, TT or IT mains networks.

AC input	nom.	AC 100-240V	
AC input range		90-264Vac	Continuous operation
		264-300Vac	For maximum 500ms
Allowed voltage L or N to earth	max.	300Vac	Continuous, according to IEC 62477-1
Input frequency	nom.	50-60Hz	±6%
Turn-on voltage	typ.	75Vac	Steady-state value, see Fig. 3-1
Shut-down voltage	typ.	54Vac	Steady-state value, see Fig. 3-1
External input protection	See recommendations in chapter 2.		

		AC 100V	AC 120V	AC 230V	
Input current	typ.	1.69A	1.45A	0.95A	At 24V, 3.8A, see Fig. 3-1
Power factor	typ.	0.6	0.58	0.45	At 24V, 3.8A, see Fig. 3-4
Start-up delay	typ.	50ms	50ms	50ms	See Fig. 3-2
Rise time	typ.	21ms	21ms	20ms	At 24V, 3.8A constant current load, 0mF load capacitance, see Fig. 3-2
	typ.	42ms	42ms	40ms	At 24V, 3.8A constant current load, 2mF load capacitance, see Fig. 3-2
Turn-on overshoot	max.	100mV	100mV	100mV	See Fig. 3-2

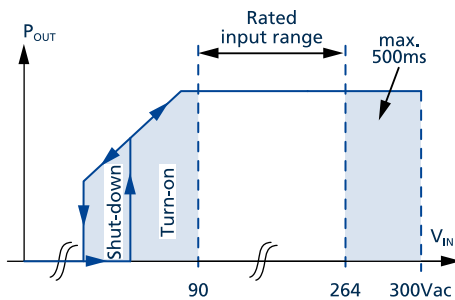

Fig. 3-1: Input voltage range

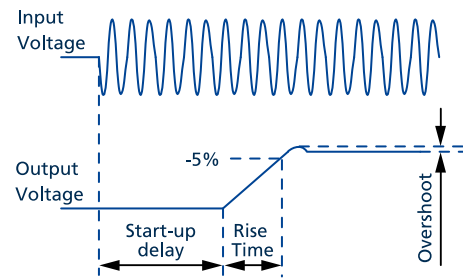

Fig. 3-2: Turn-on behavior, definitions

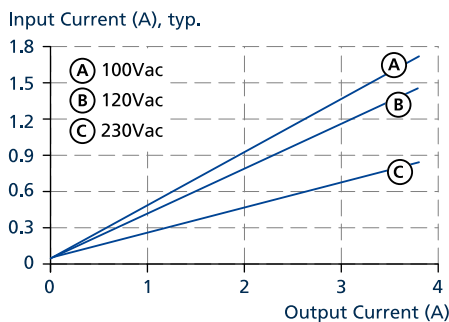

Fig. 3-3: Input current vs. output load at 24V output voltage

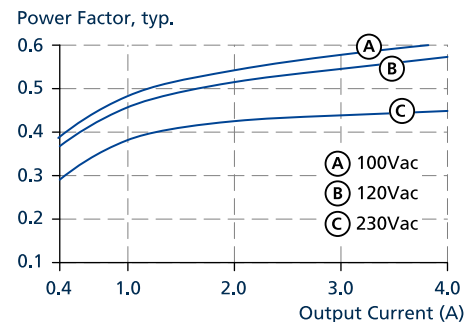

Fig. 3-4: Power factor vs. output load at 24V output voltage

All parameters are specified at 24V, 3.8A, 230Vac, 25°C ambient and after a 5 minutes run-in time unless otherwise noted.

4. DC-Input

Do not operate this device with DC-input voltage.

5. Input Inrush Current

A NTC limits the input inrush current after turn-on of the input voltage. The inrush current is input voltage and ambient temperature dependent. The output load has no impact on the inrush current value.

The charging current into EMI suppression capacitors is disregarded in the first microseconds after switch-on.

		AC 100V	AC 120V	AC 230V	
Inrush current I_{peak}	typ.	14A	18A	40A	At 40°C, ambient, cold start
	typ.	12A	16A	35A	At 25°C, ambient, cold start
	max.	17A	22A	48A	At 40°C, ambient, cold start
	max.	15A	20A	43A	At 25°C, ambient, cold start
Inrush energy I^2t	max.	0.3A ² s	0.4A ² s	1.7A ² s	At 40°C, ambient, cold start

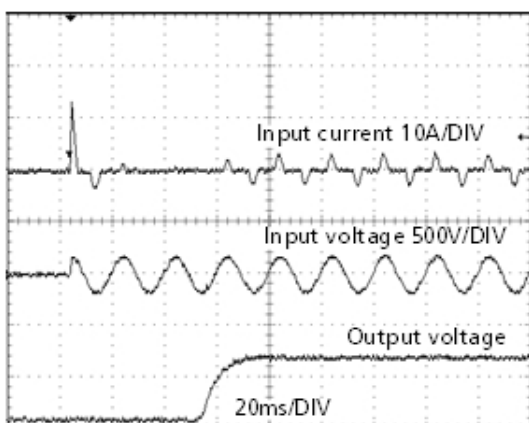

Fig. 5-1: Typical turn-on behavior at 120Vac and 25°C ambient

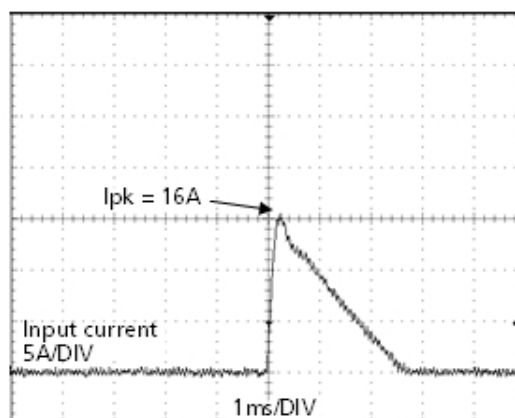

Fig. 5-2: Zoom into the first inrush peak

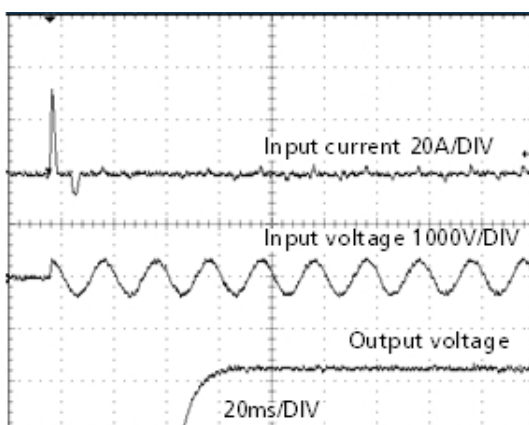

Fig. 5-3: Typical turn-on behavior at 230Vac and 25°C ambient

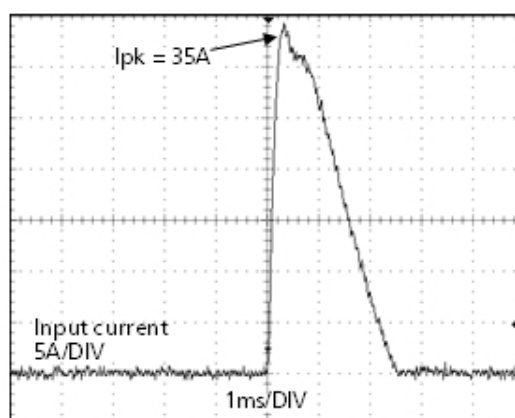

Fig. 5-4: Zoom into the first inrush peak

6. Output

The output provides a SELV/PELV/ES1 rated voltage, which is galvanically isolated from the input voltage. The output is electronically protected against no-load, overload and short circuit. In case of a protection event, audible noise may occur. The output is designed to supply any kind of loads, including inductive and capacitive loads. Capacitive loads should not be larger than 4 000µF with 3.8A or 5 000µF with 1.9A additional resistive load.

At heavy overloads (when output voltage falls below 14V), the device delivers continuous output current for 20ms. After this, the output is switched off for approx. 160ms before a new start attempt is automatically performed. This cycle is repeated as long as the overload exists.

If the overload has been cleared, the device will operate normally.

Output voltage	nom.	DC 24V	
Adjustment range		24-28V	Guaranteed value
	max.	29.5V	This is the maximum output voltage which can occur at the clockwise end position of the potentiometer due to tolerances. It is not a guaranteed value which can be achieved.
Factory settings	typ.	24.1V	±0,2%, at full load, cold unit
Line regulation	max.	10mV	Between 90 and 300Vac
Load regulation	max.	100mV	Between 0 and 3.8A, static value, see Fig. 6-1
Ripple and noise voltage	max.	100mVpp	Bandwidth 20Hz to 20MHz, 50Ohm
Output current	nom.	3.8A	At 24V and an ambient temperature below 60°C
	nom.	2.8A	At 24V and 70°C ambient temperature
	nom.	3.2A	At 28V and an ambient temperature below 60°C
	nom.	2.4A	At 28V and 70°C ambient temperature
Overload protection	Included		Electronically protected against no-load, overload and short circuit. In case of a protection event, audible noise may occur.
Overload behaviour	Continuous current		For output voltage above 14Vdc, see Fig. 6-1
	Intermittent current		For output voltage below 14Vdc, see Fig. 6-2
Overload/short-circuit current	max.	6.7A	Continuous current, see Fig. 6-1
	typ.	8.6A	Intermittent current peak value for typ. 20ms Load impedance 150mOhm, see Fig. 6-2 Discharge current of output capacitors is not included.
	max.	3.2A	Intermittent current average value (R.M.S.) Load impedance 150mOhm, see Fig. 6-2
Output capacitance	typ.	1 600µF	Included inside the device
Back-feeding loads	max.	35V	The unit is resistant and does not show malfunctioning when a load feeds back voltage to the device. It does not matter whether the device is on or off. The absorbing energy can be calculated according to the built-in large sized output capacitor.

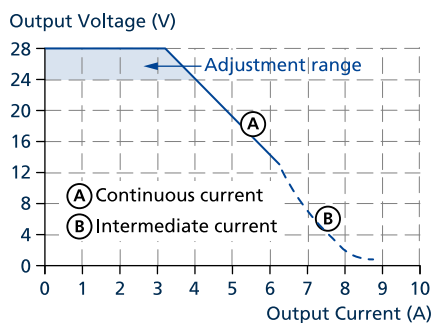

Fig. 6-1: Output voltage vs. output current, typ.

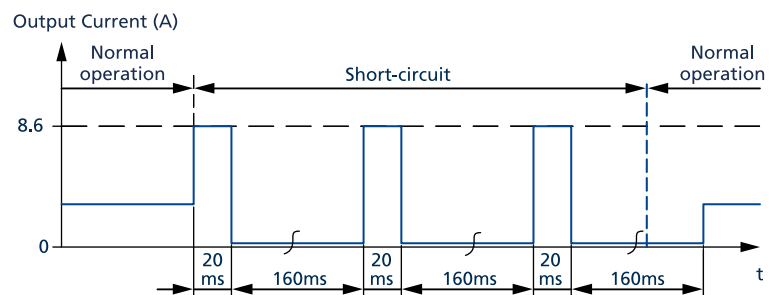

Fig. 6-2: Intermittent current at short circuit, typ.*)

*) with cold devices the times are about 15% longer.

7. Hold-up Time

The hold-up time is the time during which a device's output voltage remains within specification following the loss of input power. The hold-up time is output load dependent. At no load, the hold-up time can be up to several seconds. The green DC-OK LED is also on during this time.

		AC 100V	AC 120V	AC 230V	
Hold-up time	typ.	14ms	25ms	119ms	At 24V, 3.8A
	typ.	40ms	60ms	242ms	At 24V, 1.9A
	min.	11.5ms	20ms	95ms	At 24V, 3.8A
	min.	32ms	48ms	194ms	At 24V, 1.9A

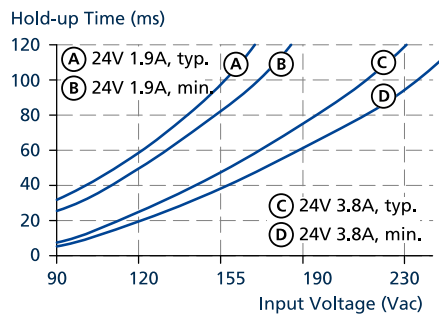

Fig. 7-1: Hold-up time vs. input voltage

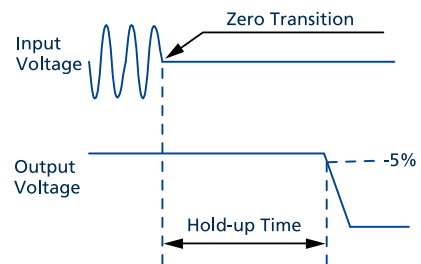

Fig. 7-2: Shut-down behaviour, definitions

8. Efficiency and Power Losses

		AC 100V	AC 120V	AC 230V	
Efficiency	typ.	90.6%	92.1%	93.8%	At 24V, 3.8A (full load)
Average efficiency	typ.	90.5%	91.6%	92%	25% at 0.95A, 25% at 1.9A, 25% at 2.85A, 25% at 3.8A
Power losses	typ.	0.3W	0.3W	0.4W	At no load
	typ.	5W	4.3W	3.8W	At 24V, 1.9A (half load)
	typ.	9.5W	7.9W	6W	At 24V, 3.8A (full load)

The average efficiency is an assumption for a typical application where the device is loaded with 25% of the nominal load for 25% of the time, 50% of the nominal load for another 25% of the time, 75% of the nominal load for another 25% of the time and with 100% of the nominal load for the rest of the time.

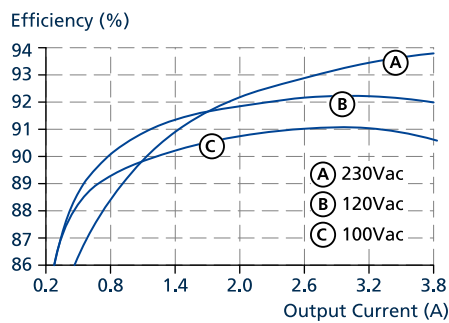

Fig. 8-1: Efficiency vs. output current at 24V, typ.

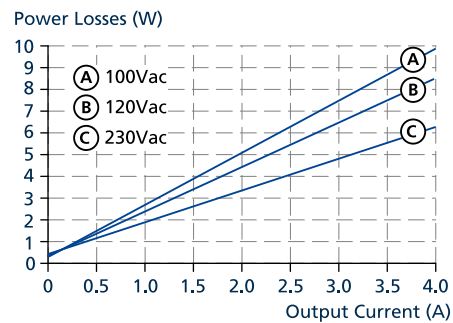

Fig. 8-2: Losses vs. output current at 24V, typ.

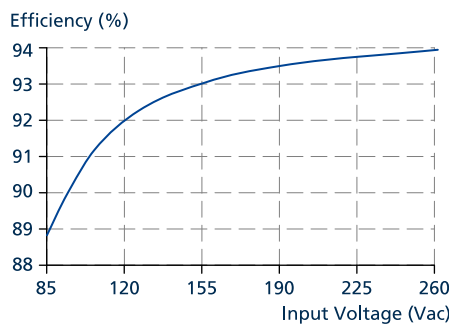

Fig. 8-3: Efficiency vs. input voltage at 24V, 3.8A, typ.

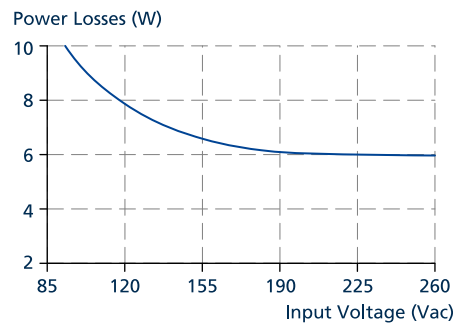

Fig. 8-4: Losses vs. input voltage at 24V, 3.8A, typ.

9. Lifetime Expectancy

The Lifetime expectancy shown in the table indicates the minimum operating hours (service life) and is determined by the lifetime expectancy of the built-in electrolytic capacitors. Lifetime expectancy is specified in operational hours and is calculated according to the capacitor's manufacturer specification.

Please note: The manufacturer of the electrolytic capacitors only guarantees a maximum life of up to 15 years (131 400h). Any number exceeding this value is a calculated theoretical lifetime which can be used to compare devices.

	AC 100V	AC 120V	AC 230V	
Lifetime expectancy	39 000h	64 000h	102 000h	At 24V, 3.8A and 40°C
	260 000h	292 000h	309 000h	At 24V, 1.9A and 40°C
	91 000h	147 000h	287 000h	At 24V, 3.8A and 25°C
	640 000h	720 000h	815 000h	At 24V, 1.9A and 25°C

10. MTBF

MTBF stands for **Mean Time Between Failure**, which is calculated according to statistical device failures, and indicates reliability of a device. It is the statistical representation of the likelihood of a unit to fail and does not necessarily represent the life of a product.

The MTBF figure is a statistical representation of the likelihood of a device to fail. A MTBF figure of e.g. 1 000 000h means that statistically one unit will fail every 100 hours if 10 000 units are installed in the field. However, it cannot be determined if the failed unit has been running for 50 000h or only for 100h.

For these types of units the MTTF (**Mean Time To Failure**) value is the same value as the MTBF value.

	AC 100V	AC 120V	AC 230V	
MTBF SN 29500, IEC 61709	1 174 000h	1 273 000h	1 507 000h	At 24V, 3.8A and 40°C
	2 251 000h	2 406 000h	2 752 000h	At 24V, 3.8A and 25°C
MTBF MIL HDBK 217F	751 000h	760 000h	698 000h	At 24V, 3.8A and 40°C; Ground Benign GB40
	1 085 000h	1 099 000h	1 018 000h	At 24V, 3.8A and 25°C; Ground Benign GB25
	219 000h	224 000h	220 000h	At 24V, 3.8A and 40°C; Ground Fixed GF40
	288 000h	294 000h	293 000h	At 24V, 3.8A and 25°C; Ground Fixed GF25

11. Functional Diagram

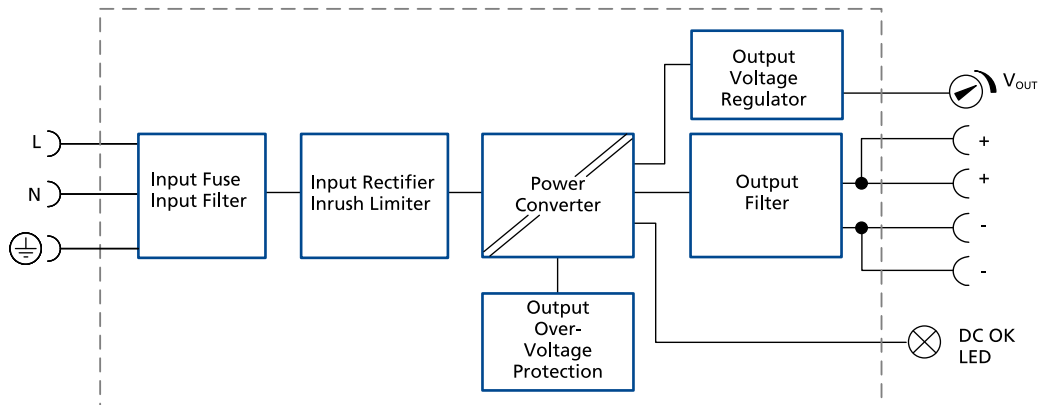

Fig. 11-1: Functional diagram

12. Terminals And Wiring

The terminals are IP20 Finger safe constructed and suitable for field- and factory wiring.

All Terminals	
Type	Screw terminals
Solid wire	max. 6mm ²
Stranded wire	max. 4mm ²
American Wire Gauge	AWG 20-10
Max. wire diameter (including ferrules)	2.8mm
Wire stripping length	7mm / 0.28inch
Recommended tightening torque	1Nm, 9lb.in
Screwdriver	3mm slotted or Phillips No 1

13. Front Side And User Elements

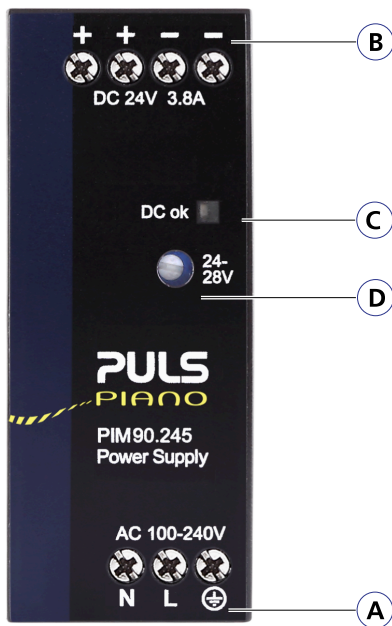

A Input Terminals

- N Neutral conductor input
- L Phase (Line) input
- ⊕ PE (Protective Earth)

B OutputTerminals

Dual terminals for the negative and positive pole. Both poles are internally connected.

- + Positive output
- Negative (return) output

C DC OK LED (green)

The LED is on, when the output voltage is above 18V.

D Output voltage adustment potentiometer

Fig. 13-1: Front side

14. EMC

The EMC behavior of the device is designed for applications in industrial environment as well as in residential, commercial and light industry environments.

The device complies with EN 61000-6-1, EN 61000-6-2, EN 61000-6-3, EN 61000-6-4, EN 61000-3-2 and EN 61000-3-3. The device complies with FCC Part 15 rules. Operation is subjected to following two conditions: (1) this device may not cause harmful interference, and (2) this device must accept any interference received, including interference that may cause undesired operation.

Do not use this device on AC 100V mains with more than 2.9A load when the application is sensitive to short output voltage dips during mains interruptions even with a length shorter than 20ms. Without additional measures to reduce the conducted emissions on the output (e.g. by using a filter), the device is not suited to supply a local DC power network in residential, commercial and light-industrial environments. No restrictions apply for local DC power networks in industrial environments.

EMC Immunity

Electrostatic discharge	EN 61000-4-2	Contact discharge	8kV	Criterion A
		Air discharge	8kV	Criterion A
Electromagnetic RF field	EN 61000-4-3	80MHz - 6GHz	10V/m	Criterion A
Fast transients (Burst)	EN 61000-4-4	Input lines	4kV	Criterion A
		Output lines	2kV	Criterion A
Surge voltage on input	EN 61000-4-5	L → N	2kV	Criterion A
		N / L → PE	4kV	Criterion A
Surge voltage on output	EN 61000-4-5	(+) → (-)	1kV	Criterion A
		(+) / (-) → PE	1kV	Criterion A
Conducted disturbance	EN 61000-4-6	0.15 - 80MHz	10V	Criterion A
Voltage dips	EN 61000-4-11	0% of 100Vac	0Vac, 20ms	Criterion A/C
		40% of 100Vac	40Vac, 200ms	Criterion C
		70% of 100Vac	70Vac, 500ms	Criterion A
		0% of 120Vac	0Vac, 20ms	Criterion A
		40% of 120Vac	48Vac, 200ms	Criterion C
		70% of 120Vac	84Vac, 500ms	Criterion A
		0% of 200Vac	0Vac, 20ms	Criterion A
		40% of 200Vac	80Vac, 200ms	Criterion A
70% of 200Vac	140Vac, 500ms	Criterion A		
Voltage interruptions	EN 61000-4-11	0V	5000ms	Criterion C
Powerful transients	VDE 0160	Over entire load range	750V, 1.3ms	Criterion A

Performance criterions:

- A:** The device shows normal operation behavior within the defined limits.
- B:** The device operates continuously during and after the test. During the test minor temporary impairments may occur, which will be corrected by the device itself.
- C:** Temporary loss of function is possible. The device may shut-down and restarts by itself. No damage or hazards for the device will occur.

A/C: Criterion A for output current below 2.9A and criterion C for output currents above 2.9A.

EMC Emission

Conducted emission input lines	EN 55011, EN 55032, FCC Part 15, CISPR 11, CISPR32	Class B
Conducted emission output lines	IEC/CISPR 16-1-2, IEC/CISPR 16-2-1	Limits for local DC power networks not fulfilled.
Radiated emission	EN 55011, EN 55032, CISPR 11, CISPR 32	Class B
Harmonic input current	EN 61000-3-2	Fulfilled (Class A)
Voltage fluctuations, flicker	EN 61000-3-3	Fulfilled, tested with non pulsing constant current loads.

Switching Frequencies

Main converter	5kHz to 120kHz	Input voltage and output load dependent
----------------	----------------	---

15. Environment

Operational temperature	-10°C to +70°C (14°F to 158°F)	The operational temperature is the ambient or surrounding temperature and is defined as the air temperature 2cm below the device.
Storage temperature	-40°C to +85°C (-40°F to 185°F)	For storage and transportation
Output derating	0.1A/°C 0.25A/1000m or 5°C/1000m The derating is not hardware controlled. The user has to take this into consideration to stay below the derated current limits in order not to overload the unit.	Between +60°C and +70°C (140°F to 158°F) For altitudes >2000m (6560ft), see Fig. 15-2
Humidity	5 to 95% r.h.	According to IEC 60068-2-30 No condensation allowed.
Atmospheric pressure	110-47kPa	See Fig. 15-2 for details
Altitude	Up to 5000m (16 400ft)	See Fig. 15-2 for details
Over-voltage category	III II	According to IEC 60664-1, for altitudes <2000m According to IEC 60664-1, for altitudes >2000m
Degree of pollution	2	According to 62477-1, non conductive
Vibration sinusoidal	2-17.8Hz: ±1.6mm 17.8-500Hz: 2g 2 hours / axis	According to IEC 60068-2-6
Shock	30g 6ms, 20g 11ms 3 bumps / direction, 18 bumps in total Shock and vibration is tested in combination with DIN rails according to EN 60715 with a height of 15mm and a thickness of 1.3mm.	According to IEC 60068-2-27
Audible noise	Some audible noise may be emitted from the power supply during no load, overload or short circuit.	

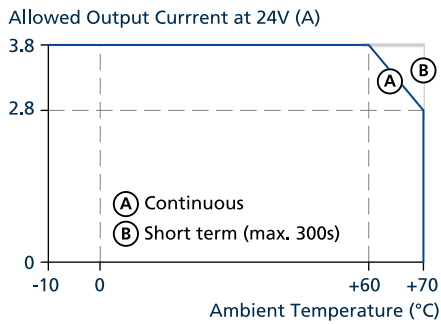

Fig. 15-1: Output power vs. ambient temp.

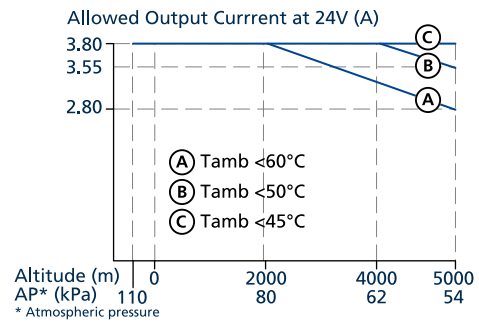

Fig. 15-2: Output power vs. altitude

16. Safety and Protection Features

Isolation resistance	>500MΩ	At delivered condition between input and output, measured with 500Vdc
	>500MΩ	At delivered condition between input and PE, measured with 500Vdc
	>500MΩ	At delivered condition between output and PE, measured with 500Vdc
Output over-voltage protection	typ. 30.5Vdc max. 32Vdc In case of an internal defect, a redundant circuit limits the maximum output voltage to 32V. The output shuts down. To attempt a restart, turn the input power off for at least 90s.	
Class of protection	I	According to IEC 61140
Degree of protection	IP20	According to EN/IEC 60529
Over-temperature protection	Not Included	
Input transient protection	MOV (Metal Oxide Varistor)	For protection values see chapter 14 (EMC).
Internal input fuse	Included	Not user replaceable slow-blow high-braking capacity fuse
Touch current (leakage current)	typ. 30μA / 60μA	At 100Vac, 50Hz, TN-, TT-mains / IT-mains
	typ. 40μA / 90μA	At 120Vac, 60Hz, TN-, TT-mains / IT-mains
	typ. 70μA / 140μA	At 230Vac, 50Hz, TN-, TT-mains / IT-mains
	max. 40μA / 70μA	At 110Vac, 50Hz, TN-, TT-mains / IT-mains
	max. 50μA / 110μA	At 132Vac, 60Hz, TN-, TT-mains / IT-mains
	max. 90μA / 180μA	At 264Vac, 50Hz, TN-, TT-mains / IT-mains

17. Dielectric Strength

The output voltage is floating and has no ohmic connection to the ground.

It is recommended that either the (+) pole or the (-) pole shall be connected to the protective earth system. This helps to avoid situations in which a load starts unexpectedly or can not be switched off when unnoticed earth faults occur.

Type and routine tests are conducted by the manufacturer. Field tests may be conducted in the field using the appropriate test equipment which applies the voltage with a slow ramp (2s up and 2s down). Connect all phase-terminals together as well as all output poles before conducting the test. When testing, set the cut-off current settings to the value in the table below.

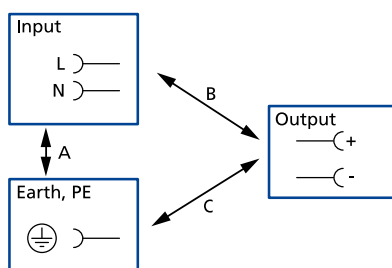

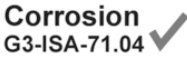







Fig. 17-1: Dielectric strength

		A	B	C
Type test	60s	2500Vac	3000Vac	1000Vac
Factory test	5s	2500Vac	2500Vac	500Vac
Field test	5s	2000Vac	2000Vac	500Vac
Field test cut-off current settings		>2mA	>2mA	>6mA

18. Approved, Fulfilled or Tested Standards

IEC 61010	CB Report	CB Scheme Certificate IEC 61010-2-201 - Electrical Equipment for Measurement, Control and Laboratory Use - Particular requirements for control equipment
IEC 62368	CB Report	CB Scheme Certificate IEC 62368-1 - Audio/video, information and communication technology equipment - Safety requirements Output safety level: ES1
UL 61010		UL Certificate Listed equipment for category NMTR - UL 61010-2-201 - Electrical equipment for measurement, control and laboratory use - Particular requirements for control equipment Applicable for US and Canada E-File: E198865
IEC 61558-2-16 (Annex BB)	Safety Isolating Transformer	Test Certificate IEC 61558-2-16 - Safety of transformers, reactors, power supply units and similar products for supply voltages up to 1100V Particular requirements and tests for switch mode power supply units and transformers for switch mode power supply units
ISA-71.04-1985		Manufacturer's Declaration (Online Document) Airborne Contaminants Corrosion Test Severity Level: G3 Harsh H2S: 100ppb NOx: 1250ppb Cl2: 20ppb SO2: 300ppb Test Duration: 3 weeks, which simulates a service life of at least 10 years
VDMA 24364		Paint Wetting Impairment Substances Test (or LABS-Test) Tested for Zone 2 and Test Class C1 according to VDMA 24364-C1-LW for solvents and water-based paints

19. Regulatory Product Compliance

EU Declaration of Conformity		The CE mark indicates conformance with the European <ul style="list-style-type: none"> - EMC directive - Low-voltage directive (LVD) - RoHS directive
KC		KC Registration Korean registration of Broadcasting and Communication Equipment Registered under Clause 3, Article 58-2 of Radio Waves Act.
REACH Regulation		Manufacturer's Declaration EU Regulation regarding the Registration, Evaluation, Authorization and Restriction of Chemicals EU Regulation 1907/2006
EAC TR Registration		EAC Certificate EAC EurAsian Conformity - Registration Russia, Kazakhstan and Belarus 8504408200, 8504409000

20. Physical Dimensions And Weight

Width	36mm / 1.42"
Height	90mm / 3.54"
Depth	91mm / 3.58"
	The DIN rail height must be added to the unit depth to calculate the total required installation depth.
Weight	270g / 0.6lb
DIN rail	Use 35mm DIN rails according to EN 60715 or EN 50022 with a height of 7.5 or 15mm.
Housing material	High-grade polycarbonate / ABS blend material
Installation clearances	See chapter 2.
Penetration protection	Small parts like screws, nuts, etc. with a diameter larger than 4.2mm.

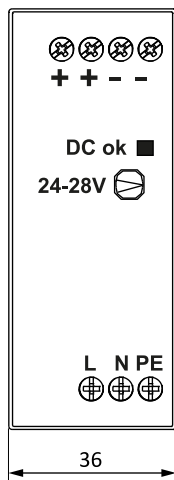

Fig. 20-1: Front view

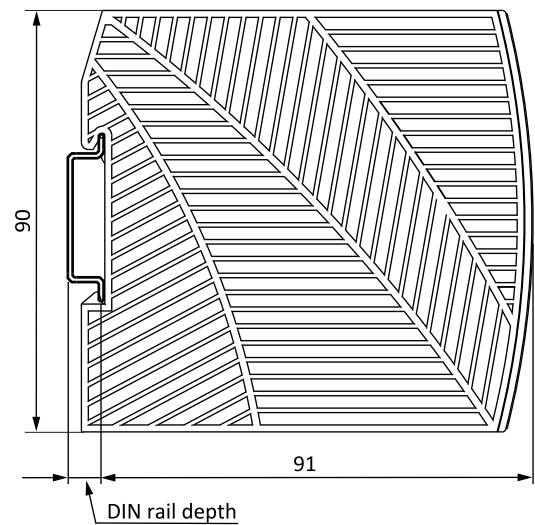

Fig. 20-2: Side view

All dimensions in mm unless otherwise noted.

21. Application Notes

21.1. CHARGING OF BATTERIES

Do not use the power supply to charge batteries.

21.2. SERIES OPERATION

Power supplies of the same type can be connected in series for higher output voltages. It is possible to connect as many units in series as needed, providing the sum of the output voltage does not exceed 150Vdc. Voltages with a potential above 60Vdc must be installed with a protection against touching.

Avoid return voltage (e.g. from a decelerating motor or battery) which is applied to the output terminals.

Keep an installation clearance of 15mm (left / right) between two power supplies and avoid installing the power supplies on top of each other.

Do not use power supplies in series in mounting orientations other than the standard mounting orientation.

Pay attention that leakage current, EMI, inrush current, harmonics will increase when using multiple power supplies.

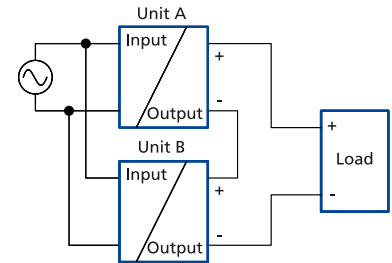

21.3. PARALLEL USE TO INCREASE OUTPUT POWER

Do not use this devices in parallel to increase the output power.

21.4. PARALLEL USE FOR 1+1 REDUNDANCY

Devices can be paralleled for 1+1 redundancy to gain higher system availability. Redundant systems require a certain amount of extra power to support the load in case one device fails. The simplest way is to put two devices in parallel. This is called a 1+1 redundancy. In case one device fails, the other one is automatically able to support the load current without any interruption. It is essential to use a redundancy module to decouple devices from each other. This prevents that the defective unit becomes a load for the other device and the output voltage cannot be maintained any more.

This device does not incorporate means to report a defective or non functional power supply. Since this is essential for redundant systems, chose a redundancy module which monitors and reports an insufficient input voltage or use a power supply, which has a DC-OK signal included.

21.5. TWO PHASE OPERATION

The power supply can also be operated on two phases of a three-phase-system. Such a phase-to-phase connection is allowed as long as the supplying voltage is below 240V^{+10%}.

Ensure that the wire, which is connected to the N-terminal, is appropriately fused.

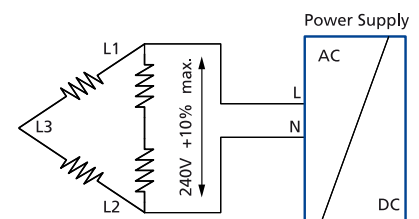

21.6. USE IN A TIGHTLY SEALED ENCLOSURE

When the power supply is installed in a tightly sealed enclosure, the temperature inside the enclosure will be higher than outside. In such situations, the inside temperature defines the ambient temperature for the power supply.

The power supply is placed in the middle of the box, no other heat producing items are inside the box. The temperature sensor inside the box is placed in the middle of the right side of the power supply with a distance of 1cm. The following measurement results can be used as a reference to estimate the temperature rise inside the enclosure.

	Case A	Case B
Enclosure size	110x180x165mm Rittal Typ IP66 Box PK 9516 100 plastic	110x180x165mm Rittal Typ IP66 Box PK 9516 100 plastic
Input voltage	230Vac	230Vac
Load	24V, 3.04A; (=80%)	24V, 3.8A; (=100%)
Temperature inside the box	34.2°C	35.9°C
Temperature outside the box	24.9°C	25.2°C
Temperature rise	9.3K	10.7K