

Redundancy in square

SLR10.100

- Input: AC 230V/115V, DC 240-375 V
- Output: 24 V/10 A
- High overload current, no switch-off
- N+1 redundancy, RDY relay contact
- Robust mechanics and EMC

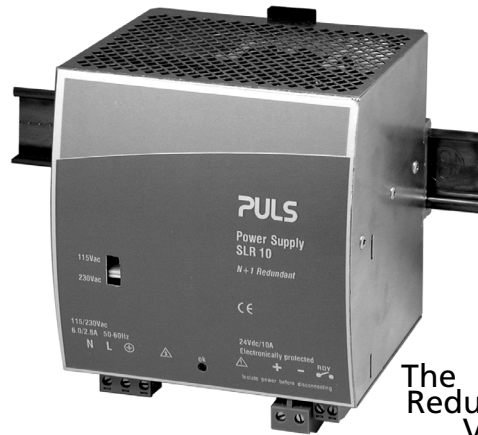

The Redundant Variant

PULS

CB
scheme
IEC60950

UL
US
UL508 LISTED
IND. CONT. EQ.
18 WM, 60°C

UL
US
UL60950 E137005
CUL/CSA-C22.2
No 950-M90

CE
EMC and
Low Volt.
Directive

Data sheet

Input

Input voltage AC100-120/220-240 V (switchable), 47-63 Hz (85-132 VAC / 176-264 VAC, 240-375 VDC)

Note: At DC input, always leave the switch in the 230V position.

Input current < 6 A (switch in 115V position)
< 2.8 A (switch in 230V position)

DCin at open output 8 mA (preserves battery sources)

Inrush current typ. < 30 A at 264 V AC and cold start

Unit is internally fused (fuse not accessible). External fuse not necessary, but recommended (common 10A, B-type 'circuit-breaker' switch used anyway to fuse the input lines).

Transient handling Transient resistance acc. to VDE 0160 / W2 (750 V / 1.3 ms), for all load conditions.

Hold-up time > 25 ms at 196 VAC, 24 V / 10 A (see diagram overleaf)

Efficiency, Reliability etc.*

Efficiency typ. 89 % (230 VAC, 24 V / 10 A)

Losses typ. 26.7 W (230 VAC, 24 V / 10 A)

MTBF 390.000 h acc. to Siemensnorm SN 29500 (24 V/10 A, 230 VAC, T_{amb} = +40 °C)

Life cycle (electrolytics) The unit exclusively uses longlife electrolytics specified for +105°C (cf. 'The SilverLine', p.2).

Start / Overload Behaviour

Start-up delay typ. 0.1 s

Rise time ca. 5-20 ms, depending on load

Overload Behaviour

- Special PULS Overload Design (see diagram overleaf)
 - no disconnection, no hiccup if overloaded
 - high overload current (up to 1.6 I_{Nom}), V_{out} is gradually reduced with increasing current.
- 20% power boost
 - 12A short-term, at 45°C or forced cooling even continuous

Advantages:

- High short-circuit current, giving large 'start-up window': unit starts reliably even with awkward loads (DC-DC converters, motors).
- No 'sticking' such as can occur with fold-back characteristics
- Secondary fuses operate reliably

Order information

Order number	Description
SLR10.100	N+1 redundancy*
SL10.100	Basic version without redundancy*
SLS10.100	Safety Cover*
SLZ01	Screw mounting set, two needed per unit

Output

Rated output voltage 24 V DC

For balanced current sharing during parallel operation:

Soft characteristic (25.2 V DC ±2% at no-load, 24 V DC ±0.5% at nominal load, almost linear characteristic curve)

Output noise suppression Radiated EMI values below EN50081-1, even when using long, unscreened output cables.

Ambient temperature range T_{amb} Operation: 0°C...+70°C (>60°C: Derating)
Storage: -25°C...+85°C

Rated continuous loading with convection cooling

- T_{amb}=0°C - 60°C 24 V / 10 A
- T_{amb}=0°C - 45°C 12 A short-term also at 60 °C

Output is protected against short circuit, open circuit and overload

Derating typ. 12 W/K (at T_{amb}=+60°C...+70°C)

Voltage regulation better than 2% V_{out} overall

Ripple / Noise < 30 mV_{pp}, (20 MHz bandw., 50 Ω measur.)

Overvolt. protection typ. 35 V

Parallel operation yes, current sharing via soft characteristic (see diagram)

Front panel indicator Green LED

RDY relay contact

- Type normally open contact
- closes when output voltage > 22.1V ±4%
- opens when output voltage < 19.8V ±4%
- Electrical isolation 500V DC to output voltage
- Contact rating 1A at 28V DC

* For further information see data sheets „The SilverLine“, „SilverLine Family Branches“ and mechanics data sheet

Construction / Mechanics*

Housing dimensions and Weight

- W x H x D 120 mm x 124 mm x 102 mm (+ DIN Rail)
- Free space for ventilation above/below 25 mm recommended left/right 15 mm recommended
- Weight 980 g

Design advantages:

- Input and output pluggable by means of Combicon® plug connector
- Ensure strain relief of the plug connectors when installing the unit.



Further information

Further information, especially about

- EMC
 - Connections
 - Safety, Approvals
 - Mechanics and Mounting
- see page 2 of „The SilverLine“ data sheet.

For detailed dimensions

see SilverLine mechanics data sheet SLR2.5/ 5/ 10

Power wiring

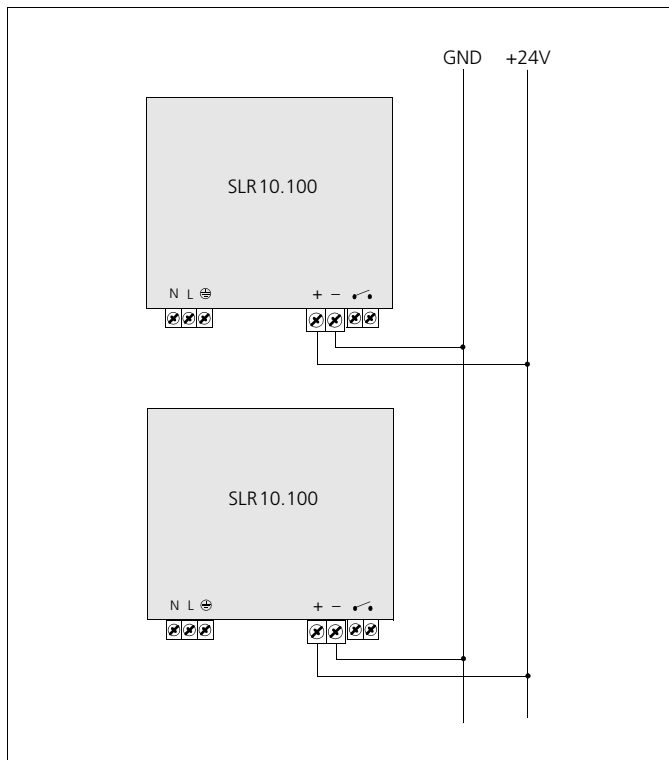

Output characteristic (min.)

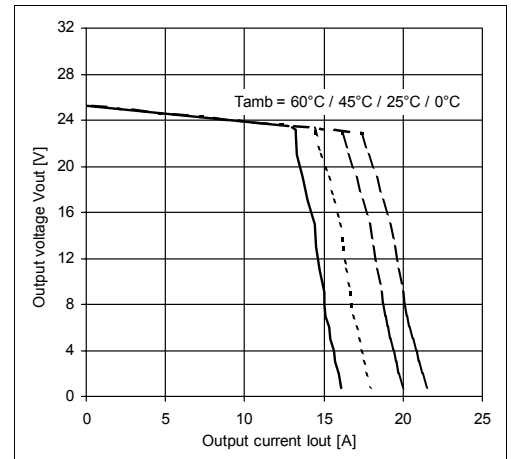

Efficiency (typ.)

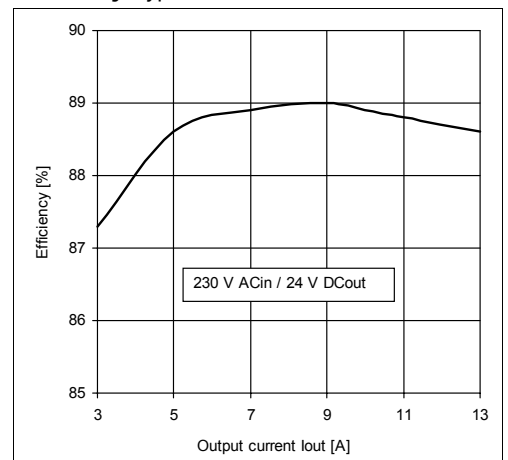

Hold-up time (typ.)

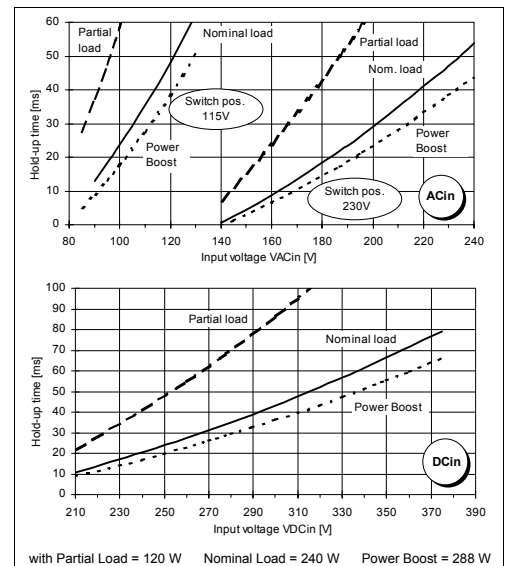

Unless otherwise stated, specifications are valid for AC 230V input voltage, +25°C ambient temperature, and 5 min. run-in time. They are subject to change without prior notice.

Your partner in power supply:



PULS GmbH
 Arabellastraße 15
 D-81925 München
 Tel.: +49 89 9278-0
 Fax: +49 89 9278-199
 www.puls-power.com

SLR2.5 /SLR5 / SLR10

- Innovative DIN-Rail mount, unit holds even at vibration or lateral pressure
- Clearly arranged and user oriented
- Large, robust plug connectors
- Sealed metal housing
- Fine ventilating grid



Data sheet

Side view SLR2.5

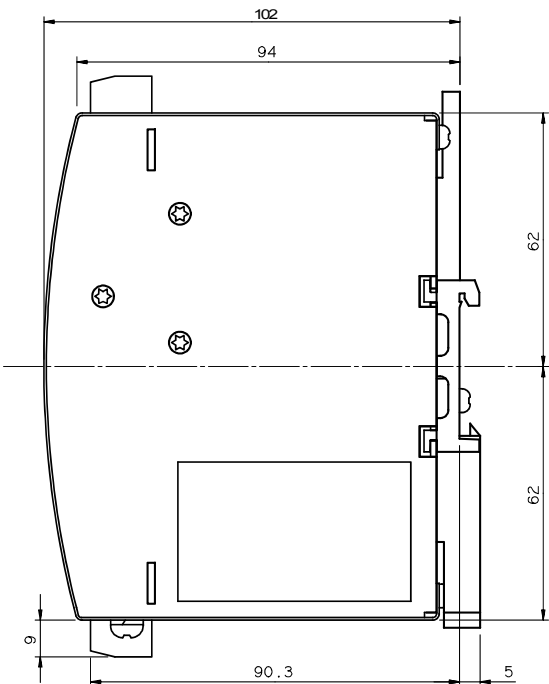

Front view SLR2.5

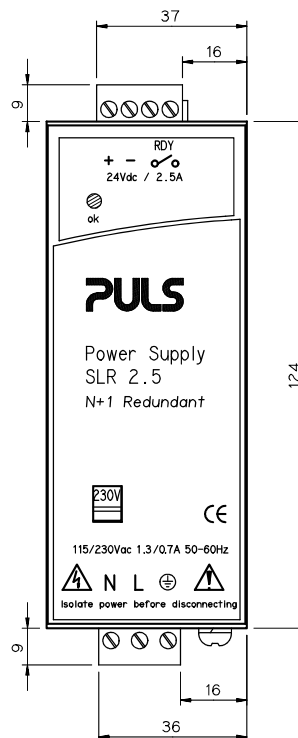

Bottom view SLR2.5

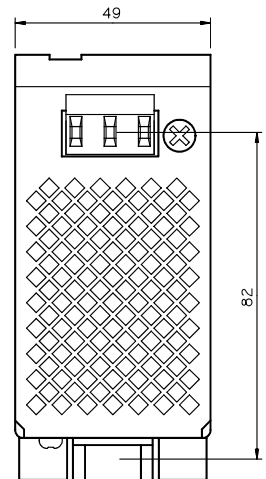

Construction / Mechanics

Unit	Housing dimensions and Weight		Free space for ventilation		
	W x H x D [mm]	weight	left	above/below	right
• SLR2.5	49 x 124 x 102	470 g	0 mm	25 mm each	10 mm
• SLR5.100	64 x 124 x 102	620 g	15 mm	25 mm each	15 mm
• SLR10.10	120 x 124 x 102	980 g	15 mm	25 mm each	15 mm

Overall depth = depth value as mentioned + DIN rail depth

Robust metal housing with fine ventilat. grid (◇ 3,5 mm, IP20), to keep out small parts (e.g. screws)

Mounting	on DIN-Rail (TS35/7.5 or TS35/15, 1...1.5 mm thick), thus
	<ul style="list-style-type: none"> • Simple snap-on system • Sits safely and firmly on the DIN-Rail • No tools required to remove
	or backplane-mounted (two optional screw mounting sets SLZ01 required)

Connections

Connections	stable plug connectors, connector size range: 0.2 – 2.5 mm ²
• Input	0.2 – 2.5 mm ² , SLR10: 0.2 – 4 mm ²
• Output	
• Current handling capacity	12 A each (SLR10: 20 A each)
• Grid	7.62 mm (input) / 5.08 mm (output) distance between adjacent connectors
	SLR10: 7.62 mm (output)
Design advantages:	<ul style="list-style-type: none"> • All connection blocks are easy to reach as mounted at the front panel. • Input and output are strictly apart from each other and so cannot be mixed up

Order information

Order number	Description
SLR2.5: 24V/2.5A	
SLR5.100: 24V/5A	
SLR10.100: 24V/10A	
SLZ01	Screw mounting set, two needed per unit

**Side view and front view
SLR5.100**

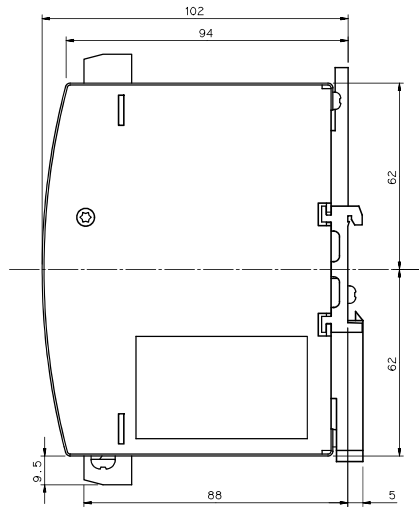
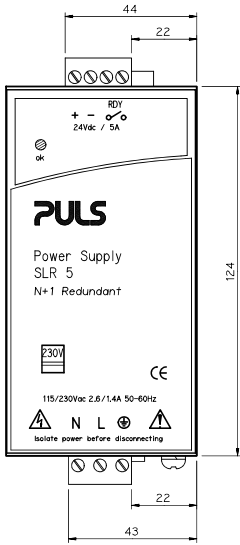

**Bottom view
SLR5.100**

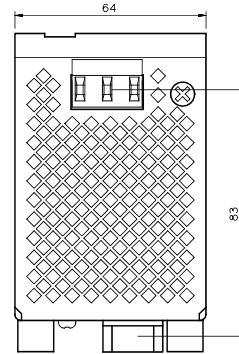

**Side view and front view
SLR10.100**

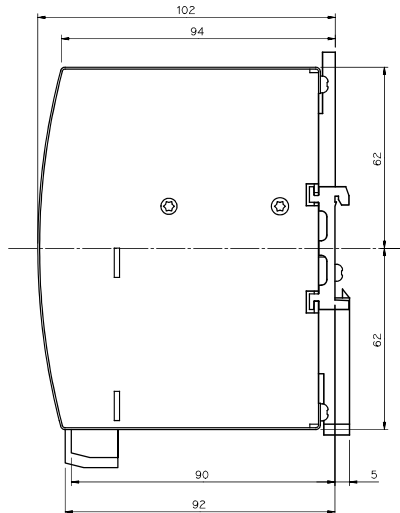
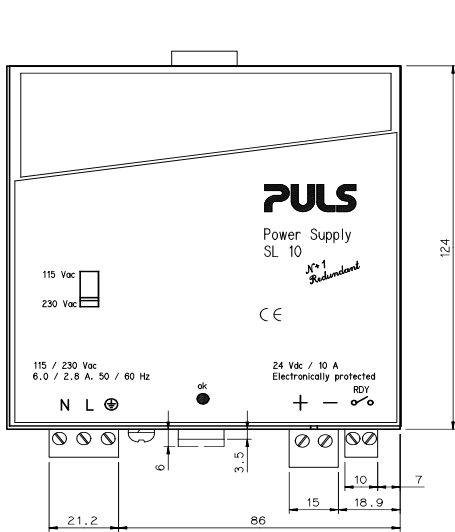

**Bottom view
SLR10.100**

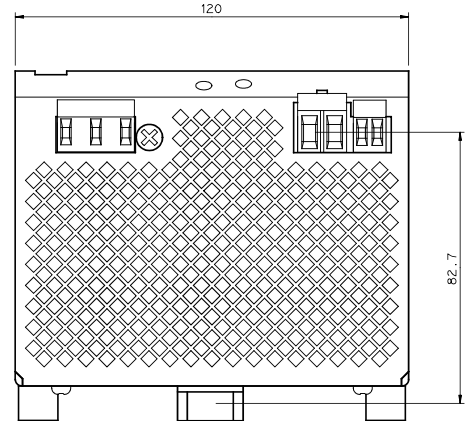

his 'mechanics data sheet' exclusively deals with the mechanical properties of the product. For further information (especially concerning electrical properties), please refer to the generic data sheet of the SLR2.5, SLR5.100 and SLR10.100 and to the basic data sheet „The SilverLine“ dealing with common features of all SilverLine units. This data sheet is subject to change without prior notice.

Your partner in power supply:



PULS GmbH
 Arabellastraße 15
 D-81925 München
 Tel.: +49 89 9278-0
 Fax: +49 89 9278-199
 www.puls-power.com