



## DIN RAIL POWER SUPPLY

- Compact width: Only 79 mm
- Efficiency 97.1 % at 48 V, 20 A
- Power losses at no load: 3.6 W
- Continuous BonusPower: 1152 W (up to +45 °C)
- Dynamic BonusPower management:  
1920 W for up to 15 s  
(up to +40 °C, see Dynamic BonusPower Management)
- Enhanced Hiccup<sup>PLUS</sup> protects connected systems and power supply from overload
- AC OK and DC OK relay contacts
- Active current share bus for constant output voltage in parallel use
- Output voltage adjustable in six steps
- LED bar for visual monitoring the output power
- 3 year warranty

## PRODUCT DESCRIPTION

**PLANET** power supplies are the top-of-the-line industrial grade DIN rail power supplies from PULS. Compact size, high efficiency and dynamic BonusPower capabilities make the **PLANET** power supplies stand out.

Thanks to the integrated **dynamic BonusPower management**, the power supply can adapt to varying power demands in real-time. By continuously monitoring the power output, it can provide extra power for different durations. For example, the power supply can deliver 130 % of its rated power for 22 s or up to 200 % for 5 s at temperatures up to +60 °C. At temperatures up to +45 °C, it can continuously provide 120 % of its rated power.

The high efficiency from stand-by to full load reduces total cost of ownership and carbon dioxide emissions, with particularly low power losses during no-load conditions.

Robust against back-feeding events, **PLANET** power supplies minimise downtime and ensure safety and reliability with Hiccup<sup>PLUS</sup> mode in case of overload.

The **PLANET TP** series combines these features in highly reliable and elegantly designed DIN rail power supplies. The **TP960.481** model is equipped with quick connector push-in terminals which can be used for all types of wires and enable quick installation.

The LED bar directly displays the power load of connected equipment.

The DC OK and AC OK relay contacts enable remote diagnostics.

## ORDER NUMBERS

**TP960.481** Power Supply

**Complementary units:**

ZM10.WALL Wall / panel mount bracket

## SHORT-FORM DATA

|                   |                                |                              |
|-------------------|--------------------------------|------------------------------|
| Output voltage    | DC 48 V                        | nominal                      |
| Adjustment range  | 48 - 56 Vdc                    | six step adjustable settings |
| Output current    | 24 - 20.6 A                    | up to +45 °C                 |
|                   | 20 - 17.1 A                    | up to +60 °C                 |
|                   | 16.8 - 14.4 A                  | at +70 °C                    |
| short term (15 s) | 40 A                           | up to +40 °C                 |
| Derating          | linearly 12.8 W/K              | +45 °C to +60 °C             |
|                   | linearly 15 W/K                | +60 °C to +70 °C             |
| Input voltage AC  | 3AC 380 - 500 V                | -15 / +10 %                  |
| Input current AC  | 1.53 / 1.23 A                  | at 3x 400 / 500 Vac          |
| Power factor      | 0.93 / 0.93                    | at 3x 400 / 500 Vac          |
| Inrush current AC | no inrush current peak         |                              |
| Efficiency        | 97.2 / 97.1 %                  | at 3x 400 / 500 Vac          |
| Power losses      | 27 / 28 W                      | at 3x 400 / 500 Vac          |
| Hold-up time      | 29 / 29 ms                     | at 3x 400 / 500 Vac          |
| Temperature range | -40 °C to +70 °C               |                              |
| Size (w x h x d)  | 79x124x136 mm without DIN rail |                              |
| Weight            | 1100 g                         |                              |

## MAIN APPROVALS

For details and the complete approval list, see chapter 25



**SEMI F47**

UL 61010-2-201

SEMI F47

All parameters are specified at 48 V, 20 A, 3x 400 Vac, +25 °C ambient and after a 5 minutes run-in time unless otherwise noted.

## Index

|    |                                   |    |      |   |    |
|----|-----------------------------------|----|------|---|----|
| 1  | Intended Use.....                 | 3  | 20   | EMC.....  | 20 |
| 2  | Installation Instructions.....    | 3  | 21   | Environment.....                                  | 21 |
| 3  | AC Input.....                     | 4  | 22   | Protection Features.....                          | 22 |
| 4  | External Input Protection.....    | 5  | 23   | Safety Features.....                              | 22 |
| 5  | DC Input.....                     | 5  | 24   | Dielectric Strength.....                          | 23 |
| 6  | Input Inrush Current.....         | 5  | 25   | Approved, Fulfilled or Tested Standards.....      | 24 |
| 7  | Output.....                       | 6  | 26   | Regulatory Product Compliance.....                | 24 |
| 8  | Hold-up Time.....                 | 11 | 27   | Physical Dimensions and Weight.....               | 25 |
| 9  | DC OK Relay Contact.....          | 11 | 28   | Accessories.....                                  | 26 |
| 10 | AC OK Relay Contact.....          | 12 | 28.1 | ZM10.Wall - Wall / Panel Mounting<br>Bracket..... | 26 |
| 11 | Current Share Bus.....            | 13 | 29   | Application Notes.....                            | 27 |
| 12 | Internal Data Logging.....        | 13 | 29.1 | Using Only 2 Legs of a 3-Phase System.....        | 27 |
| 13 | Efficiency and Power Losses.....  | 14 | 29.2 | Output Circuit Breakers.....                      | 28 |
| 14 | Lifetime Expectancy.....          | 15 | 29.3 | Parallel Use for Redundancy.....                  | 28 |
| 15 | MTBF.....                         | 15 | 29.4 | Series Operation.....                             | 29 |
| 16 | Functional Diagram.....           | 16 | 29.5 | Mounting Orientations.....                        | 29 |
| 17 | Terminals and Wiring.....         | 17 |      |   |    |
| 18 | Front Side and User Elements..... | 19 |      |   |    |
| 19 | Status LED Signaling.....         | 19 |      |   |    |

The information given in this document is correct to the best of our knowledge and experience at the time of publication. If not expressly agreed otherwise, this information does not represent a warranty in the legal sense of the word. As the state of our knowledge and experience is constantly changing, the information in this data sheet is subject to revision. We therefore kindly ask you to always use the latest issue of this document (available under [www.pulspower.com](http://www.pulspower.com)).

No part of this document may be reproduced or utilised in any form without our prior permission in writing.

Packaging and packaging aids can and should always be recycled. The product itself may not be disposed of as domestic refuse.

## Terminology and Abbreviation

|  |   |
|--|---|
| <b>PE and <math>\oplus</math> Symbol</b> | PE is the abbreviation for <b>Protective Earth</b> and has the same meaning as the symbol $\oplus$ .  |
| <b>Earth, Ground</b>                     | This document uses the term "earth" which is the same as the U.S. term "ground".  |
| <b>t.b.d.</b>                            | To be defined, value or description will follow later.  |
| <b>3AC 500 V</b>                         | A figure displayed with the AC or DC before the value represents a nominal voltage with standard tolerances (usually $\pm 15\%$ ) included.<br>E.g.: DC 12 V describes a 12 V battery disregarding whether it is full (13.7 V) or flat (10 V) |
| <b>3x 500 Vac</b>                        | A figure with the unit (Vac) at the end is a momentary figure without any additional tolerances included.   |
| <b>50 Hz vs. 60 Hz</b>                   | As long as not otherwise stated, AC 380 V and AC 500 V parameters are valid at 50 Hz mains frequency. AC 500 V parameters are valid for 60 Hz mains frequency.  |
| <b>may</b>                               | A key word indicating flexibility of choice with no implied preference.   |
| <b>shall</b>                             | A key word indicating a mandatory requirement.  |
| <b>should</b>                            | A key word indicating flexibility of choice with a strongly preferred implementation.   |

## 1. Intended Use

This device is designed for installation in an enclosure and is intended for commercial use, such as in industrial control, process control, monitoring and measurement equipment or the like.

Do not use this device in equipment where malfunction may cause severe personal injury or threaten human life.

If this device is used in a manner outside of its specification, the protection provided by the device may be impaired.

## 2. Installation Instructions

**⚠ DANGER** Risk of electrical shock, fire, personal injury or death.

- Turn power off before working on the device. Protect against inadvertent re-powering.
- Do not open, modify or repair the device.
- Use caution to prevent any foreign objects from entering the housing.
- Do not use in wet locations or in areas where moisture or condensation can be expected.
- Do not touch during power-on, and immediately after power-off. Hot surfaces may cause burns.

### Obey the following installation instructions:

This device may only be installed and put into operation by qualified personnel. This device does not contain serviceable parts. The tripping of an internal fuse is caused by an internal defect. If damage or malfunction should occur during installation or operation, immediately turn power off and send unit to the factory for inspection.

Install device in an enclosure providing protection against electrical, mechanical and fire hazards.

The device is designed, tested and approved for branch circuits up to 32 A (IEC) and 30 A (UL) without additional protection device. If an external fuse is utilized, do not use circuit breakers smaller than 6 A B- or C-Characteristic to avoid a nuisance tripping of the circuit breaker.

Install the device onto a DIN rail according to EN 60715 with the input terminals on the bottom of the device. Other mounting orientations require a reduction in output current.

Make sure that the wiring is correct by following all local and national codes. Use appropriate copper cables that are designed for the maximum operating temperature in the application. Ensure that all strands of a stranded wire enter the terminal connection. Use ferrules for wires on the input terminals. The device is designed for pollution degree 2 areas in controlled environments. No condensation or frost is allowed.

The enclosure of the device provides a degree of protection of IP20. The enclosure does not provide protection against spilled liquids.

For TN, TT mains systems with earthed neutral and IT star mains systems with insulation monitoring the device is designed for overvoltage category III zones up to 2000 m and for overvoltage category II zones up to 5000 m. For TN, TT, IT delta mains systems or IT star mains systems without insulation monitoring the device is intended for overvoltage category II zones up to 2000 m.

The device is designed for convection cooling and does not require an external fan. Do not obstruct airflow and do not cover ventilation grid!

The device is designed for altitudes up to 5000 m. Above 2000 m a reduction in output current of 1.25 A per 1000 m is required and the operation is limited according the mains systems description above.

Keep the following minimum installation clearances: 30 mm on bottom, 40 mm on top, 5 mm left and right side. Increase the 5 mm to 15 mm in case the adjacent device is a heat source. When the device is permanently loaded with less than 50 %, the 5 mm can be reduced to zero.

The maximum surrounding air temperature is +70 °C. The operational temperature is the same as the ambient or surrounding air temperature and is defined 3 cm below the device.

The device is designed to operate in areas between 5 % and 95 % relative humidity.

### 3. AC Input

The device is suitable to be supplied from TN-, TT-, IT- or corner grounded delta mains networks with AC voltage.

|                           |                                  |                 |   |
|---------------------------|----------------------------------|-----------------|---|
| AC input                  | nom.                             | 3AC 380-500 Vac |   |
| AC input range            |                                  | 3x 323-550 Vac  |   |
| Input to PE               | max.                             | 550 Vac         | according to IEC 60664-1                      |
| Input frequency           | nom.                             | 50-60 Hz        | ± 6 %   |
| Turn-on voltage           | typ.                             | 3x 305 Vac      | steady-state value, see Fig. 3-1              |
| Shut-down voltage         | typ.                             | 3x 275 Vac      | steady-state value at 20 A load, see Fig. 3-1 |
| External input protection | see recommendations in chapter 4 |                 |   |

|                            |      | 3AC 400 V | 3AC 500 V |  |
|----------------------------|------|-----------|-----------|--|
| Input current              | typ. | 1.53 A    | 1.23 A    | at 48 V, 20 A, see Fig. 3-3  |
| Power factor <sup>1)</sup> | typ. | 0.93      | 0.93      | at 48 V, 20 A, see Fig. 3-4  |
| Start-up delay             | typ. | 1200 ms   | 1200 ms   | see Fig. 3-2   |
| Rise time                  | typ. | 20 ms     | 20 ms     | at 48 V, 20 A const. current load, 0 mF load capacitance, see Fig. 3-2   |
|                            | typ. | 130 ms    | 130 ms    | at 48 V, 20 A const. current load, 110 mF load capacitance, see Fig. 3-2 |
| Turn-on overshoot          | max. | 500 mV    | 500 mV    | see Fig. 3-2   |

1) The power factor is the ratio of the true (or real) power to the apparent power in an AC circuit.

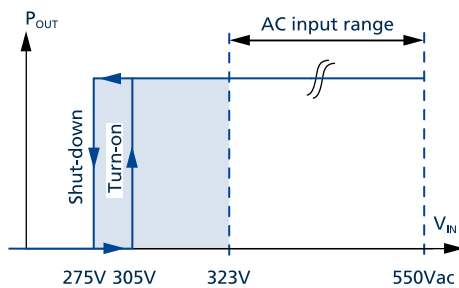

Fig. 3-1: Input voltage range

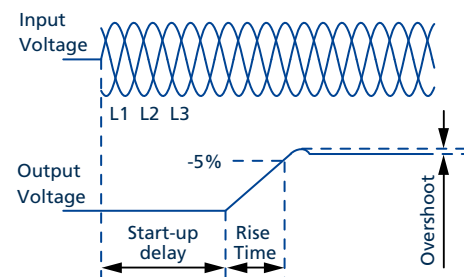

Fig. 3-2: Turn-on behavior, definitions

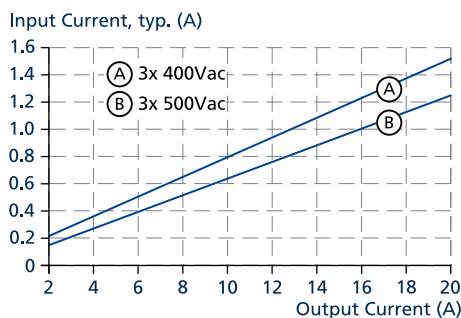

Fig. 3-3: Input current vs. output current at 48 V output voltage

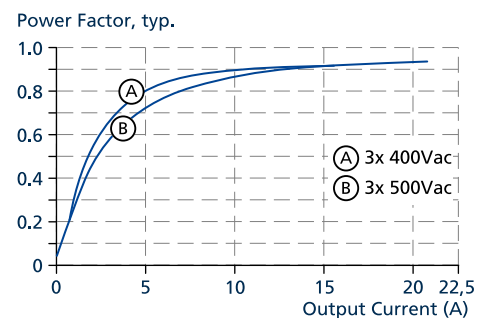

Fig. 3-4: Power factor vs. output current at 48 V output voltage

## 4. External Input Protection

The unit is tested and approved for branch circuits up to 30 A (U.S.A.) and 32 A (IEC). An external protection is only required if the supplying branch has an ampacity greater than this. Check also local codes and local requirements. In some countries local regulations might apply.

If an external fuse is necessary or utilized, minimum requirements need to be considered to avoid nuisance tripping of the circuit breaker. A minimum value of 6 A B- or C-Characteristic breaker should be chosen.

## 5. DC Input

Do not operate this power supply with DC input voltage.

## 6. Input Inrush Current

The power supply is equipped with an active inrush current limitation circuit, which limits the input inrush current after turn-on to a negligible low value. The input current is usually smaller than the steady-state input current, see Fig. 6-1: Typical turn-on behaviour at nominal load and +25 °C ambient<sup>1</sup>.

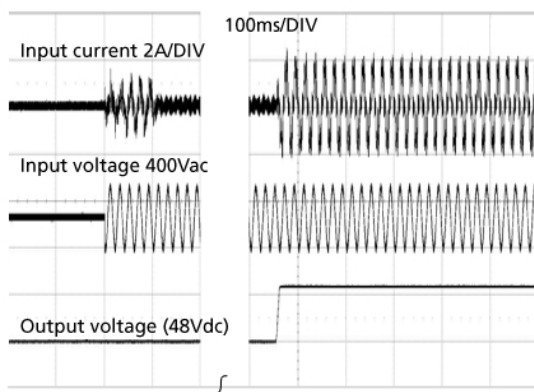

Fig. 6-1: Typical turn-on behaviour at nominal load and +25 °C ambient<sup>1</sup>

<sup>1</sup> The input current is usually smaller than the steady-state input current.

## 7. Output

|                                     |   |              |   |
|-------------------------------------|---|--------------|---|
| Output voltage                      | nom.                                      | 48 Vdc       |   |
| Adjustment range                    |   | 48-56 V      | detent potentiometer with 6 settings<br>48 V, 50 V, 52 V, 54 V, 55 V, 56 V  |
| Factory settings                    | max.                                      | 56 V         |   |
|                                     | typ.                                      | 48 V         | ± 0.2 % using current share bus   |
| Line regulation                     | max.                                      | 10 mV        | between 3x 323 Vac and 550 Vac  |
| Load regulation                     | max.                                      | 100 mV       | between 0 A and 24 A, static value, see Fig. 7-1  |
| Ripple and noise voltage            | max.                                      | 56 mVpp      | at 20 Hz to 20 MHz, 50 Ohm  |
| Output current                      | nom.                                      | 20 A         | at 48 V and up to +60 °C ambient temperature  |
|                                     | nom.                                      | 16.8 A       | at 48 V and up to +70 °C ambient temperature  |
|                                     | nom.                                      | 17.1 A       | at 56 V and up to +60 °C ambient temperature  |
|                                     | nom.                                      | 14.4 A       | at 56 V and up to +70 °C ambient temperature  |
|                                     |   |              | Derate linearly between +60 °C and +70 °C, see Fig. 21-1  |
| BonusPower continuous <sup>1)</sup> | nom.                                      | 24 A         | at 48 V and up to +45 °C ambient temperature  |
|                                     | nom.                                      | 20.6 A       | at 56 V and up to +45 °C ambient temperature  |
|                                     |   |              | BonusPower continuous decreases linearly to nominal power between +45 °C and +60 °C, see Fig. 21-1  |
| Output power                        | nom.                                      | 960 W        | continuously available  |
| BonusPower continuous <sup>1)</sup> |   | 1152 W       | at 48 V, up to +45 °C   |
| BonusPower short term <sup>2)</sup> |   | 1920 W       | at 48 V, up to +40 °C for 15 s or +60 °C for 6.8 s  |
| Fuse breaking current               | typ.                                      | 100 A        | Up to 12 ms once every 5 s, see Fig. 7-2. The fuse breaking current is an enhanced transient current which helps to trip fuses on faulty output branches. The output voltage stays above 40 V.  |
| Overload behaviour                  | Continuous current                        |              | for output voltage above 20 Vdc   |
|                                     | Hiccup <sup>PLUS</sup> mode <sup>3)</sup> |              | for output voltage below 20 Vdc   |
| Overload / short-circuit current    |   | 40 A         | Discharge current of output capacitors is not included.   |
| Output capacitance                  | nom.                                      | 6 220 µF     | included inside the power supply  |
| Back-feeding loads                  | max.                                      | 60 V / 3.5 J | The unit is resistant and does not show malfunctioning when a load feeds back voltage to the power supply. It does not matter whether the power supply is on or off. The absorbing energy can be calculated according to the built-in large sized output capacitor. |

- 1) BonusPower continuous:**  
This power / current is continuously allowed up to an ambient temperature of +45 °C. Above +45 °C, do not use this power or current longer than a duty cycle of 10 % and / or not longer than 1 minute every 10 minutes.
- 2) BonusPower short term:**  
The power supply is designed to support loads with a higher short-term power requirement without damage or shutdown. The short-term duration is hardware controlled by an output power manager. This power is repeatedly available.
- 3) Hiccup<sup>PLUS</sup> mode:**  
At heavy overloads (when output voltage falls below 20 V), the power supply delivers continuous output current for 2 s. After this, the output is switched off for approx. 8 s before a new start attempt is automatically performed. This cycle is repeated as long as the overload exists. If the overload has been cleared, the device will operate normally, see Fig. 7-3.

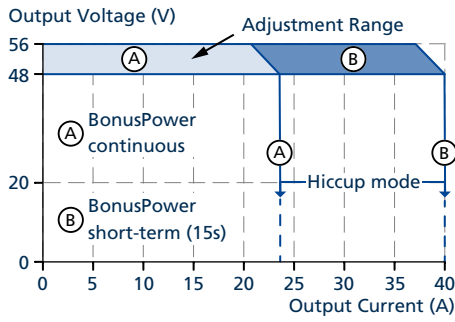

Fig. 7-1: Output voltage vs. output current, typ.

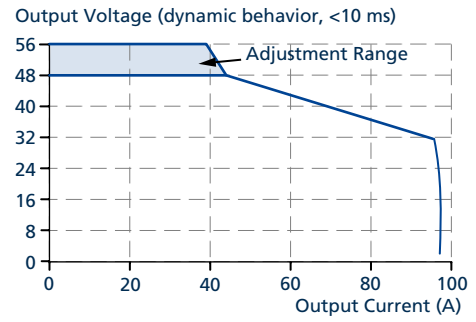

Fig. 7-2: Dynamic overcurrent capability, typ.

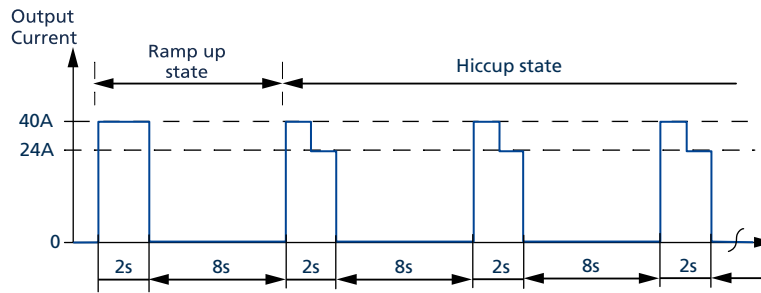

Fig. 7-3: Short-circuit on output, Hiccup<sup>PLUS</sup> mode, typ.

### Dynamic BonusPower Management

The power supply continuously monitors the power output through a power-time-integral. Therefore, BonusPower may be available longer than the maximum specified time if less BonusPower is utilised than the maximum allowed. Calculations assume the temperature stays at or up to +45 °C with a base load of 120 % or +60 °C with a base load with 100 %, depending on the threshold.

| BonusPower utilised | Time BonusPower is available (s) up to +45 °C | Time BonusPower is available (s) up to +60 °C |
|---------------------|---|---|
| 110 %               | continuous                                    | 172.5   |
| 120 %               | continuous                                    | 143.0   |
| 130 %               | 153.6   | 128.4   |
| 140 %               | 73.8  | 60.6  |
| 150 %               | <b>47.4</b>                                   | <b>40.1</b>                                   |
| 160 %               | 34.2  | 31.1  |
| 170 %               | 26.4  | 17.1  |
| 180 %               | 21.3  | 12.2  |
| 190 %               | 17.7  | 9.1   |
| 200 %               | 12.0  | 6.8   |

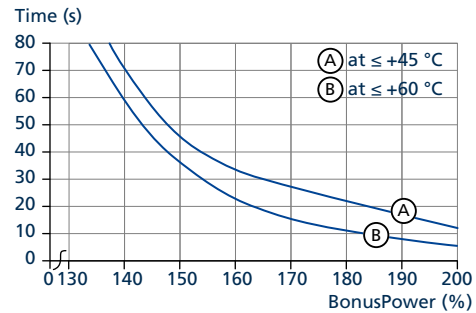

Fig. 7-4: Calculated time availability of BonusPower

**i** After operating at BonusPower, the power supply needs a cool-down period or recovery time. This can be calculated depending on the **base load below 100 %** following the BonusPower period.

$$t_{\text{recover}} = \frac{P_{\text{BonusPower used}}^2 - P_{\text{nominal power}}^2}{P_{\text{nominal power}}^2 - P_{\text{base load}}^2} \times t_{\text{BonusPower used}}$$

**Example:**

Examples of recovery time after maximum BonusPower of **150 %** with various durations are displayed in the following table:

| Base load<br>% from Pnom | BonusPower time (s)<br>up to +45 °C |     |      |      |                   | BonusPower time (s)<br>up to +60 °C |      |      |      |                   | Recovery time (s) |
|--------------------------|-------------------------------------|-----|------|------|-------------------|-------------------------------------|------|------|------|-------------------|-------------------|
|                          | 1 s                                 | 5 s | 10 s | 15 s | ... <sup>4)</sup> | 1 s                                 | 5 s  | 10 s | 15 s | ... <sup>4)</sup> |                   |
| 0 %                      | 0.6                                 | 2.8 | 5.6  | 8.4  |                   | 1.3                                 | 6.3  | 12.5 | 18.8 |                   |                   |
| 10 %                     | 0.6                                 | 2.8 | 5.7  | 8.5  |                   | 1.3                                 | 6.3  | 12.6 | 18.9 |                   |                   |
| 20 %                     | 0.7                                 | 2.9 | 5.8  | 8.7  |                   | 1.3                                 | 6.5  | 13.0 | 19.5 |                   |                   |
| 30 %                     | 0.6                                 | 3.0 | 6.0  | 9.0  |                   | 1.4                                 | 6.9  | 13.7 | 20.6 |                   |                   |
| 40 %                     | 0.6                                 | 3.2 | 6.3  | 9.5  |                   | 1.5                                 | 7.4  | 14.9 | 22.3 |                   |                   |
| 50 %                     | 0.7                                 | 3.4 | 6.8  | 10.2 |                   | 1.7                                 | 8.3  | 16.7 | 25.0 |                   |                   |
| 60 %                     | 0.8                                 | 3.8 | 7.5  | 11.3 |                   | 2.0                                 | 9.8  | 19.6 | 29.3 |                   |                   |
| 70 %                     | 0.9                                 | 4.3 | 8.5  | 12.8 |                   | 2.5                                 | 12.3 | 24.5 | 36.7 |                   |                   |
| 80 %                     | 1.0                                 | 5.1 | 10.1 | 15.2 |                   | 3.5                                 | 17.4 | 34.7 | 52.1 |                   |                   |
| 90 %                     | 1.3                                 | 6.4 | 12.9 | 19.3 |                   | 6.6                                 | 32.9 | 65.8 | 98.7 |                   |                   |

4) The seconds can be specified with any value. 1 / 5 / 10 / 15 s are given as examples.

**Sample calculation**

|                         |               |               |
|-------------------------|---------------|---------------|
| BonusPower used         | 150 %         | 1440 W        |
| Nominal Power at +60 °C | 100 %         | 960 W         |
| Base Load               | 90 %          | 864 W         |
| Time Bonus Power used   | <b>40.1 s</b> | <b>40.1 s</b> |

$$t_{\text{recover}} = \frac{(1440 \text{ W})^2 - (960 \text{ W})^2}{(960 \text{ W})^2 - (864 \text{ W})^2} \times 40.1 \text{ s}$$

$$t_{\text{recover}} = 263.8 \text{ s}$$

|                         |               |               |
|-------------------------|---------------|---------------|
| BonusPower used         | 150 %         | 1440 W        |
| Nominal Power at +45 °C | 120 %         | 1152 W        |
| Base Load               | 90 %          | 864 W         |
| Time Bonus Power used   | <b>47.4 s</b> | <b>47.4 s</b> |

$$t_{\text{recover}} = \frac{(1440 \text{ W})^2 - (1152 \text{ W})^2}{(1152 \text{ W})^2 - (864 \text{ W})^2} \times 47.4 \text{ s}$$

$$t_{\text{recover}} = 60.9 \text{ s}$$

Examples of recovery time after maximum BonusPower of 200 % with various durations are displayed in the following table:

| Base load<br>% from Pnom | BonusPower time (s)<br>up to +45 °C |       |       |              |                   | BonusPower time (s)<br>up to +60 °C |       |             |       |                   | Recovery time (s) |
|--------------------------|-------------------------------------|-------|-------|--------------|-------------------|-------------------------------------|-------|-------------|-------|-------------------|-------------------|
|                          | 1 s                                 | 5 s   | 10 s  | 15 s         | ... <sup>4)</sup> | 1 s                                 | 5 s   | 10 s        | 15 s  | ... <sup>4)</sup> |                   |
| 0 %                      | 1.8                                 | 8.9   | 17.8  | 26.7         |                   | 3.0                                 | 15.0  | 30.0        | 45.0  |                   |                   |
| 10 %                     | 1.8                                 | 9.0   | 17.9  | 26.9         |                   | 3.0                                 | 15.2  | 30.3        | 45.5  |                   |                   |
| 20 %                     | 1.8                                 | 9.1   | 18.3  | 27.4         |                   | 3.1                                 | 15.6  | 31.3        | 46.9  |                   |                   |
| 30 %                     | 1.9                                 | 9.5   | 19.0  | 28.4         |                   | 3.3                                 | 16.5  | 33.0        | 49.5  |                   |                   |
| 40 %                     | 2.0                                 | 10.0  | 20.0  | 30.0         |                   | 3.6                                 | 17.9  | 35.7        | 53.6  |                   |                   |
| 50 %                     | 2.2                                 | 10.8  | 21.5  | 32.3         |                   | 4.0                                 | 20.0  | 40.0        | 60.0  |                   |                   |
| 60 %                     | 2.4                                 | 11.9  | 23.7  | 35.6         |                   | 4.7                                 | 23.4  | 46.9        | 70.3  |                   |                   |
| 70 %                     | 2.7                                 | 13.5  | 27.0  | 40.4         |                   | 5.9                                 | 29.4  | 58.8        | 88.2  |                   |                   |
| 80 %                     | 3.2                                 | 16.0  | 32.0  | 48.0         |                   | 8.3                                 | 41.7  | <b>83.3</b> | 125.0 |                   |                   |
| 90 %                     | 4.1                                 | 20.3  | 40.6  | 61.0         |                   | 15.8                                | 79.0  | 157.9       | 236.8 |                   |                   |
| 100 % <sup>5)</sup>      | 5.8                                 | 29.1  | 58.2  | 87.3         |                   | 75.8                                | 378.8 | x           | x     |                   |                   |
| 110 % <sup>5)</sup>      | 11.1                                | 55.7  | 111.3 | <b>167.0</b> |                   | x                                   | x     | x           | x     |                   |                   |
| 120 % <sup>5)</sup>      | 53.8                                | 268.9 | 537.8 | x            |                   | x                                   | x     | x           | x     |                   |                   |

5) Values exceeding 100 % are empirical and not directly calculable.

### Sample calculation

|                         |       |        |
|-------------------------|-------|--------|
| BonusPower used         | 200 % | 1920 W |
| Nominal Power at +60 °C | 100 % | 960 W  |
| Base Load               | 80 %  | 768 W  |
| Time Bonus Power used   | 10 s  | 10 s   |

$$t_{\text{recover}} = \frac{(1920 \text{ W})^2 - (960 \text{ W})^2}{(960 \text{ W})^2 - (768 \text{ W})^2} \times 10 \text{ s}$$

$$t_{\text{recover}} = 83.3 \text{ s}$$

|                         |       |        |
|-------------------------|-------|--------|
| BonusPower used         | 200 % | 1920 W |
| Nominal Power at +45 °C | 120 % | 1152 W |
| Base Load               | 110 % | 1056 W |
| Time Bonus Power used   | 15 s  | 15 s   |

$$t_{\text{recover}} = \frac{(1920 \text{ W})^2 - (1152 \text{ W})^2}{(1152 \text{ W})^2 - (1056 \text{ W})^2} \times 15 \text{ s}$$

$$t_{\text{recover}} = 167.0 \text{ s}$$

## 8. Hold-up Time

The hold-up time is the time during which a power supply's output voltage remains within specification following the loss of input power. The hold-up time is output load dependent. At no load, the hold-up time can be up to several seconds. The green DC OK LED is also on during the hold-up time.

|              |      | 3AC 400 V | 3AC 500 V |                             |
|--------------|------|-----------|-----------|-----------------------------|
| Hold-up time | typ. | 55 ms     | 55 ms     | at 48 V, 10 A, see Fig. 8-1 |
|              | min. | 48 ms     | 48 ms     | at 48 V, 10 A, see Fig. 8-1 |
|              | typ. | 29 ms     | 29 ms     | at 48 V, 20 A, see Fig. 8-1 |
|              | min. | 20 ms     | 20 ms     | at 48 V, 20 A, see Fig. 8-1 |

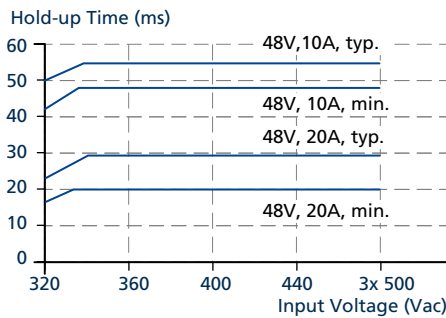

Fig. 8-1: Hold-up time vs. input voltage

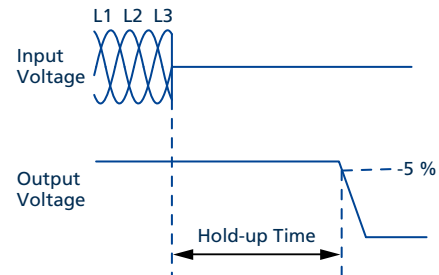

Fig. 8-2: Shut-down behaviour

## 9. DC OK Relay Contact

This feature monitors the output voltage, which is produced by the power supply itself. It is independent of a back-fed voltage from a unit connected in parallel to the power supply output.

|                      |  |
|----------------------|--|
| Contact closes       | As soon as the output voltage reaches typ. 90 % of the adjusted output voltage level.  |
| Contact opens        | As soon as the output voltage dips more than 10 % below the adjusted output voltage. Short dips will be extended to a signal length of 100 ms. Dips shorter than 1 ms will be ignored. |
| Switching hysteresis | typ. 2 V   |
| Contact ratings      | maximum 60 Vdc 0.3 A, resistive load<br>minimum permissible load: 1 mA at 5 Vdc  |
| Isolation voltage    | see chapter 24, dielectric strength table  |

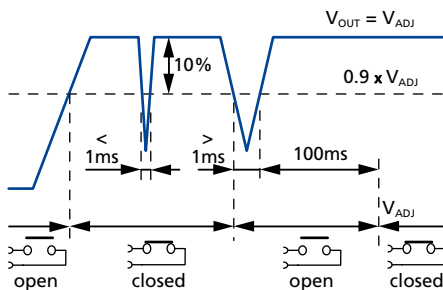

Fig. 9-1: DC OK relay contact behaviour



## 11. Current Share Bus

---

The current share bus distributes the current evenly for power supplies operating in parallel. It functions as an active current-sharing system, providing the advantage of maintaining a constant output voltage, regardless of the connected load.

To enable parallel operation, the bus-pins of each unit (pin 4.5 and 4.6) need to be daisy-chained, with the power return pins serving as the return path for the signal. This feature is especially beneficial for maintaining stable and consistent power output in parallel power supply configurations.

Make sure to adjust the output voltage potentiometer to the same values.

For detailed wiring, see chapter 17.

## 12. Internal Data Logging

---

A microcontroller inside the power supply acquires and stores operating data during the lifetime of the unit. The data can be retrieved by the PULS service and repair personnel, even when the unit is defect. The data allows better troubleshooting in case of failure.

### Acquired data:

- Name of product series (TP960), revision of firmware
- Device configuration (such as output voltage setpoint, calibration data, etc.)
- Operational data:
  - Operating hours and remaining portion of lifetime
  - Maximum and minimum temperatures of semiconductors, capacitors and microcontrollers (values and counters)
  - Overtemperature event (counter)
  - Output voltage (min, max, value)
  - Output current (min, max, value)
  - Input voltage (rms min and max, value)
  - Input voltage (peak, max value)
  - Input voltage asymmetry (rms max, value and counter)
  - Input overvoltage events (individual line-to-line rms and transient, counters)
  - Input undervoltage sags (counter)
  - Input voltage line-to-line phase fail (counters)
- Number of turn-on sequences

### 13. Efficiency and Power Losses

|                                  |      | 3AC 400 V | 3AC 500 V |  |
|----------------------------------|------|-----------|-----------|--|
| Efficiency                       | typ. | 97.2 %    | 97.1 %    | at 48 V, 20 A  |
|                                  | typ. | 97 %      | 96.9 %    | at 48 V, 24 A (BonusPower continuous)                    |
| Average efficiency <sup>1)</sup> | typ. | 97.1 %    | 96.8 %    | 25 % at 5 A, 25 % at 10 A,<br>25 % at 15 A, 25 % at 20 A |
| Power losses                     | typ. | 3.6 W     | 3.7 W     | at 48 V, 0 A   |
|                                  | typ. | 13 W      | 14 W      | at 48 V, 10 A  |
|                                  | typ. | 27 W      | 28 W      | at 48 V, 20 A  |
|                                  | typ. | 36 W      | 37 W      | at 48 V, 24 A (BonusPower continuous)                    |

<sup>1)</sup> The average efficiency is an assumption for a typical application where the power supply is loaded with 25 % of the nominal load for 25 % of the time, 50 % of the nominal load for another 25 % of the time, 75 % of the nominal load for another 25 % of the time and with 100 % of the nominal load for the rest of the time.

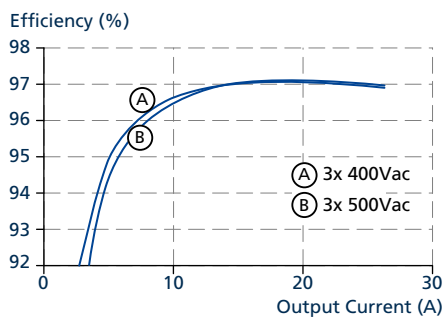

Fig. 13-1: Efficiency vs. output current at 48 V, typ.

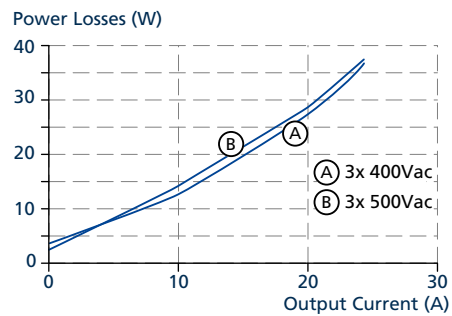

Fig. 13-2: Losses vs. output current at 48 V, typ.

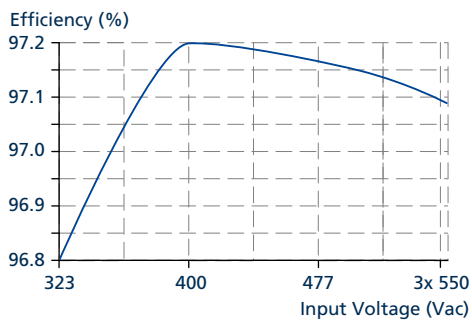

Fig. 13-3: Efficiency vs. input voltage at 48 V, 20 A, typ.

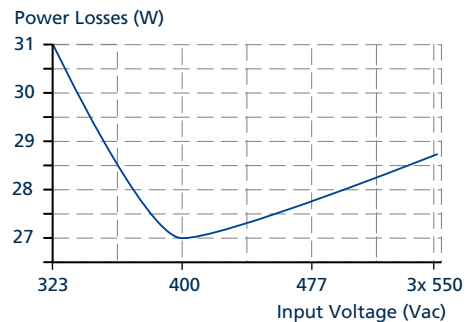

Fig. 13-4: Losses vs. input voltage at 48 V, 20 A, typ.

## 14. Lifetime Expectancy

The lifetime expectancy shown in the table indicates the minimum operating hours (service lifetime) and is determined by the lifetime expectancy of the built-in electrolytic capacitors. Lifetime expectancy is specified in operational hours and is calculated according to the capacitor's manufacturer specification. The manufacturer of the electrolytic capacitors only guarantees a maximum life of up to 15 years (131 400 h). Any number exceeding this value is a calculated theoretical lifetime, which can be used to compare devices.

|                     | 3AC 400 V   | 3AC 500 V   |                          |
|---------------------|-------------|-------------|--------------------------|
| Lifetime expectancy | 421 752 h   | 421 752 h   | at 48 V, 10 A and +40 °C |
|                     | 1 209 548 h | 1 209 548 h | at 48 V, 10 A and +25 °C |
|                     | 118 127 h   | 118 127 h   | at 48 V, 20 A and +40 °C |
|                     | 443 932 h   | 443 932 h   | at 48 V, 20 A and +25 °C |
|                     | 66 208 h    | 66 208 h    | at 48 V, 24 A and +40 °C |
|                     | 218 914 h   | 218 914 h   | at 48 V, 24 A and +25 °C |

## 15. MTBF

MTBF stands for **Mean Time Between Failures**, which is calculated according to statistical device failures, and indicates reliability of a device. It is the statistical representation of the likelihood of a unit to fail and does not necessarily represent the lifetime of a product.

An MTBF figure of e.g. 1 000 000 h means that statistically one unit out of 10 000 installed units will fail every 100 h. However, it can not be determined if the failed unit has been running for 50 000 h or only for 100 h.

For these types of units the MTTF (**Mean Time To Failures**) value is the same value as the MTBF value.

|                          | 3AC 400 V | 3AC 500 V |  |
|--------------------------|-----------|-----------|--|
| MTBF SN 29500, IEC 61709 | 342 000 h | 325 000 h | at 48 V, 20 A and +40 °C                     |
|                          | 753 000 h | 721 000 h | at 48 V, 20 A and +25 °C                     |
| MTBF MIL HDBK 217F       | 209 000 h | 202 000 h | at 48 V, 20 A and +40 °C; Ground Benign GB40 |
|                          | 284 000 h | 271 000 h | at 48 V, 20 A and +25 °C; Ground Benign GB25 |
|                          | 45 000 h  | 43 000 h  | at 48 V, 20 A and +40 °C; Ground Fixed GF40  |
|                          | 59 000 h  | 58 000 h  | at 48 V, 20 A and +25 °C; Ground Fixed GF25  |

## 16. Functional Diagram

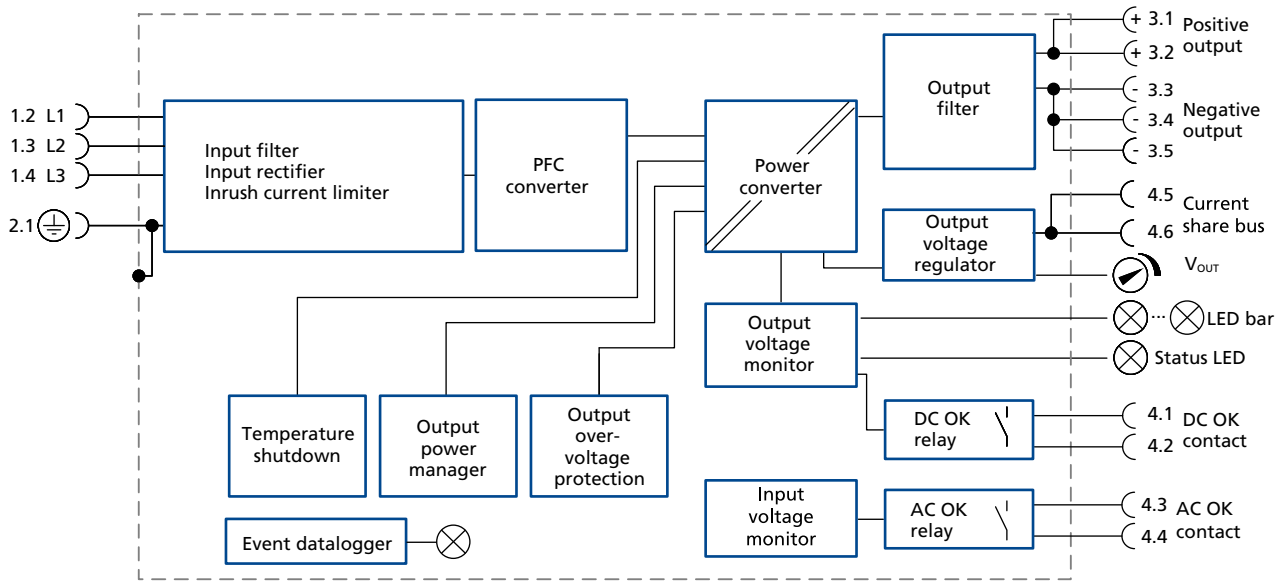

Fig. 16-1: Functional Diagram TP960.481

## 17. Terminals and Wiring

The terminals are IP20 finger safe constructed and suitable for field- and factory wiring.

|   | Input terminals        | Output terminals       | Signal terminals         |
|---|------------------------|------------------------|--------------------------|
| Type                                    | Spring clamp terminals | Spring clamp terminals | Push-in terminals        |
| Solid wire                              | max. 6 mm <sup>2</sup> | max. 6 mm <sup>2</sup> | max. 1.5 mm <sup>2</sup> |
| Stranded wire                           | max. 4 mm <sup>2</sup> | max. 4 mm <sup>2</sup> | max. 1.5 mm <sup>2</sup> |
| American wire gauge                     | AWG 20-10              | AWG 20-10              | AWG 28-14                |
| Max. wire diameter (including ferrules) | 2.8 mm                 | 2.8 mm                 | 1.5 mm                   |
| Wire stripping length                   | 11 mm                  | 11 mm                  | 8 mm                     |

### Instructions for wirings:

- a) Use appropriate copper cables that are designed for minimum operating temperatures of:
  - +60 °C for ambient temperature up to +45 °C and
  - +75 °C for ambient temperature up to +60 °C
  - +90 °C for ambient temperature up to +70 °C.
- b) Follow national installation codes and installation regulations!
- c) Ensure that all strands of a stranded wire enter the terminal connection!
- d) Do not use the unit without PE connection.
- e) Unused terminal compartments should be securely tightened.
- f) Ferrules are allowed.

### Daisy chaining power path and current share bus:

The power supplies can operate in parallel to distribute the current evenly. This means that each power supply provides the same amount of current to the load. The current share bus has the advantage of keeping the output voltage constant, no matter how much load is connected.

If more than three devices are connected in parallel, a diode, fuse or circuit breaker with a rating of 40 A is required on each output. If devices are connected in parallel, maximum one ground connection of the output voltage is allowed.

When power supplies are connected in parallel, the share bus pins need to be daisy chained. Daisy chaining (paralleling power supplies by jumping from one power supply output to the next) is allowed as long as the average output current through one terminal pin does not exceed 51 A.

To enable parallel operation:

- ⇒ Adjust the output voltage potentiometer of each unit to the same value. The current-sharing system can compensate up to 0.4 V voltage difference, but it is better to have them as close as possible.
- ⇒ Connect the bus-pins of each unit (pin 4.5 and 4.6) with a wire. This creates an active current-sharing system that balances the current among the power supplies. The power return pins (pin 3.3 or 3.4) serve as the return path for the current-sharing signal.

If the current is higher, use separate distribution terminal block as shown in Fig. 17-2 or a load with multiterminal as shown in Fig. 17-3.

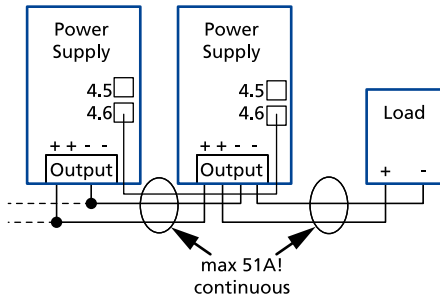

Fig. 17-1: Daisy chaining of outputs

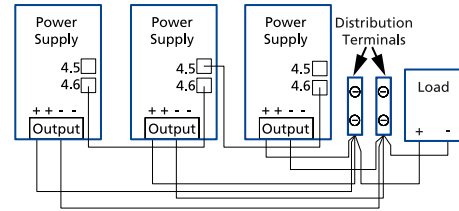

Fig. 17-2: Using distribution terminals

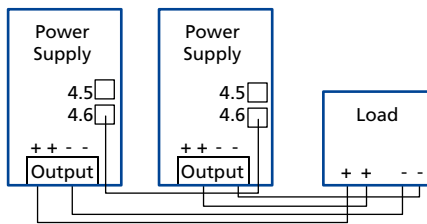

Fig. 17-3: Load with multiterminal

## 18. Front Side and User Elements

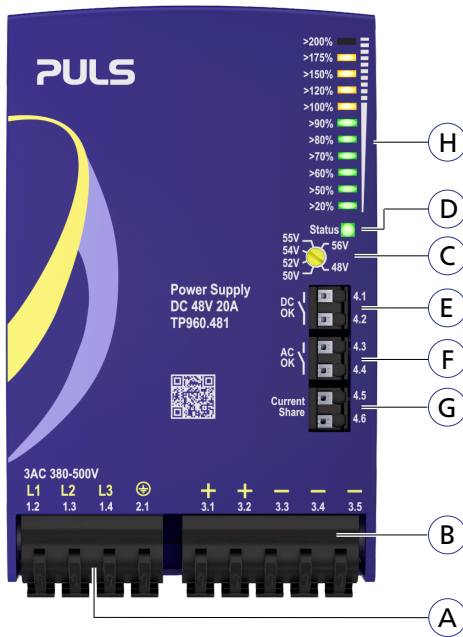







Fig. 18-1: Front side

- A Input terminals**
- |     |    |                             |
|-----|----|-----------------------------|
| 1.2 | L1 |                             |
| 1.3 | L2 | Line input                  |
| 1.4 | L3 |                             |
| 2.1 | ⊕  | PE (Protective Earth) input |
- B Output terminals**  
Identical poles are internally connected.
- |     |     |                          |
|-----|-----|--------------------------|
| 3.1 | (+) | Positive output          |
| 3.2 | (+) |                          |
| 3.3 | (-) |                          |
| 3.4 | (-) | Negative output (return) |
| 3.5 | (-) |                          |
- C Output voltage potentiometer**  
Factory setting: 48 V  
Adjustable in 6 steps: 48 V, 50 V, 52 V, 54 V, 55 V, 56 V
- D Status LED**  
Green, when the output voltage is > 90 % of the adjusted output voltage.
- E DC OK relay contact**
- |     |               |  |
|-----|---------------|--|
| 4.1 | Open /        | The DC OK relay monitors the output voltage. When the contact is closed, the status LED is on. |
| 4.2 | close contact |  |
- F AC OK relay contact**
- |     |               |   |
|-----|---------------|---|
| 4.3 | Open /        | The AC OK relay monitors the AC input voltage. In case of failure, the status LED turns yellow. |
| 4.4 | close contact |   |
- G Current share bus**
- |     |  |
|-----|--|
| 4.5 | The current share bus distributes the current evenly for power supplies operating in parallel. |
| 4.6 |  |
- H LED bar**

## 19. Status LED Signaling

The status LED (D) displays different running conditions of the PSU in real-time.

|   |  |
|---|--|
|  | <b>Green</b><br>The output voltage is above 90 %. The DC OK relay is closed. All outputs are operating according their settings. |
|  | <b>Yellow (steady on)</b><br>Various input voltage failures  |
|  | <b>Yellow (blinking 1 Hz)</b><br>Pre-warning for overtemperature   |
|  | <b>Red (steady on)</b><br>AC input drop below the specified voltage, the output voltage turns off                                |
|  | <b>Red (blinking 1 Hz)</b><br>Hiccup <sup>PLUS</sup> mode or overtemperature protection  |
|  | <b>Off</b><br>Output voltage is off or power supply is not powered.  |

## 20. EMC

The device is designed for industrial environments. Do not use in residential, commercial and light-industrial environments. All results assume a 3-phase operation of the device.

| <b>EMC Immunity</b>      | According to generic standards: EN IEC 61000-6-1 and EN IEC 61000-6-2 |   |                |             |
|--------------------------|---|---|----------------|-------------|
| Electrostatic discharge  | EN 61000-4-2  | contact discharge   | 8 kV           | Criterion A |
|                          |   | air discharge   | 15 kV          | Criterion A |
| Electromagnetic RF field | EN 61000-4-3  | 80 MHz - 1 GHz  | 20 V/m         | Criterion A |
|                          |   | 1 GHz - 6 GHz   | 10 V/m         | Criterion A |
| Fast transients (Burst)  | EN 61000-4-4  | input lines   | 4 kV           | Criterion A |
|                          |   | output lines  | 2 kV           | Criterion A |
|                          |   | DC OK signal (coupling clamp)   | 2 kV           | Criterion A |
|                          |   | AC OK signal (coupling clamp)   | 2 kV           | Criterion A |
| Surge voltage on input   | EN 61000-4-5  | L1 → L2, L2 → L3, L1 → L3   | 2 kV           | Criterion A |
|                          |   | L1 / L2 / L3 → PE   | 4 kV           | Criterion A |
| Surge voltage on output  | EN 61000-4-5  | (+) → (-)   | 1 kV           | Criterion A |
|                          |   | (+) / (-) → PE  | 1 kV           | Criterion A |
| Surge voltage on signals | EN 61000-4-5  | DC OK signal → PE   | 1 kV           | Criterion A |
|                          |   | AC OK signal → PE   | 1 kV           | Criterion A |
| Conducted disturbance    | EN 61000-4-6  | 0.15 - 80 MHz   | 20 V           | Criterion A |
| Mains voltage dips       | EN 61000-4-11   | 0 % of 380 Vac (0 Vac)  | 1 cycle        | Criterion A |
|                          |   | 0 % of 500 Vac (0 Vac)  | 1 cycle        | Criterion A |
|                          |   | 40 % of 380 Vac (152 Vac)   | 200 ms         | Criterion A |
|                          |   | 40 % of 500 Vac (200 Vac)   | 200 ms         | Criterion A |
|                          |   | 70 % of 380 Vac (266 Vac)   | 500 ms         | Criterion A |
|                          |   | 70 % of 500 Vac (350 Vac)   | 500 ms         | Criterion A |
| Voltage interruptions    | EN 61000-4-11   | 0 Vac   | 5000 ms        | Criterion C |
| Voltage sags             | SEMI F47 0706   | dips on two phases according to section 7.2. of the SEMI F47 standard |                |             |
|                          |   | 80 % of 380 Vac (304 Vac)   | 1000 ms        | Criterion A |
|                          |   | 70 % of 380 Vac (266 Vac)   | 500 ms         | Criterion A |
|                          |   | 50 % of 380 Vac (190 Vac)   | 200 ms         | Criterion A |
| Powerful transients      | VDE 0160  | over entire load range  | 1550 V, 1.3 ms | Criterion A |

**Performance criterions:**

- A:** Power supply shows normal operation behavior within the defined limits.
- B:** Device shows normal operation behavior within the defined limits.
- C:** Temporary loss of function is possible. Power supply may shut-down and restarts by itself. No damage or hazards for the power supply will occur.

| <b>EMC Emission</b>             | According to generic standards: EN IEC 61000-6-3, EN IEC 61000-6-8 and EN IEC 61000-6-4 |  |
|---------------------------------|---|--|
| Conducted emission input lines  | EN 55011, EN 55032, FCC Part 15, CISPR 11, CISPR 32                                     | Class B  |
| Conducted emission output lines | IEC/CISPR 16-1-2, IEC/CISPR 16-2-1  | Limits for DC power ports according to EN 61000-6-8 are fulfilled. |
| Radiated emission               | EN 55011, EN 55032  | Class B  |
| Harmonic input current          | EN 61000-3-2  | fulfilled for Class A equipment                                    |
| Voltage fluctuations, flicker   | EN 61000-3-3  | fulfilled with constant current loads, non pulsing                 |

This device complies with FCC Part 15 rules.

Operation is subjected to following two conditions: (1) this device may not cause harmful interference, and (2) this device must accept any interference received, including interference that may cause undesired operation.

|                              |   |   |
|------------------------------|---|---|
| <b>Switching Frequencies</b> | The power supply has three converters with three different switching frequencies included. One is nearly constant. The others are variable. |   |
| PFC converter                | 20 kHz to 200 kHz   | input voltage and output load dependent |
| Main converter               | 60 kHz to 140 kHz   | output load dependent                   |
| Auxiliary converter          | 54-66 kHz   |   |
| Microcontroller clock        | 64 MHz  |   |

## 21. Environment

|                                       |   |   |
|---------------------------------------|---|---|
| Operational temperature <sup>1)</sup> | -40 °C to +70 °C  | reduce output power according to Fig. 21-1                                    |
| Storage temperature                   | -40 °C to +80 °C  | for storage and transportation  |
| Output derating                       | 12.8 W/K  | between +45 °C and +60 °C   |
|                                       | 15 W/K  | between +60 °C and +70 °C   |
|                                       | 60 W / 1000 m or<br>5 °C / 1000 m   | for altitudes > 2000 m, see Fig. 21-2   |
|                                       | The derating is not hardware controlled. The user has to take care by himself to stay below the derated current limits in order not to overload the unit. |   |
| Humidity                              | 5 - 95% r.h.  | according to IEC 60068-2-30<br>Do not energize while condensation is present. |
| Atmospheric pressure                  | 54 - 110 kPa  | for details, see Fig. 21-2  |
| Altitude                              | 0 to 2000 m   | without any restrictions  |
|                                       | 2000 to 5000 m  | reduce output power or ambient temperature, see Fig. 21-2.                    |
| Over-voltage category                 | III   | IEC 60664-1 up to 2000 m  |
|                                       | II  | IEC 60664-1 2000 m to 5000 m  |
| Degree of pollution                   | 2   | IEC/UL 61010-2-201, not conductive  |
| Vibration sinusoidal                  | 2 - 17.8 Hz: ±1.6 mm;<br>17.8 - 500 Hz: 2 g<br>2 hours / axis   | IEC 60068-2-6   |
| Shock                                 | 15 g 6 ms, 10 g 11 ms<br>3 bumps / direction, 18 bumps<br>in total  | IEC 60068-2-27  |
|                                       | Shock and vibration is tested in combination with DIN rails EN 60715 with a height of 15 mm and a thickness of 1.3 mm and standard orientation.           |   |
| Audible noise                         | Some audible noise may be emitted from the power supply during no load, overload or short circuit.  |   |

1) The operational temperature is the same as the ambient or surrounding temperature. It is defined as the air temperature 2.5 cm below the device.

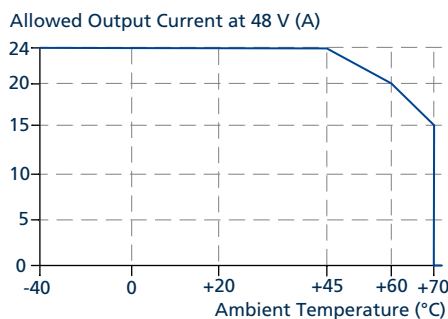

Fig. 21-1: Output current vs. ambient temp.

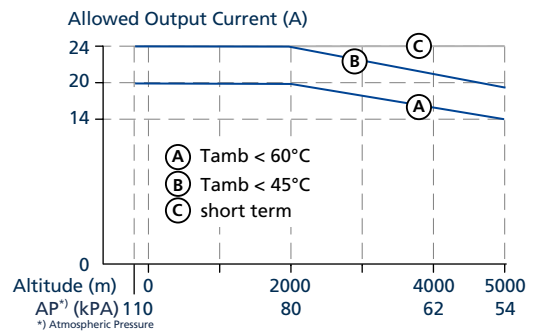

Fig. 21-2: Output current vs. altitude

## 22. Protection Features

|                               |                            |  |
|-------------------------------|----------------------------|--|
| Output overvoltage protection | typ. 59 Vdc<br>max. 60 Vdc | In case of an internal power supply defect, a redundant circuit limits the maximum output voltage to 60 V. The output switches off and performs three restart attempts. If the failure continues, the output shuts down. Cycle input power to reset. |
| Degree of protection          | IP20                       | EN/IEC 60529   |
| Penetration protection        | > 5 mm                     | e.g. screws, small parts   |
| Overtemperature protection    | included                   | output shut-down with automatic restart  |
| Input transient protection    | MOV (Metal Oxide Varistor) | for protection values, see chapter 20 (EMC)  |
| Internal input fuse           | included                   | not user replaceable   |

## 23. Safety Features

|                           |  |   |
|---------------------------|--|---|
| Input / output separation | SELV<br>double or reinforced galvanic insulation | IEC/UL 61010-2-201  |
| Class of protection       | I  | PE (Protective Earth) connection required   |
| Isolation resistance      | > 500 MOhm                                       | at delivered condition between input and output, measured with 500 Vdc                      |
|                           | > 500 MOhm                                       | at delivered condition between input and PE, measured with 500 Vdc                          |
|                           | > 500 MOhm                                       | at delivered condition between output and PE, measured with 500 Vdc                         |
| PE resistance             | < 0.1 Ohm  | resistance between PE terminal and the housing in the area of the DIN rail mounting bracket |
| PE conductor current      | typ. 0.6 mA                                      | at 3x 380 Vac 50 Hz, TN-, TT-mains  |
|                           | typ. 0.7 mA                                      | at 3x 480 Vac 50 Hz, TN-, TT-mains  |

## 24. Dielectric Strength

The output voltage is floating and has no ohmic connection to the ground.

Type and factory tests are conducted by the manufacturer. Field tests may be conducted in the field using the appropriate test equipment which applies the voltage with a slow ramp (2 s up and 2 s down). Connect all input-terminals together as well as all output poles before conducting the test. When testing, set the cut-off current settings to the value in the table below.

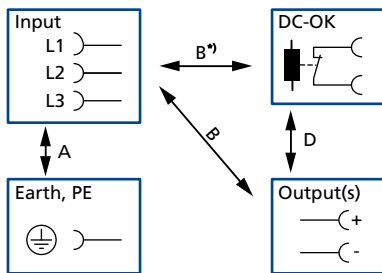



Fig. 24-1: Dielectric strength

|  | A        | B        | C       | D       |
|--|----------|----------|---------|---------|
| Type test (60 s)                       | 2210 Vac | 3600 Vac | n / a   | 500 Vac |
| Factory test (5 s)                     | 2200 Vac | 2200 Vac | n / a   | 500 Vac |
| Field test (5 s)                       | 2000 Vac | 2000 Vac | n / a   | 500 Vac |
| Cut-off current setting for field test | > 10 mA  | > 10 mA  | > 20 mA | > 10 mA |



To fulfil the PELV requirements according to EN 60204-1 § 6.4.1, we recommend that either the (+) pole, the (-) pole or any other part of the output circuit shall be connected to the protective earth system. This helps to avoid situations in which a load starts unexpectedly or can not be switched off when unnoticed earth faults occur.

**B\*)** When testing input to DC OK ensure that the max. voltage between DC OK and the output is not exceeded (column D). We recommend connecting DC OK pins and the output pins together when performing the test.

## 25. Approved, Fulfilled or Tested Standards

|           |   |   |
|-----------|---|---|
| UL 61010  |  | UL Certificate<br>Listed equipment for category NMTR - UL 61010-2-201 - Electrical equipment for measurement, control and laboratory use - Particular requirements for control equipment<br>Applicable for US and Canada<br>E-File: E198865 |
| IEC 61010 | <b>Safety</b> ✓   | Manufacturer's Declaration<br>IEC 61010-2-201 - Electrical Equipment for Measurement, Control and Laboratory Use - Particular requirements for control equipment  |
| IEC 61010 | <b>CB Report</b>  | CB Scheme Certificate<br>IEC 61010-2-201 - Electrical Equipment for Measurement, Control and Laboratory Use - Particular requirements for control equipment   |
| Semi F47  | <b>SEMI F47</b>   | Test Report<br>Voltage Sag Immunity for Semiconductor Processing Equipment  |

## 26. Regulatory Product Compliance

|                                     |   |   |
|-------------------------------------|---|---|
| EU Declaration of Conformity        |  | The CE mark indicates conformance with the European <ul style="list-style-type: none"> <li>- EMC directive</li> <li>- Low-voltage directive (LVD)</li> <li>- RoHS directive</li> </ul>  |
| REACH Regulation                    | <b>REACH</b> ✓  | Manufacturer's Declaration<br>EU Regulation regarding the Registration, Evaluation, Authorisation and Restriction of Chemicals<br>EU Regulation 1907 / 2006   |
| WEEE Regulation                     |  | Manufacturer's Declaration<br>EU Directive on Waste Electrical and Electronic Equipment Registered in Germany as business to business (B2B) products.<br>EU Directive 2012/19/EU<br>WEEE-Reg.-Nr. DE 55837529   |
| RoHS (China RoHS 2)                 |  | Manufacturer's Statement<br>Administrative Measures for the Restriction of the Use of Hazardous Substances in Electrical and Electronic Products 25 years   |
| IEC 61558-2-16 (Annex BB) (planned) | Safety Isolating Transformer  | Test Certificate<br>IEC 61558-2-16 - Safety of transformers, reactors, power supply units and similar products for supply voltages up to 1100 V.<br>Particular requirements and tests for switch mode power supply units and transformers for switch mode power supply units. |

## 27. Physical Dimensions and Weight

|  |  |
|--|--|
| Width  | 79 mm  |
| Height   | 124 mm   |
| Depth  | 136 mm   |
|  | The DIN rail depth must be added to the unit depth to calculate the total required installation depth. |
| Weight   | 1100 g   |
| DIN rail   | Use 35 mm DIN rails according to EN 60715 or EN 50022 with a height of 7.5 or 15 mm.                   |
| Housing material   | Body: Aluminium alloy<br>Cover: Zinc-plated steel  |
| Installation clearances<br>(top / bottom / left / right) | 40 / 30 / 5 / 5 mm   |

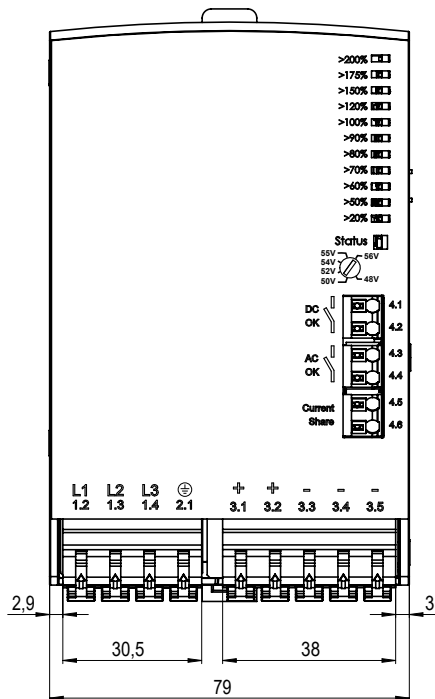

Fig. 27-1: Front view

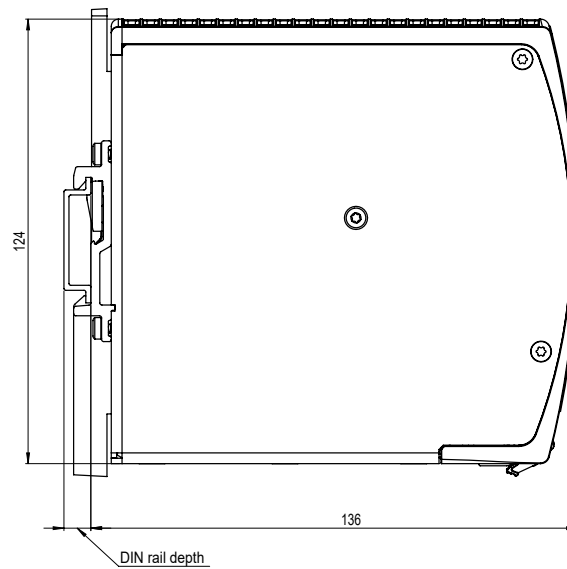

Fig. 27-2: Side view

All dimensions in mm unless otherwise noted.

## 28. Accessories

### 28.1. ZM10.Wall - Wall / Panel Mounting Bracket

This bracket is used to mount the devices on a wall / panel without utilizing the DIN rail. The bracket can be mounted without detaching the DIN rail brackets from the power supply.

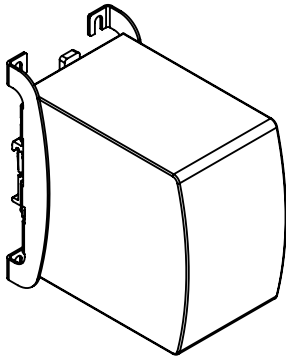

Fig. 28-1: Isometric view

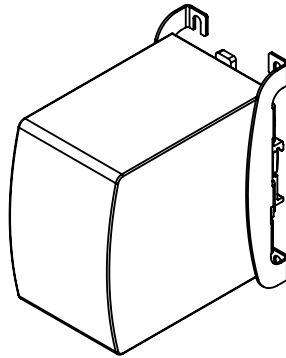

Fig. 28-2: Isometric view

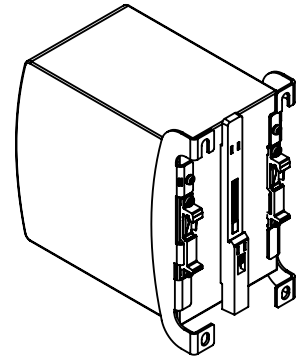

Fig. 28-3: Isometric view

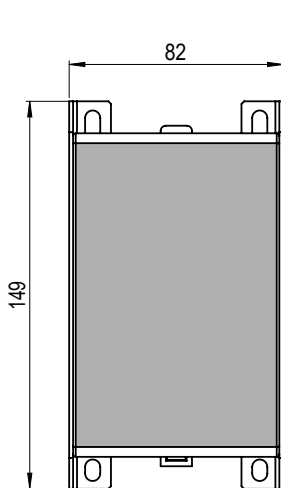

Fig. 28-4: Wall / panel mounting, front view

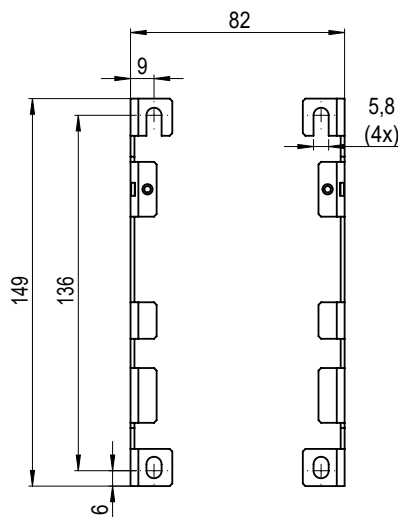

Fig. 28-5: Hole pattern for wall mounting

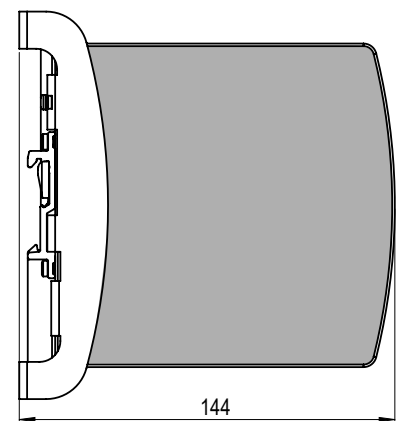

Fig. 28-6: Wall / panel mounting, side view

All dimensions in mm unless otherwise noted.

## 29. Application Notes

### 29.1. Using Only 2 Legs of a 3-Phase System

No external protection devices are required to protect against a phase-loss failure.

This power supply can also be permanently operated on two legs of a 3-phase system. However, it is not recommended for this power class since the supplying 3-phase network can become unbalanced.

The output power must be reduced according to the curves below when operation on only two legs of a 3-phase system. A long-term exceeding of these limits will result in a thermal shut-down of the unit.

A use below 340 Vac with more than 30 A output current can also result in a thermal shut-down.

During power-on, some start-up attempts can occur until a permanent output power is available.

EMC performance, hold-up time, losses and output ripple differ from a three phase operation. Therefore, check the suitability of your individual application.

Such use is not included in the UL approval. Additional tests might be necessary when the complete system has to be approved according to UL 508, UL 61010-2-201 or UL60950-1.

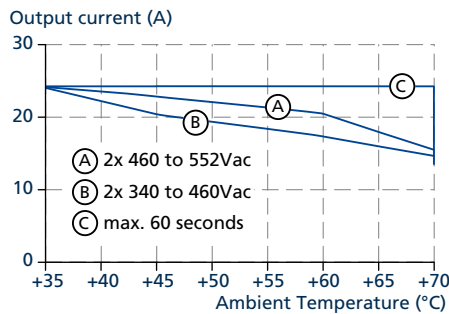
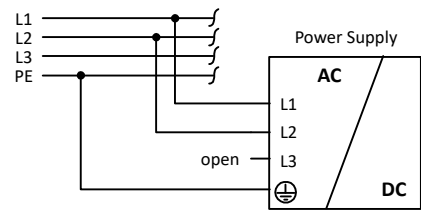

Fig. 29-1: Output current vs. ambient temperature

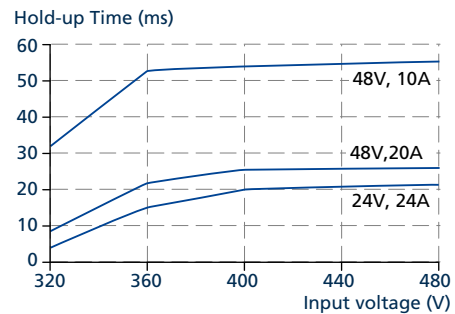

Fig. 29-2: Hold-up time vs. input voltage

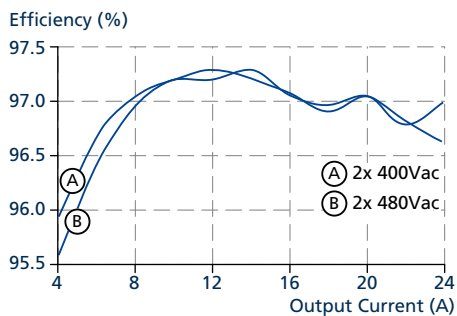

Fig. 29-3: Efficiency vs. output current at 48 V

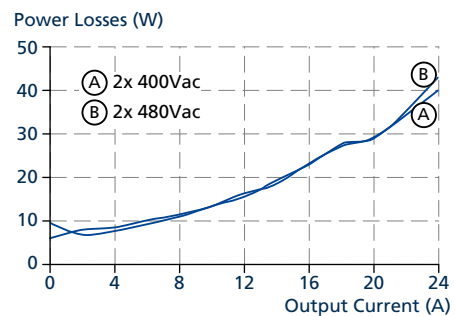

Fig. 29-4: Power Losses vs. output current at 48 V

## 29.2. Output Circuit Breakers

Standard miniature circuit breakers (MCB's or UL 1077 circuit breakers) are commonly used for AC-supply systems and may also be used on DC branches.

MCB's are designed to protect wires and circuits. If the ampere value and the characteristics of the MCB are adapted to the wire size that is used, the wiring is considered as thermally safe regardless of whether the MCB opens or not.

To avoid voltage dips and under-voltage situations in adjacent 48 V branches which are supplied by the same source, a fast (magnetic) tripping of the MCB is desired. A quick shutdown within 10 ms is necessary corresponding roughly to the ride-through time of PLC's. This requires power supplies with high current reserves and large output capacitors. Furthermore, the impedance of the faulty branch must be sufficiently small in order for the current to actually flow. The best current reserve in the power supply does not help if Ohm's law does not permit current flow. The following table has typical test results showing which B- and C-Characteristic MCBs magnetically trip depending on the wire cross section and wire length.

Maximum wire length <sup>1)</sup> for a fast (magnetic) tripping:

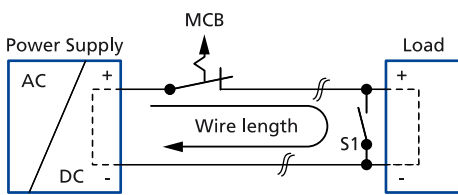

S1... Fault simulation switch

Fig. 29-5: Test circuit

|          | 0.75 mm <sup>2</sup> | 1.0 mm <sup>2</sup> | 1.5 mm <sup>2</sup> | 2.5 mm <sup>2</sup> |
|----------|----------------------|---------------------|---------------------|---------------------|
| C - 2 A  | 85 m                 | 100 m               | 100 m               | 100 m               |
| C - 3 A  | 59 m                 | 75 m                | 100 m               | 100 m               |
| C - 4 A  | 44 m                 | 58 m                | 83 m                | 100 m               |
| C - 6 A  | 19 m                 | 26 m                | 38 m                | 63 m                |
| C - 8 A  | 16 m                 | 21 m                | 29 m                | 46 m                |
| C - 10 A | 14 m                 | 18 m                | 26 m                | 43 m                |
| C - 13 A | 6 m                  | 6 m                 | 11 m                | 16 m                |
| B - 6 A  | 45 m                 | 60 m                | 89 m                | 100 m               |
| B - 10 A | 23 m                 | 29 m                | 41 m                | 66 m                |
| B - 13 A | 17 m                 | 25 m                | 36 m                | 56 m                |
| B - 16 A | 14 m                 | 14 m                | 19 m                | 33 m                |
| B - 20 A | 4 m                  | 4 m                 | 7 m                 | 10 m                |

- 1) Don't forget to consider twice the distance to the load (or cable length) when calculating the total wire length (+ and - wire).

## 29.3. Parallel Use for Redundancy

Power supplies can be paralleled for redundancy to gain higher system availability. Redundant systems require a certain amount of extra power to support the load in case one power supply unit fails. The simplest way is to put two devices in parallel. This is called a 1+1 redundancy. In case one power supply unit fails, the other one is automatically able to support the load current without any interruption. Redundant systems for a higher power demand are usually built in a N +1 method. E.g. six devices, each rated for 40 A are paralleled to build a 200 A redundant system. For N+1 redundancy the same restrictions apply as for increasing the output power, see also chapter 17.

**Please note:** This simple way to build a redundant system does not cover failures such as an internal short circuit in the secondary side of the power supply. In such a case, the defective unit becomes a load for the other devices and the output voltage can not be maintained anymore. Further information and wiring configurations can be found in chapter 17.

### Recommendations for building redundant power systems:

- a) Use separate input fuses for each power supply. A separate source for each supply when possible increases the reliability of the redundant system.
- b) Monitor the individual power supply units. Therefore, use the DC OK relay contact of the power supply.
- c) It is desirable to set the output voltages of all units to the same value ( $\pm 100$  mV) or leave it at the factory setting.

### 29.4. Series Operation

Power supplies of the same type can be connected in series for higher output voltages. It is possible to connect as many units in series as needed, providing the sum of the output voltage does not exceed 150 Vdc. Voltages with a potential above 60 Vdc are not SELV any more and can be dangerous. Such voltages must be installed with a protection against touching.

Earthing of the output is required when the sum of the output voltage is above 60 Vdc.

Avoid return voltage (e.g. from a decelerating motor or battery) which is applied to the output terminals.

Keep an installation clearance of 15 mm (left / right) between two power supplies and avoid installing the power supplies on top of each other. Do not use power supplies in series in mounting orientations other than the standard mounting orientation (terminals on the bottom of the unit).

Pay attention that leakage current, EMI, inrush current, harmonics will increase when using multiple power supplies.

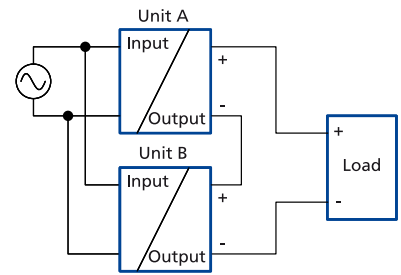

### 29.5. Mounting Orientations

Mounting orientations other than input terminals on the bottom and output on the top require a reduction in continuous output power or a limitation in the maximum allowed ambient temperature.

The amount of reduction influences the lifetime expectancy of the power supply. Therefore, two different derating curves for continuous operation can be found below:

The listed lifetime and MTBF values from this datasheet apply only for the standard mounting orientation.

The following curves give an indication for allowed output currents for altitudes up to 2000m.

**Curve A** Recommended output current.

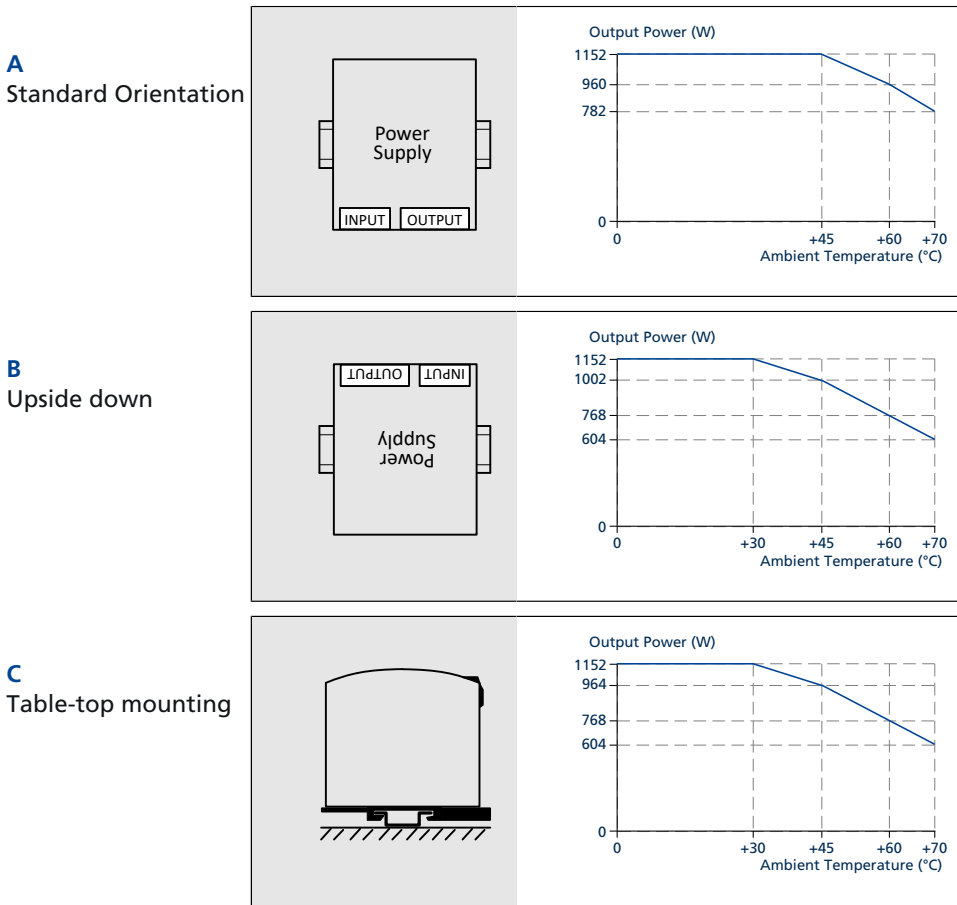

All parameters are specified at 48 V, 20 A, 3x 400 Vac, +25 °C ambient and after a 5 minutes run-in time unless otherwise noted.

**D**  
Horizontal cw

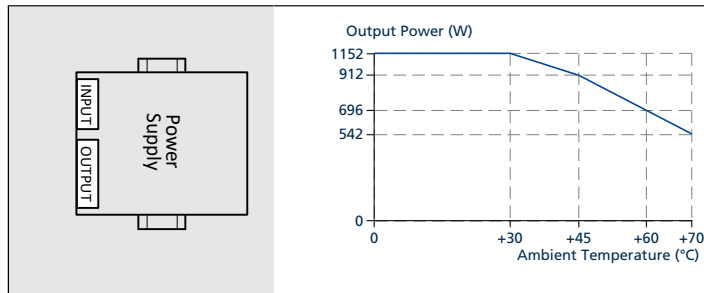

**E**  
Horizontal ccw

