



POWER SUPPLY

- 100-240V Wide Range Input
- NEC Class 2 Compliant
- Adjustable Output Voltage
- Efficiency up to 90.4%
- Low No-load Losses and Excellent Partial-load Efficiency
- Compact Design, Width only 45mm
- Electronic Inrush Current Limitation
- Operation down to -40°C
- Full Output Power up to +60°C
- Large International Approval Package
- 3 Year Warranty

GENERAL DESCRIPTION

A compact size, light weight, simple mounting onto the DIN-rail and the utilization of only quality components are what makes the MiniLine power supplies so easy to use and install within seconds.

A rugged electrical and mechanical design as well as a high immunity against electrical disturbances on the mains provides reliable output power. This offers superior protection for equipment which is connected to the public mains network or is exposed to a critical industrial environment.

The MiniLine series offers output voltages from 5 to 56Vdc and a power rating from 15W to 120W.

The specialty of the ML60.242 is the electronic inrush current limitation and the suitability for very low ambient temperatures. The unit is fully specified down to -40°C.

The supplementary MiniLine decoupling diode module MLY10.241 allows building of redundant systems or to protect against back-feeding voltages.

SHORT-FORM DATA

Output voltage	DC 24V	
Adjustment range	24 - 28V	
Output current	2.5A at 24V 2.1A at 28V	
Output power	60W	
Output ripple	< 50mVpp	20Hz to 20MHz
Input voltage	AC 100-240V	-15% / +10%
Mains frequency	50-60Hz	±6%
AC Input current	1.05 / 0.66A	at 120 / 230Vac
Power factor	0.54 / 0.44	at 120 / 230Vac
AC Inrush current	typ. 6A	input voltage and temperature independent
DC Input	88-375Vdc	below 100Vdc derating required
Efficiency	88.5 / 90.4%	at 120 / 230Vac
Losses	7.8 / 6.4W	at 120 / 230Vac
Temperature range	-40°C to +70°C	operational
Derating	1.5W/°C	+60 to +70°C
Hold-up time	typ. 24 / 107ms	at 120 / 230Vac
Dimensions	45x75x91mm	WxHxD
Weight	250g / 0.55lb	

ORDER NUMBERS

Power Supply	ML60.242	24-28V Standard unit
Accessory	MLY10.241	Redundancy Module
	UF20.241	Buffer Module
	ZM3.WALL	Wall mount bracket

MARKINGS



UL 508



UL 60950-1



dnvgl.com/af

Marine



Class I Div 2

NEC CLASS 2



INDEX



	Page		Page
1. Intended Use	3	21. Accessory.....	19
2. Installation Instructions	3	21.1. ZM3.WALL – Wall Mount Bracket.....	19
3. AC-Input.....	5	21.2. MLY10.241 - Redundancy Module.....	19
4. Input Inrush Current	6	21.3. UF20.241 - Buffer Module.....	19
5. Output	7	22. Application Notes.....	20
6. Hold-up Time.....	8	22.1. Peak Current Capability	20
7. DC-Input.....	8	22.2. Back-feeding Loads	20
8. Efficiency and Power Losses.....	9	22.3. Charging of Batteries	21
9. Functional Diagram.....	10	22.4. External Input Protection.....	21
10. Front Side and User Elements.....	10	22.5. Parallel Use to Increase Output Power....	21
11. Terminals and Wiring.....	11	22.6. Parallel Use for Redundancy.....	22
12. Lifetime Expectancy and MTBF.....	11	22.7. Daisy Chaining of Outputs	22
13. EMC.....	12	22.8. Inductive and Capacitive Loads.....	22
14. Environment.....	13	22.9. Series Operation	23
15. Protection Features	14	22.10. Operation on Two Phases	23
16. Safety Features.....	14	22.11. Use Without PE on the Input.....	23
17. Dielectric Strength	15	22.12. Use at Low Temperatures (-25°C / -40°C).	24
18. Approvals and Fulfilled Standard.....	16	22.13. Use in a Tightly Sealed Enclosure	24
19. Regulatory Compliance.....	17	22.14. Mounting Orientations	25
20. Physical Dimensions and Weight.....	18		

The information presented in this document is believed to be accurate and reliable and may change without notice.

The housing is patent by PULS (US patent No US D442,923S).

No part of this document may be reproduced or utilized in any form without permission in writing from the publisher.

TERMINOLOGY AND ABBREVIATIONS

PE and  symbol	PE is the abbreviation for Protective Earth and has the same meaning as the symbol  .
Earth, Ground	This document uses the term “earth” which is the same as the U.S. term “ground”.
T.B.D.	To be defined, value or description will follow later.
AC 230V	A figure displayed with the AC or DC before the value represents a nominal voltage with standard tolerances (usually ±15%) included. E.g.: DC 12V describes a 12V battery disregarding whether it is full (13.7V) or flat (10V)
230Vac	A figure with the unit (Vac) at the end is a momentary figure without any additional tolerances included.
50Hz vs. 60Hz	As long as not otherwise stated, AC 100V and AC 230V parameters are valid at 50Hz and AC 120V parameters are valid at 60Hz mains frequency.
may	A key word indicating flexibility of choice with no implied preference.
shall	A key word indicating a mandatory requirement.
should	A key word indicating flexibility of choice with a strongly preferred implementation.

1. INTENDED USE

This device is designed for installation in an enclosure and is intended for commercial use, such as in industrial control, process control, monitoring and measurement equipment or the like.

Do not use this device in equipment, where malfunctioning may cause severe personal injury or threaten human life without additional appropriate safety devices, that are suited for the end application.

If this device is used in a manner outside of its specification, the protection provided by the device may be impaired.

2. INSTALLATION INSTRUCTIONS

Install device in an enclosure providing protection against electrical, mechanical and fire hazards.

Install the device onto a DIN-rail according to EN 60715 with the input terminals on the bottom of the device. Other mounting orientations require a reduction in output current.

Make sure that the wiring is correct by following all local and national codes. Use appropriate copper cables that are designed for a minimum operating temperature of 60°C for ambient temperatures up to +45°C, 75°C for ambient temperatures up to +60°C and 90°C for ambient temperatures up to +70°C. Ensure that all strands of a stranded wire enter the terminal connection. Unused screw terminals should be securely tightened.

The device is designed for pollution degree 2 areas in controlled environments. No condensation or frost is allowed.

The housing of the device provides a degree of protection of IP20. The housing does not provide protection against spilled liquids.

The isolation of the device is designed to withstand impulse voltages of overvoltage category III according to IEC 60664-1.

The device is designed as "Class of Protection" I equipment according to IEC 61140. Do not use without a proper PE (Protective Earth) connection.

The device is suitable to be supplied from TN, TT or IT mains networks. The continuous voltage between the input terminal and the PE potential must not exceed 300Vac.

The input can also be powered from batteries or similar DC sources. The continuous voltage between the supply voltage and the PE/ground potential must not exceed 375Vdc. Connect the +pole to L and the -pole to the N terminal.

A disconnecting means shall be provided for the input of the device.

The device is designed for convection cooling and does not require an external fan. Do not obstruct airflow and do not cover ventilation grid!

The device is designed for altitudes up to 5000m (16400ft). Above 2000m (6560ft) a reduction in output current and over voltage category is required.

Keep the following minimum installation clearances: 40mm on top, 20mm on the bottom, 0mm left and right side. Increase the 0mm to 15mm in case the adjacent device is a heat source.

The device is designed, tested and approved for branch circuits up to 20A without additional protection device. If an external fuse is utilized, do not use circuit breakers smaller than 6A B- or 3A C-Characteristic to avoid a nuisance tripping of the circuit breaker.

The maximum surrounding air temperature is +70°C (+158°F). The operational temperature is the same as the ambient or surrounding air temperature and is defined 2cm below the device.

The device is designed to operate in areas between 5% and 95% relative humidity.

⚠ WARNING Risk of electrical shock, fire, personal injury or death.

- Do not use the power supply without proper grounding (Protective Earth). Use the terminal on the input block for earth connection.
- Turn power off before working on the device. Protect against inadvertent re-powering.
- Make sure that the wiring is correct by following all local and national codes.
- Do not modify or repair the unit.
- Do not open the unit as high voltages are present inside.
- Use caution to prevent any foreign objects from entering into the housing.
- Do not use in wet locations or in areas where moisture or condensation can be expected.
- Do not touch during power-on, and immediately after power-off. Hot surface may cause burns.

Notes for use in hazardous location areas:

The power supply is suitable for use in Class I Division 2 Groups A, B, C, D locations.

WARNING EXPLOSION HAZARDS!

Substitution of components may impair suitability for this environment.

Do not disconnect the unit or operate the voltage adjustment unless power has been switched off or the area is known to be non-hazardous.

3. AC-INPUT

AC input	nom.	AC 100-240V	-15% / +10%, TN/TT/IT-mains
AC input range		85-264Vac	continuous operation, reduce output power linearly to 50W between 90Vac and 85Vac at ambient temperatures above +45°C, see Fig. 3-5
		264-300Vac	< 0.5s
Allowed voltage L or N to earth	max.	264Vac or 375Vdc	
Input frequency	nom.	50-60Hz	±6%
Turn-on voltage	typ.	75Vac	steady-state value, see Fig. 3-1
Shut-down voltage	typ.	65Vac	steady-state value, see Fig. 3-1

		AC 100V	AC 120V	AC 230V	
Input current (rms)	typ.	1.24A	1.05A	0.66A	at 24V, 2.5A see Fig. 3-5
Power factor *)	typ.	0.56	0.54	0.44	at 24V, 2.5A see Fig. 3-4
Crest factor **)	typ.	3.4	3.7	4.0	at 24V, 2.5A
Start-up delay	typ.	170ms	110ms	90ms	see Fig. 3-2
Rise time	typ.	50ms	50ms	60ms	at 24V, 2.5A, 0mF, see Fig. 3-2
		120ms	110ms	140ms	at 24V, 2.5A, 2.5mF
Turn-on overshoot	max.	200mV	200mV	200mV	see Fig. 3-2

*) The power factor is the ratio of the true (or real) power to the apparent power in an AC circuit.

**) The crest factor is the mathematical ratio of the peak value to RMS value of the input current waveform.

Fig. 3-1 Input voltage range

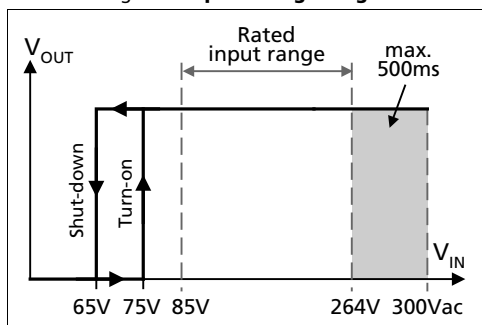

Fig. 3-2 Turn-on behavior, definitions

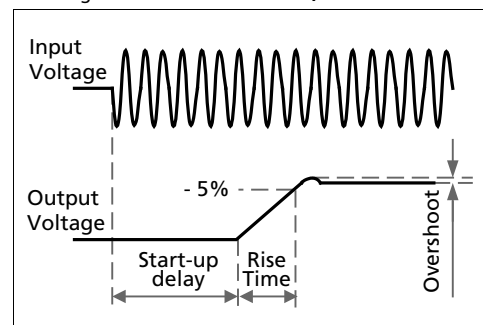

Fig. 3-3 Input current vs. output load at 24V

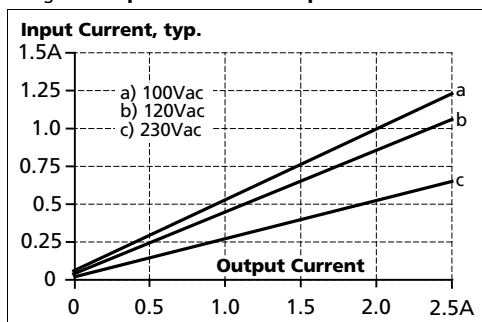

Fig. 3-4 Power factor vs. output load at 24V

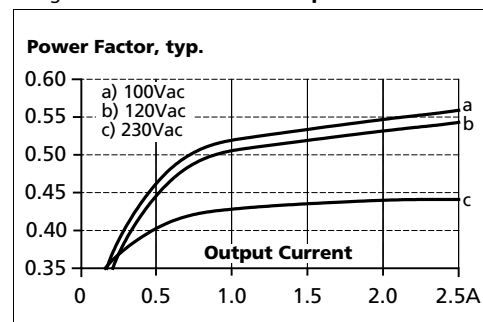
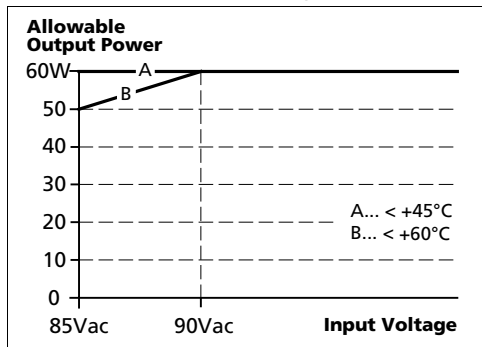

Fig. 3-5 De-rating requirements for low input voltages



4. INPUT INRUSH CURRENT

An electronic inrush current circuit limits the input inrush current after turn-on of the input voltage. The inrush current is input voltage and ambient temperature independent.

The charging current into EMI suppression capacitors is disregarded in the first microseconds after switch-on.

		AC 100V	AC 120V	AC 230V	
Inrush current	max.	8A _{peak}	8A _{peak}	8A _{peak}	between -40°C and +70°C
	typ.	6A _{peak}	6A _{peak}	6A _{peak}	between -40°C and +70°C
Inrush energy	max.	0.2A ² s	0.2A ² s	0.3A ² s	between -40°C and +70°C

Fig. 4-1 Input inrush current, typical behavior

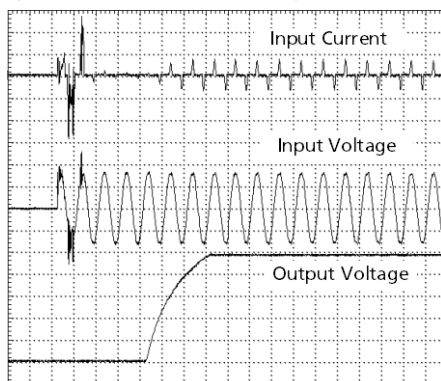

Input: 230Vac
 Output: 24V, 2.5A
 Ambient: 25°C
 Upper curve: Input current 2A/DIV
 Middle curve: Input voltage 200V/DIV
 Lower curve: Output voltage 5V/DIV
 Time basis: 20ms / DIV

5. OUTPUT

Output voltage	nom.	24V	
Adjustment range		24-28V	guaranteed
	max.	30V *)	at clockwise end position of potentiometer *)
Factory setting		24.5V	±0.2%, at full load, cold unit
Line regulation	max.	10mV	85-264Vac
Load regulation	max.	100mV	static value, 0A → 2.5A
Ripple and noise voltage	max.	50mVpp	20Hz to 20MHz, 50Ohm
Output capacitance	typ.	1 600µF	
Output current	nom.	2.5A	at 24V, see Fig. 5-1
	nom.	2.1A	at 28V, see Fig. 5-1
Output power	nom.	60W	
Short-circuit current	min.	3.6A	load impedance 400mOhm, see Fig. 5-1
	max.	6.2A	load impedance 400mOhm, see Fig. 5-1

*) This is the maximum output voltage which can occur at the clockwise end position of the potentiometer due to tolerances. It is not guaranteed value which can be achieved. The typical value is about 28.6V.

Fig. 5-1 **Output voltage vs. output current, typ.**

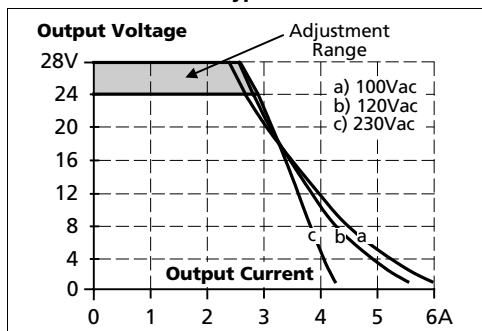

Peak current capability (up to several milliseconds)

The power supply can deliver a peak current which is higher than the specified short term current. This helps to start current demanding loads or to safely operate subsequent circuit breakers.

The extra current is supplied by the output capacitors inside the power supply. During this event, the capacitors will be discharged and causes a voltage dip on the output. Detailed curves can be found in chapter 22.1.

Peak current voltage dips	typ.	from 24V to 16V	at 5A for 50ms, resistive load
	typ.	from 24V to 15V	at 12.5A for 2ms, resistive load
	typ.	from 24V to 10.5V	at 12.5A for 5ms, resistive load

6. HOLD-UP TIME

		AC 100V	AC 120V	AC 230V	
Hold-up Time	typ.	36ms	54ms	218ms	at 24V, 1.25A, see Fig. 6-1
	typ.	15ms	24ms	107ms	at 24V, 2.5A, see Fig. 6-1

Note: At no load, the hold-up time can be up to several seconds. The green DC-ok lamp is also on during this time

Fig. 6-1 Hold-up time vs. input voltage

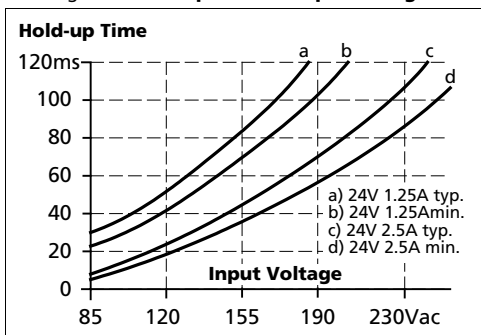
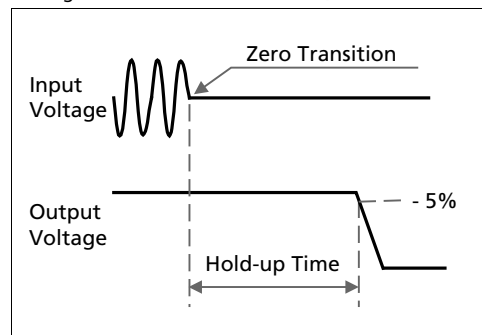

Fig. 6-2 Shut-down behavior, definitions



7. DC-INPUT

The power supply can also be supplied from a DC source. Use a battery or similar DC source. For other sources contact PULS. Connect the + pole to L and the - pole to N. Connect the PE terminal to an earth wire or to the machine ground.

DC input	nom.	DC 110-300V	-20%/+25%
DC input range		88-375Vdc	continuous operation, reduce output power according Fig. 7-2 at voltages below 110Vdc
Allowed Voltage L/N to Earth	max.	375Vdc	IEC 62103
DC input current	typ.	0.62A / 0.22A	110Vdc / 300Vdc, at 24V, 2.5A
Turn-on voltage	typ.	90Vdc	steady state value
Shut-down voltage	typ.	57Vdc	similar behavior as shown in Fig. 3-1

Fig. 7-1 Wiring for DC Input

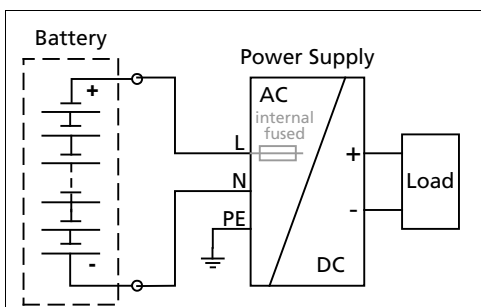
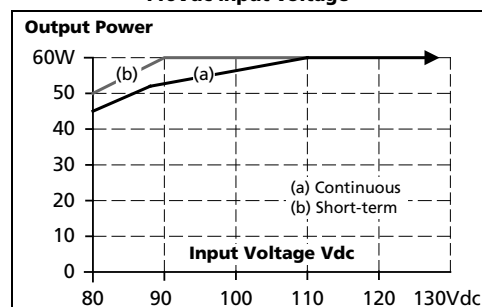

Fig. 7-2 Allowable output current below 110Vdc input voltage



8. EFFICIENCY AND POWER LOSSES

		AC 100V	AC 120V	AC 230V	
Efficiency	typ.	87.4%	88.5%	90.4%	at 24V, 2.5A (full load)
Power losses	typ.	0.45W	0.5W	0.85W	at 0A
	typ.	3.9W	3.7W	3.9W	at 24V, 1.25A (half load)
	typ.	8.6W	7.8W	6.4W	at 24V, 2.5A (full load)

Fig. 8-1 Efficiency vs. output current at 24V, typ.

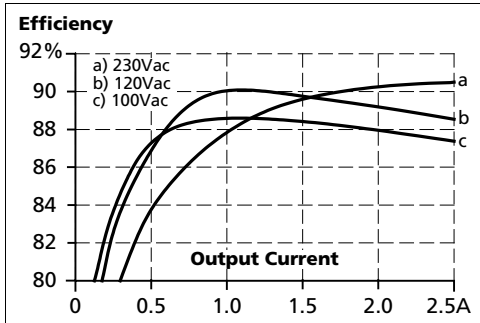

Fig. 8-2 Losses vs. output current at 24V, typ.

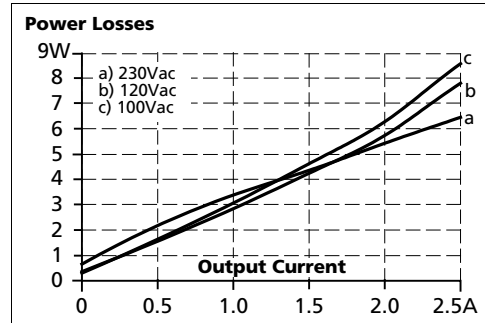

Fig. 8-3 Efficiency vs. input voltage at 24V, 2.5A, typ.

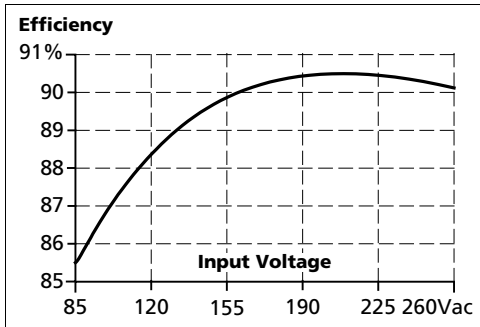
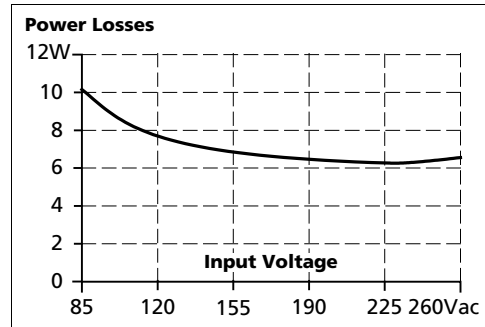
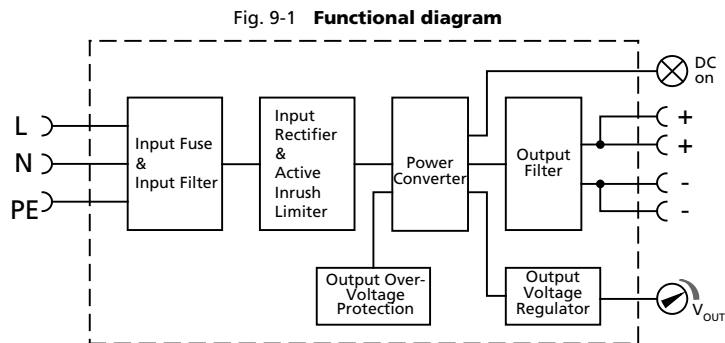

Fig. 8-4 Losses vs. input voltage at 24V, 2.5A, typ.



9. FUNCTIONAL DIAGRAM



10. FRONT SIDE AND USER ELEMENTS

Fig. 10-1 **Front side**

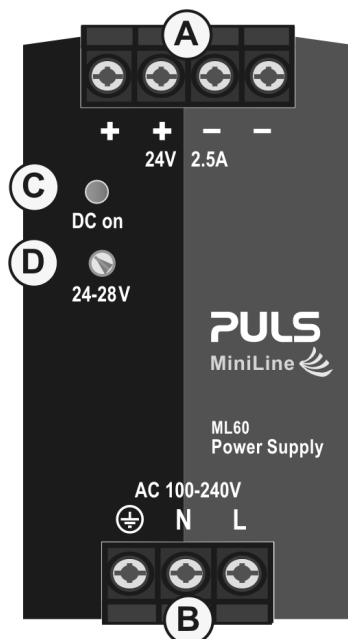

A Output Terminals

Screw terminals,
Dual terminals for the negative and positive pole. Both poles are equal
+ Positive output
- Negative (return) output

B Input Terminals

Screw terminals
L Phase (Line) input
N Neutral conductor input
⊕ PE (Protective Earth) input

C DC-on LED (green)

On, when the voltage on the output terminals is > 17V

D Output voltage potentiometer

(single turn potentiometer)
Turn to set the output voltage. Factory set: 24.5V

11. TERMINALS AND WIRING

All terminals are easy to access when mounted on the panel. Input and output terminals are separated from each other (input below, output above) to help in error-free wiring.

	Input	Output
Type	screw terminals	screw terminals
Solid wire	max. 6mm ²	max. 6mm ²
Stranded wire	max. 4mm ²	max. 4mm ²
American Wire Gauge	max. AWG10	max. AWG10
Wire stripping length	7mm / 0.275inch	7mm / 0.275inch
Screwdriver	3.5mm slotted or Pozidrive No 2	3.5mm slotted or Pozidrive No 2
Recommended tightening torque	1Nm, 9lb.in	1Nm, 9lb.in

Instructions:

- Use appropriate copper cables that are designed for an operating temperature of: 60°C for ambient up to 45°C and 75°C for ambient up to 60°C minimum.
- Follow national installation codes and installation regulations!
- Ensure that all strands of a stranded wire enter the terminal connection!
- Up to two stranded wires with the same cross section are permitted in one connection point (except PE wire).
- Do not use the unit without PE connection.
- Screws of unused terminal compartments should be securely tightened.
- Ferrules are allowed.
- Do not connect or disconnect the wires from the terminals below -25°C (-13°F).

12. LIFETIME EXPECTANCY AND MTBF

These units are extremely reliable and use only the highest quality materials. The number of critical components such as electrolytic capacitors has been reduced.

	AC 100V	AC 120V	AC 230V	
Lifetime expectancy *)	50 000h	66 000h	90 000h	at 24V, 2.5A and 40°C
	122 000h	132 000h	104 000h	at 24V, 1.25A and 40°C
	142 000h *)	188 000h *)	255 000h *)	at 24V, 2.5A and 25°C
MTBF **) SN 29500, IEC 61709	1 292 000h	1 565 000h	1 866 000h	at 24V, 2.5A and 40°C
	2 343 000h	2 753 000h	3 216 000h	at 24V, 2.5A and 25°C
MTBF **) MIL HDBK 217F	772 000h	841 000h	861 000h	at 24V, 2.5A, 40°C; Ground Benign GB40
	1 029 000h	1 127 000h	1 167 000h	at 24V, 2.5A, 25°C; Ground Benign GB25
	176 000h	196 000h	213 000h	at 24V, 2.5A, 40°C; Ground Fixed GF40
	229 000h	256 000h	281 000h	at 24V, 2.5A, 25°C; Ground Fixed GF25

*) The **Lifetime expectancy** shown in the table indicates the minimum operating hours (service life) and is determined by the lifetime expectancy of the built-in electrolytic capacitors. Lifetime expectancy is specified in operational hours and is calculated according to the capacitor's manufacturer specification. The manufacturer of the electrolytic capacitors only guarantees a maximum life of up to 15 years (131 400h). Any number exceeding this value is a calculated theoretical lifetime which can be used to compare devices.

) **MTBF stands for **Mean Time Between Failure**, which is calculated according to statistical device failures, and indicates reliability of a device. It is the statistical representation of the likelihood of a unit to fail and does not necessarily represent the life of a product. The MTBF figure is a statistical representation of the likelihood of a device to fail. A MTBF figure of e.g. 1 000 000h means that statistically one unit will fail every 100 hours if 10 000 units are installed in the field. However, it can not be determined if the failed unit has been running for 50 000h or only for 100h.

13. EMC

The power supply is suitable for applications in industrial environment as well as in residential, commercial and light industry environment without any restrictions. A detailed EMC report is available on request.

EMC Immunity	Generic standards: EN 61000-6-1 and EN 61000-6-2			
Electrostatic discharge	EN 61000-4-2	Contact discharge	8kV	Criterion A
		Air discharge	8kV	Criterion A
Electromagnetic RF field	EN 61000-4-3	80MHz-2.7GHz	20V/m	Criterion A
Fast transients (Burst)	EN 61000-4-4	Input lines	4kV	Criterion A
		Output lines	2kV	Criterion A
Surge voltage on input	EN 61000-4-5	L → N	2kV	Criterion A
		N → PE, L → PE	4kV	Criterion A
Surge voltage on output	EN 61000-4-5	+ → -	1kV	Criterion A
		+ → PE, - → PE	2kV	Criterion A
Conducted disturbance	EN 61000-4-6	0.15-80MHz	20V	Criterion A
Mains voltage dips	EN 61000-4-11	0% of 100Vac	0Vac, 20ms	Criterion A *)
		40% of 100Vac	40Vac, 200ms	Criterion C
		70% of 100Vac	70Vac, 500ms	Criterion A
		0% of 200Vac	0Vac, 20ms	Criterion A
		40% of 200Vac	80Vac, 200ms	Criterion A
		70% of 200Vac	140Vac, 500ms	Criterion A
Voltage interruptions	EN 61000-4-11		0Vac, 5000ms	Criterion C
Input voltage swells	PULS internal standard		300Vac, 500ms	Criterion A
Powerful transients	VDE 0160	over entire load range	750V, 1.3ms	Criterion A

Criteria:

A: Power supply shows normal operation behavior within the defined limits.

B: The power supply operates continuously during and after the test. During the test minor temporary impairments may occur, which will be corrected by the power supply itself.

C: Temporary loss of function is possible. Power supply may shut-down and restarts by itself. No damage or hazards for the power supply will occur.

*) Up to 1.8A output current criterion A, above 1.8A output current criterion B

EMC Emission	Generic standards: EN 61000-6-3 and EN 61000-6-4	
Conducted emission	EN 55011, EN 55032, FCC Part 15, CISPR 11, CISPR 32	Class B, input lines
Radiated emission	EN 55011, EN 55032, CISPR 11, CISPR 32	Class B
Harmonic input current	EN 61000-3-2	Not applicable below 75W input power Class A limits acc. to EN 61000-3-2 fulfilled.
Voltage fluctuations, flicker *)	EN 61000-3-3	Fulfilled

This device complies with FCC Part 15 rules.

Operation is subjected to following two conditions: (1) this device may not cause harmful interference, and (2) this device must accept any interference received, including interference that may cause undesired operation.

*) tested with constant current loads, non pulsing

Switching frequency

Converter frequency	variable, typ. 100kHz, min. 45kHz, max. 160kHz	Input voltage and output load dependent
---------------------	--	---

14. ENVIRONMENT

Operational temperature *)	-40°C to +70°C (-40°F to 158°F)	reduce output power according Fig. 14-1
Storage temperature	-40°C to +85°C (-40°F to 185°F)	for storage and transportation
Output de-rating	1.5W/°C	60-70°C (140°F to 158°F)
Humidity **)	5 to 95% r.H.	IEC 60068-2-30
Vibration sinusoidal	2-17.8Hz: ±1.6mm; 17.8-500Hz: 2g 2 hours / axis	IEC 60068-2-6
Shock	15g 6ms, 10g 11ms 3 bumps / direction, 18 bumps in total	IEC 60068-2-27
Altitude	0 to 2000m (0 to 6 560ft) 2000 to 6000m (6 560 to 20 000ft)	without any restrictions reduce output power or ambient temperature see Fig. 14-2 IEC 62103, EN 50178, overvoltage category II
Altitude de-rating	4W/1000m or 5°C/1000m	> 2000m (6500ft), see Fig. 14-2
Over-voltage category	III II	IEC 62103, EN 50178, altitudes up to 2000m altitudes from 2000m to 6000m
Degree of pollution	2	IEC 62103, EN 50178, not conductive

*) Operational temperature is the same as the ambient temperature and is defined as the air temperature 2cm below the unit.
Do not connect or disconnect the wires from the terminals below -25°C.

***) Do not energize while condensation is present

Fig. 14-1 Output power vs. ambient temp.

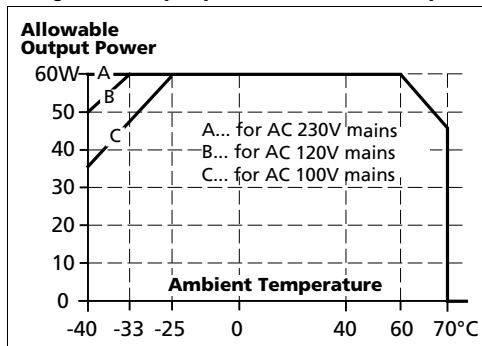
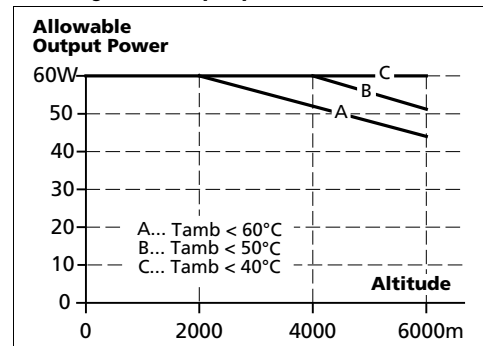

Fig. 14-2 Output power vs. altitude



15. PROTECTION FEATURES

Output protection	Electronically protected against overload, no-load and short-circuits *)	
Output over-voltage protection	typ. 31Vdc max. 32.5Vdc	In case of an internal power supply fault, a redundant circuit limits the maximum output voltage. In such a case, the output shuts down and stays down until the input voltage is turned off and on again.
Output over-current protection	electronically limited	see Fig. 5-1
Degree of protection	IP 20	EN/IEC 60529
Penetration protection	> 2.5mm in diameter	e.g. screws, small parts
Over-temperature protection	Not included	
Input transient protection	MOV	Metal Oxide Varistor
Internal input fuse	T3.15A H.B.C.	not user replaceable

*) In case of a protection event, audible noise may occur.

16. SAFETY FEATURES

Input / output separation *)	SELV PELV	IEC/EN 60950-1 IEC/EN 60204-1, EN 50178, IEC 62103, IEC 60364-4-41
Class of protection	I II (with restrictions)	PE (Protective Earth) connection required for use without PE connection contact PULS
Isolation resistance	> 5M Ω	Input to output, 500Vdc
Touch current (leakage current)	typ. 0.13mA / 0.29mA typ. 0.19mA / 0.40mA typ. 0.30mA / 0.63mA < 0.17mA / 0.38mA < 0.25mA / 0.53mA < 0.41mA / 0.85mA	100Vac, 50Hz, TN-,TT-mains / IT-mains 120Vac, 60Hz, TN-,TT-mains / IT-mains 230Vac, 50Hz, TN-,TT-mains / IT-mains 110Vac, 50Hz, TN-,TT-mains / IT-mains 132Vac, 60Hz, TN-,TT-mains / IT-mains 264Vac, 50Hz, TN-,TT-mains / IT-mains

*) Double or reinforced insulation

17. DIELECTRIC STRENGTH

The output voltage is floating and has no ohmic connection to the ground. Type and factory tests are conducted by the manufacturer. Field tests may be conducted in the field using the appropriate test equipment which applies the voltage with a slow ramp (2s up and 2s down). Connect all phase-terminals together as well as all output poles before conducting the test. When testing, set the cut-off current settings to the value in the table below.



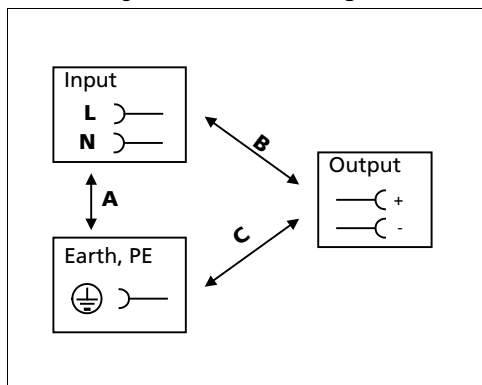





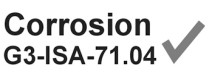

Fig. 17-1 Dielectric strength



		A	B	C
Type test	60s	2500Vac	4000Vac	2000Vac
Factory test	5s	2500Vac	2500Vac	500Vac
Field test	5s	2000Vac	2000Vac	500Vac
Cut-off current setting		> 4mA	> 4mA	> 1mA at 500V > 4mA at 2000V

To fulfill the PELV requirements according to EN 60204-1 § 6.4.1, we recommend that either the + pole, the – pole or any other part of the output circuit shall be connected to the protective earth system. This helps to avoid situations in which a load starts unexpectedly or can not be switched off when unnoticed earth faults occur.

18. APPROVALS AND FULFILLED STANDARD

UL 508		UL Certificate Listed equipment for category NMTR - Industrial Control Equipment Applicable for US and Canada E-File: E198865
IEC 60950-1		CB Scheme Certificate General safety requirements for Information Technology Equipment (ITE)
UL 60950-1		UL Certificate Recognized component for category QQQQ - Information Technology Equipment (ITE) Applicable for US and Canada E-File: E137006
Class I Div 2		CSA Certificate Power Supplies for Hazardous Location Applicable for Canada and US CSA Class: 5318-01 (Canada), 5318-81 (USA) Temperature Code: T4 Groups: A, B, C and D
Marine (DNV GL)	 dnvgl.com/af	DNV-GL Certificate DNV-GL Type approved product Certificate: 12508-10HH Temperature: Class B Humidity: Class B Vibration: Class C EMC: Class A Enclosure: Class A
Marine (ABS)		ABS Design Assessment Certificate ABS (American Bureau of Shipment) assessed product Certificate: 17-HG1599236-PD
NEC Class 2		Manufacturer's Declaration NEC CLASS 2 - Limited Power Source Listed device according to NEC Handbook chapter 725-121
IEC 60068-2-60		Manufacturer's Declaration (Online Document) Environmental Tests, Flowing Mixed Gas Corrosion Test Test Ke - Method 4 H2S: 10ppb NO2: 200ppb Cl2: 10ppb SO2: 200ppb Test Duration: 3 weeks, which simulates a service life of at least 10 years.
ISA-71.04-1985		Manufacturer's Declaration (Online Document) Airborne Contaminants Corrosion Test Severity Level: G3 Harsh H2S: 100ppb NOx: 1250ppb Cl2: 20ppb SO2: 300ppb Test Duration: 3 weeks, which simulates a service life of at least 10 years
VDMA 24364	 VDMA 24364-C1-L/W	Paint Wetting Impairment Substances Test (or LABS-Test) Tested for Zone 2 and test class C1 according to VDMA 24364-C1-L/W for solvents and water-based paints

19. REGULATORY COMPLIANCE

EU Declaration of Conformity



The CE mark indicates conformance with the
- EMC directive
- Low-voltage directive
- RoHS directive

REACH Directive



Manufacturer's Statement
EU-Directive regarding the Registration, Evaluation,
Authorisation and Restriction of Chemicals

EAC TR Registration



EAC Certificate
EAC EurAsian Conformity - Registration Russia, Kazakhstan
and Belarus
8504408200, 8504409000

20. PHYSICAL DIMENSIONS AND WEIGHT

Weight	250g / 0.55lb
DIN-Rail	Use 35mm DIN-rails according to EN 60715 or EN 50022 with a height of 7.5 or 15mm. The DIN-rail height must be added to the unit depth (91mm) to calculate the total required installation depth.
Installation Clearances	See chapter 2

Fig. 20-1 Front view

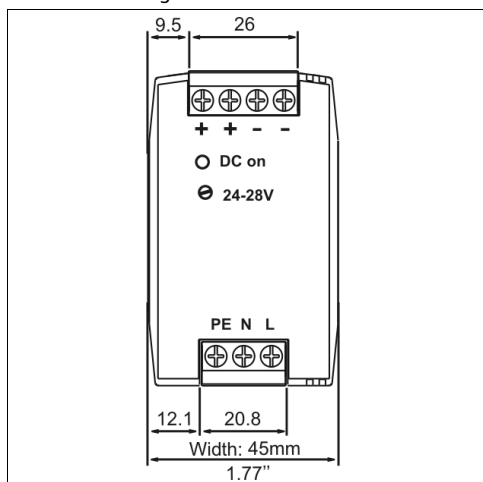
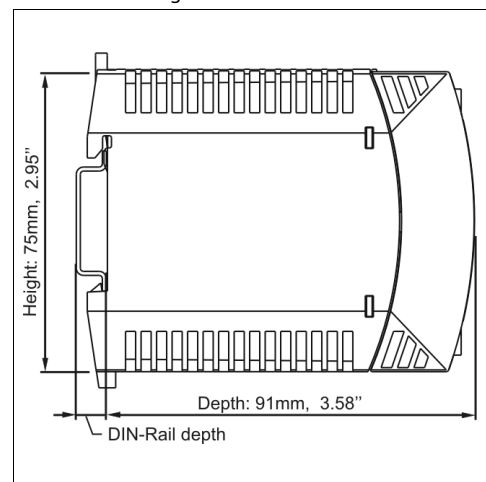

Fig. 20-2 Side view



21. ACCESSORY

21.1. ZM3.WALL – WALL MOUNT BRACKET

DIN-Rail bracket for wall or panel mount:

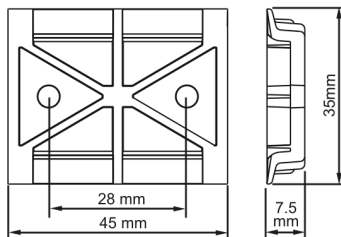

The picture of the power supply is for representation only

Hole diameter: 4.2mm

21.2. MLY10.241 - REDUNDANCY MODULE



The MLY10.241 is a dual redundancy module, which has two diodes with a common cathode included. It can be used for various purposes. The most popular application is to configure highly reliable and true redundant power supply systems. Another interesting application is the separation of sensitive loads from non-sensitive loads. This avoids the distortion of the power quality for the sensitive loads which can cause controller failures.

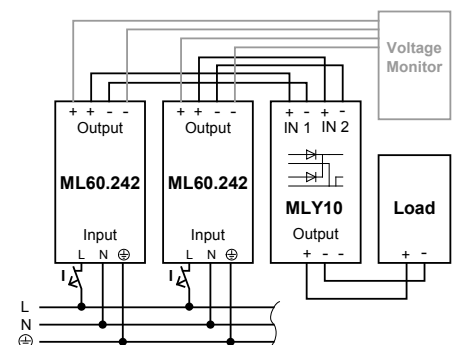

21.3. UF20.241 - BUFFER MODULE

This buffer unit is a supplementary device for DC 24V power supplies. It delivers power to bridge typical mains failures or extends the hold-up time after turn-off of the AC power. In times when the power supply provides sufficient voltages, the buffer module stores energy in integrated electrolytic capacitors. In case of mains voltage fault, this energy is released again in a regulated process. One buffer module can deliver 20A which can also be used to support peak current demands.



The buffer unit does not require any control wiring. It can be added in parallel to the load circuit at any given point. Buffer units can be added in parallel to increase the output ampacity or the hold-up time.

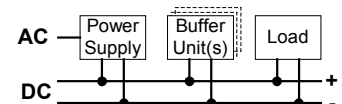

22. APPLICATION NOTES

22.1. PEAK CURRENT CAPABILITY

Solenoids, contactors and pneumatic modules often have a steady state coil and a pick-up coil. The inrush current demand of the pick-up coil is several times higher than the steady-state current and usually exceeds the nominal output current. The same situation applies when starting a motor or switching-on a capacitive load.

In many cases, the peak current capability also ensures a safe operation of subsequent circuit breakers. Branch circuits are often protected with circuit breakers or fuses. In case of a short or an overload in a branch circuit, the fuse needs a certain amount of over-current to trip or to blow.

Assuming the input voltage is turned on before such an event, the built-in large sized output capacitors inside the power supply can deliver extra current. Discharging this capacitor causes a voltage dip on the output. The following two examples show typical voltage dips:

Fig. 22-1 **Peak loading with 2x the nominal current for 50ms, typ.**

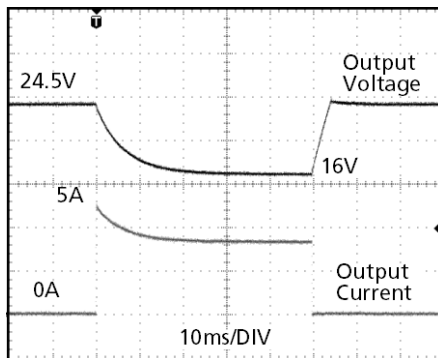

Peak load 5A (resistive load) for 50ms
Output voltage dips from 24V to 16V.

Fig. 22-2 **Peak loading with 5x the nominal current for 5ms, typ.**

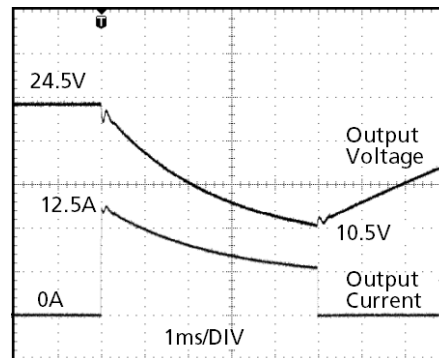

Peak load 12.5A (resistive load) for 5ms
Output voltage dips from 24V to 10.5V.

22.2. BACK-FEEDING LOADS

Loads such as decelerating motors and inductors can feed voltage back to the power supply. This feature is also called return voltage immunity or resistance against Back- E.M.F. (Electro Magnetic Force).

This power supply is resistant and does not show malfunctioning when a load feeds back voltage to the power supply. It does not matter whether the power supply is on or off.

The maximum allowed feed-back-voltage is 35Vdc. The absorbing energy can be calculated according to the built-in large sized output capacitor which is specified in chapter 5.

22.3. CHARGING OF BATTERIES

The power supply can be used to charge lead-acid or maintenance free batteries. (Two 12V batteries in series)

Instructions for charging batteries (float charging):

- Ensure that the ambient temperature of the power supply is below 45°C
- Set output voltage (measured at no load and at the battery end of the cable) very precisely to the end-of-charge voltage.

End-of-charge voltage	27.8V	27.5V	27.15V	26.8V
Battery temperature	10°C	20°C	30°C	40°C

- Use a 4A circuit breaker (or blocking diode) between the power supply and the battery.
- Ensure that the output current of the power supply is below the allowed charging current of the battery.
- Use only matched batteries when putting 12V types in series.
- The return current to the power supply (battery discharge current) is typical 7.3mA when the power supply is switched off (except in case a blocking diode is utilized).

22.4. EXTERNAL INPUT PROTECTION

The unit is tested and approved for branch circuits up to 20A. An external protection is only required, if the supplying branch has an ampacity greater than this. Check also local codes and local requirements. In some countries local regulations might apply.

If an external fuse is necessary or utilized, minimum requirements need to be considered to avoid nuisance tripping of the circuit breaker. A minimum value of 6A B- or 3A C-Characteristic breaker should be used.

22.5. PARALLEL USE TO INCREASE OUTPUT POWER

ML60.242 power supplies can be paralleled to increase the output power. This power supply has no feature included which balances the load current between the power supplies. Usually the power supply with the higher adjusted output voltage draws current until it goes into current limitation. This means no harm to this power supply as long as the ambient temperature stays below 45°C. The ML60.242 can also be paralleled with other power supplies from MiniLine series with 24V output voltage. The output voltages of all power supplies shall be adjusted to the same value ($\pm 100\text{mV}$). A fuse or diode on the output of each unit is only required if more than three units are connected in parallel. If a fuse (or circuit breaker) is used, choose one with approximately 150% of the rated output current of one power supply. Keep an installation clearance of 15mm (left / right) between two power supplies and avoid installing the power supplies on top of each other. Do not use power supplies in parallel in mounting orientations other than the standard mounting orientation (input terminals on the bottom and output terminals on top of the unit). Be aware that leakage current, EMI, inrush current and harmonics will increase when using multiple power supplies in parallel.

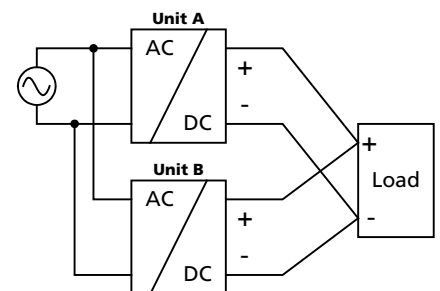

22.6. PARALLEL USE FOR REDUNDANCY

Power supplies can be paralleled for redundancy to gain higher system availability. Redundant systems require a certain amount of extra power to support the load in case one power supply unit fails. The simplest way is to put two power supplies in parallel. This is called a 1+1 redundancy. In case one power supply unit fails, the other one is automatically able to support the load current without any interruption. Redundant systems for a higher power demand are usually built in a N+1 method. E.g. five power supplies, each rated for 2.5A are paralleled to build a 10A redundant system.

Please note: This simple way to build a redundant system does not cover failures such as an internal short circuit in the secondary side of the power supply. In such a case, the defect unit becomes a load for the other power supplies and the output voltage can not be maintained any more. This can only be avoided by utilizing decoupling diodes which are included in the redundancy module MLY10.241.

Recommendations for building redundant power systems:

- Use separate input fuses for each power supply.
- Use separate mains systems for each power supply whenever it is possible.
- Monitor the individual power supply units.
- 1+1 Redundancy is allowed up to an ambient temperature of 60°C.
N+1 Redundancy is allowed up to an ambient temperature of 45°C.
- It is desirable to set the output voltages of all units to the same value ($\pm 100\text{mV}$) or leave it at the factory setting.

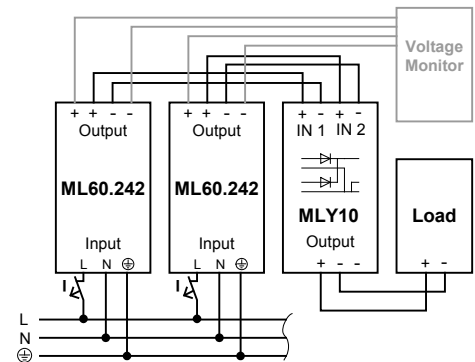

22.7. DAISY CHAINING OF OUTPUTS

Daisy chaining (jumping from one power supply output to the next) is allowed as long as the average output current through one terminal pin does not exceed 25A. If the current is higher, use a separate distribution terminal block.

Fig. 22-3 Daisy chaining of outputs

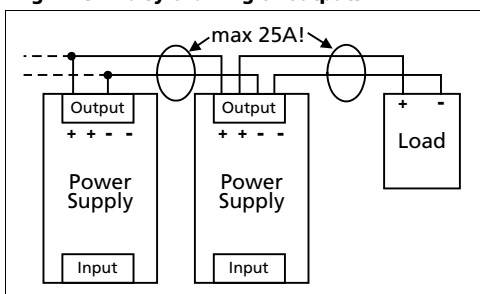
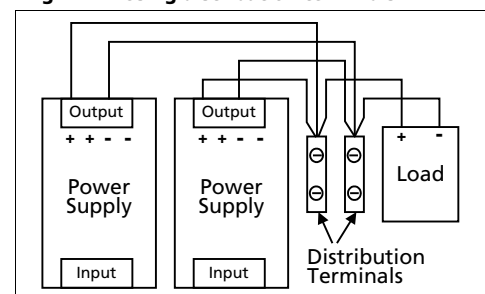

Fig. 22-4 Using distribution terminals



22.8. INDUCTIVE AND CAPACITIVE LOADS

The unit is designed to supply any type of load, including unlimited capacitive and inductive loads.

22.9. SERIES OPERATION

Power supplies of the exact same type can be connected in series for higher output voltages. It is possible to connect as many units in series as needed, providing the sum of the output voltage does not exceed 150Vdc. Voltages with a potential above 60Vdc are not SELV any more and can be dangerous. Such voltages must be installed with a protection against touching. Earthing of the output is required when the sum of the output voltage is above 60Vdc. Avoid return voltage (e.g. from a decelerating motor or battery) which is applied to the output terminals. Keep an installation clearance of 15mm (left / right) between two power supplies and avoid installing the power supplies on top of each other. Do not use power supplies in series in mounting orientations other than the standard mounting orientation (input terminals on the bottom and output terminals on top of the unit). Be aware that leakage current, EMI, inrush current and harmonics will increase when using multiple power supplies in series.

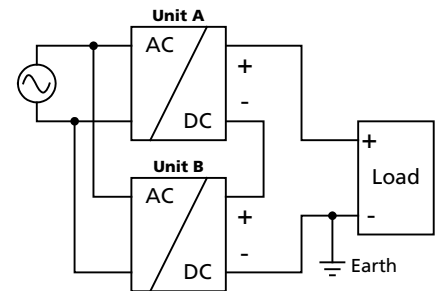

22.10. OPERATION ON TWO PHASES

The power supply can also be used on two-phases of a three-phase-system. A phase-to-phase connection is allowed as long as the supplying voltage is below $240V^{+10\%}$. Use a fuse or a circuit breaker to protect the N input. The N input is not internally protected and is in this case connected to a hot wire. Appropriate fuses or circuit breakers are specified in section 22.4 "External Input Protection".

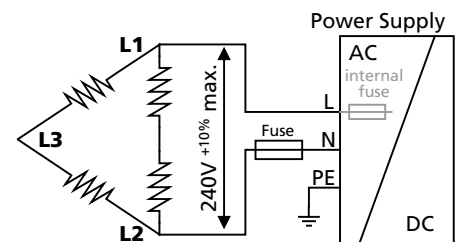

22.11. USE WITHOUT PE ON THE INPUT

From a safety standpoint, the unit is internally designed according to the requirements for Protection Class 1 and 2. Please contact PULS if you do not plan to use the PE terminal. A different marking of the front foil is then required. Grounding of the input is beneficial for a high EMI immunity: Symmetrical spikes or fast transients on the input side can be conducted directly to earth by the built-in filter capacitors. The magnitude of such spikes or fast transients on the output side caused by the input is much smaller compared to not connecting this terminal to ground.

Fig. 22-5 Earthed input

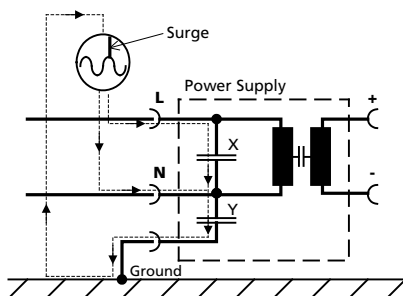
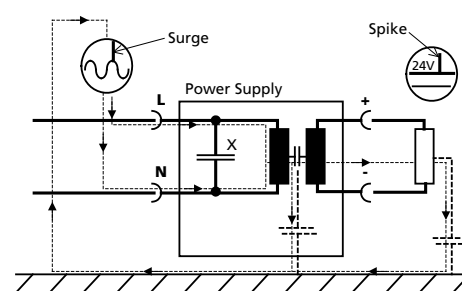

Fig. 22-6 Not earthed input



22.12. USE AT LOW TEMPERATURES (-25°C / -40°C)

Please pay attention to the following aspects when operating the unit at low temperatures. Perform tests to verify suitability in your application.

- The ripple & noise voltage will increase. For the first minutes after turning on the unit at -40°C, the ripple and noise voltage can be up to typically 400mVpp depending on load and input voltage. Once the unit heats up, the ripple & noise voltage will decrease typically to 90mVpp.
- The start-up delay can be up to 5 seconds. It is a continuous turn-on process without any voltage dips or start-up attempts.

22.13. USE IN A TIGHTLY SEALED ENCLOSURE

When the power supply is installed in a tightly sealed enclosure, the temperature inside the enclosure will be higher than outside. In such situations, the inside temperature defines the ambient temperature for the power supply.

The following measurement results can be used as a reference to estimate the temperature rise inside the enclosure.

The power supply is placed in the middle of the box; no other heat producing items are inside the box.

Enclosure: Rittal Type IP66 Box PK 9510 100, plastic, 130x130x75mm
Input: 230Vac

Case A:

Load: 24V, 2.5A; load is placed outside the box
Temperature inside the box: 40.3°C (in the middle of the right side of the power supply with a distance of 1cm)
Temperature outside the box: 21.8°C
Temperature rise: 18.5K

Case B:

Load: 24V, 2.0A; (=80%) load is placed outside the box
Temperature inside the box: 38.6°C (in the middle of the right side of the power supply with a distance of 1cm)
Temperature outside the box: 22.1°C
Temperature rise: 16.5K

22.14. MOUNTING ORIENTATIONS

Mounting orientations other than input terminals on the bottom and output on the top require a reduction in continuous output power or a limitation in the maximum allowed ambient temperature. The amount of reduction influences the lifetime expectancy of the power supply. Therefore, two different derating curves for continuous operation can be found below:

Curve A1 Recommended output current.

Curve A2 Max allowed output current (results in approximately half the lifetime expectancy of A1).

Fig. 22-7
Mounting Orientation A
(Standard orientation)

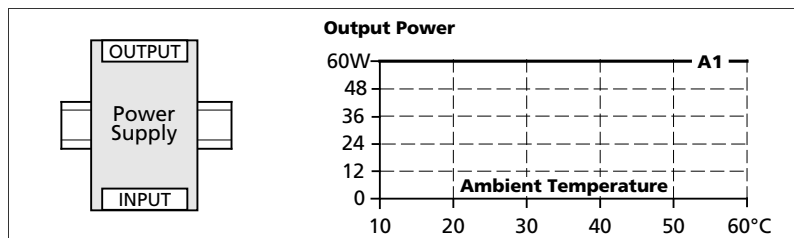

Fig. 22-8
Mounting Orientation B
(Upside down)

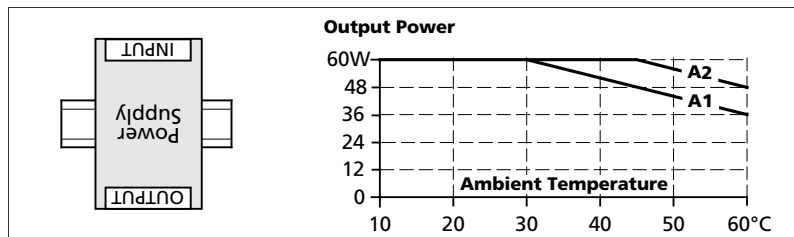

Fig. 22-9
Mounting Orientation C
(Table-top mounting)

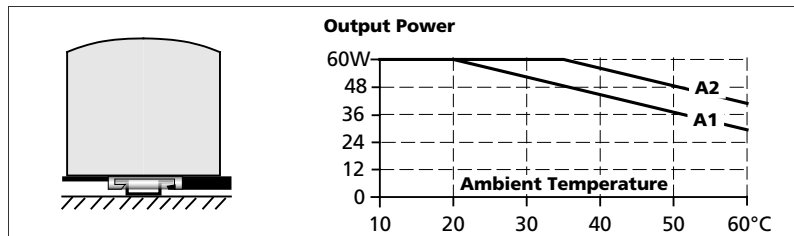

Fig. 22-10
Mounting Orientation D
(Horizontal cw)

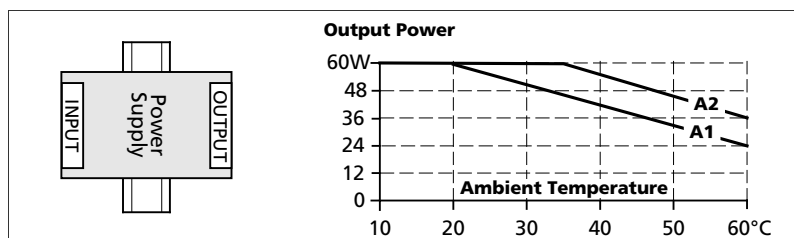

Fig. 22-11
Mounting Orientation E
(Horizontal ccw)

