

10 A 3-phase SL10.300 SL10.309 (Conformal Coated)

- Input: 3 AC 400-500V (2-phase and 3-phase operation)
- Output: 24-28V / 240W
- Power Boost up to 288W
- External primary fuse not necessary
- Switchable operating mode (single/parallel)
- Switchable overload behaviour options (Fuse Mode / Continuous Mode)



This compact power supply unit is characterised by the variety of possibilities of application and low system costs. The fact that the **external fuses are no longer necessary** is an advantage as it saves cost and space. The switchable **Fuse Mode**, the fully specified **2-phase operation** and the extremely comprehensive **approvals package** including EN60204 make the SL10.300 the unit of choice.

At a competitive price, it also offers **12A power boost**, 20A short circuit current, **output noise suppression**, optional Single Mode or Parallel Mode, small dimensions, more than **500,000h MTBF** as well as easy installation. The unit can be connected to European and American power supply networks **without switching**.

Input

Nominal input voltage 2 AC and 3 AC 400-500V
47...63Hz, suitable for IT power systems

- Rated tolerances (at 24V/10A) 2-phase and 3-phase operation
- Continuous operat. AC 340...576V resp. DC 450...820V
 - Short-term (1 min.) AC 300...620V resp. DC 400...890V
 - Pls. ask for 'application notes' at operation with DC input voltage.

2-phase operation is specified and permissible. Connection to 3 phases is recommended due to reduced component stress.

Internally fused on each phase. External fusing is only necessary as required for input line protection.

Input current 3 x 0.8/0.7A at AC 400/500V
(at 24V/10A) 2 x 1.2/1A at AC 400/500V

Inrush current (supply impedance acc. EN61000-3-3)

	AC 400V	AC 500V	AC 575V	DC 820V
Peak current	15.4A	15.4A	17.0A	17.9A
I^2t	<0.26A ² s	<0.44A ² s	<0.59A ² s	<0.72A ² s

EN 61000-3-2 (harmonic current emissions [PFC]) is fulfilled

Transient handling Transient resistance acc. to VDE 0160/W2 (1300V/1.3ms), for all load conditions

Emissions 3-phase and 2-phase operation: acc. to EN 61000-6-3 (Class B)

Hold-up time >24ms (3-phase operat. @ AC 400V, 24V/10A)
>20ms (2-phase operat. @ AC 400V, 24V/10A)

*For further information, particularly about

- EMC, Connections
- Safety, Approvals,
- Mechanics and Mounting: see data sheet „The SilverLine“ pg. 2
- Detailed dimensions: see SilverLine mechanics data sheet SL10.300

Output

Output voltage DC 24-28V, adjustable by (covered) front panel potentiometer, preset: 24.5V ±0.5%
Adjusting range guaranteed

Output noise suppression Conducted EMI values below EN61000-6-3, even when using long, unscreened output cables.

Ambient temperature range T_{amb} Operation: 0°C...+70°C (>60°C with Derating)
Storage: -25°C...+85°C

Derating 6W/K (at T_{amb} = +60°C...+70°C)

Rated continuous loading with convection cooling

- T_{amb} = 0°C - 60°C 24V/10A (240W) resp. 28V/8.6A (240W)
- T_{amb} = 0°C - 45°C 24V/12A (288W) resp. 28V/10.3A (288W)

Output is protected against short-circuit, open circuit and overload.

Voltage regulation <2% over all, jumper in 'Single Mode' position

Ripple/Noise <30mV_{pp} (20MHz bandwidth)

Overvolt. protection typ. 36V, max. 39V

Power back immunity min. 34V

Parallel operation Yes, up to five units.

To achieve current sharing:

- Plug jumper into pos. 'Output parallel use'. This alters the output V/I characteristic to be 'softer' (25V at 1A, 24V at 10A). The output voltage can still be adjusted.
- Missing jumper = 'Single Use', i.e. 'hard' characteristic

Front panel indicator:

- Green LED on, when V_{out} > 18V
- Red LED flashes after switch-off in the Fuse Mode

Construction / Mechanics*

Housing dimensions and Weight

- W x H x D 89mm x 124mm x 117mm (+ DIN rail)
- Free space for convection cooling above/below 50mm recommended
left/right 20mm recommended
- Weight 980g

Design advantages:

- All connection blocks are easy to reach as mounted on the front panel.
- PVC insulated cable can be used for all connections, as the connection blocks are mounted on the cooler area on the underside of the unit.

Order information

Order number

SL10.300/
SL10.309

Description

SLZ13 (adapter for S7-300 rail)
SLZ02 (wall mounting set; contains 2 pcs.)

Efficiency, Reliability etc.

Efficiency / Power loss:

3-phase operation	typ. 91.2% / $P_{loss} = 23.6W$ (400V)
	typ. 92% / $P_{loss} = 21.4W$ (500V)
2-phase operation	typ. 90.9% / $P_{loss} = 24.5W$ (400V)

MTBF acc. to Siemensnorm SN 29500 at 24V/10A, AC 400V, $T_{amb} = +40^{\circ}C$

3-phase operation	543.000h
2-phase operation	525.000h

Life cycle (electrolytics) The unit exclusively uses longlife electrolytics, specified for $+105^{\circ}C$

Start Behaviour

Startup delay	typ. 100ms
Rise time	appr. 5-20ms, depending on load

Overload Behaviour

Two different operating mode options, switchable by plugging the front-panel jumper. If the jumper is missing, the unit is in the Fuse Mode. The unit is delivered preset in Continuous Mode.

a) Continuous Mode (continuous current):

- Jumper is in the 'OVL cont. mode' position.
- When overload or short-circuit occurs, the unit continuously supplies current (see. diag. 1), no Hiccup.

Advantage: The unit starts reliably even with heavy, non-linear loads (high capacities, DC-DC converters, motors). The high short-circuit current triggers downstream fuses, and allows for selective configuration of electrical installations.

b) Fuse Mode (Switch-off after typ. 5s):

- Jumper is in the 'OVL fuse mode' position.
- When overload or short-circuit occurs for more than typ. 5s, the unit switches off the output.
- Definition of overload or short-circuit: The set output voltage in each case can no longer be maintained.
- The capacity to deliver current (PULS Overload Design™) (see diag. 1) remains unchanged during the typ. 5s delay time.
- **Red LED flashes** at switch-off.

Feature: With some applications, the Fuse Mode can replace the usual fusing on the secondary side. The Fuse Mode has closer tolerances than thermal trips. The release delay time of typ. 5s ensures that motors can be reliably operated.

Re-start:

- by pushing the reset button on the unit's front panel
- by disconnection from mains and re-start of the unit after > 1 min. or as soon as the red LED stops flashing

Overtemperature Protection

Continuous Mode	Switch-off and automatic re-start after cooling.
Fuse Mode	Unit remains switched off after overheating until restart (also see 'Re-start' above).

Functional diagrams

Output characteristic (min.)

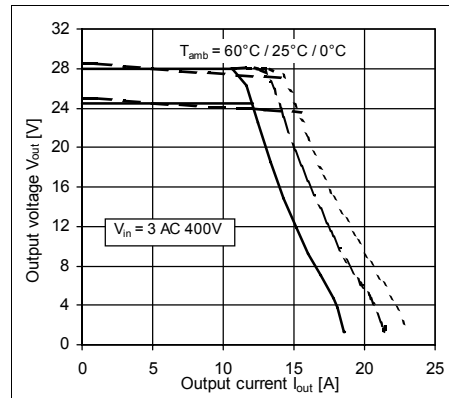

diag. 1

Efficiency (typ., @ $V_{out}=24.5V$)

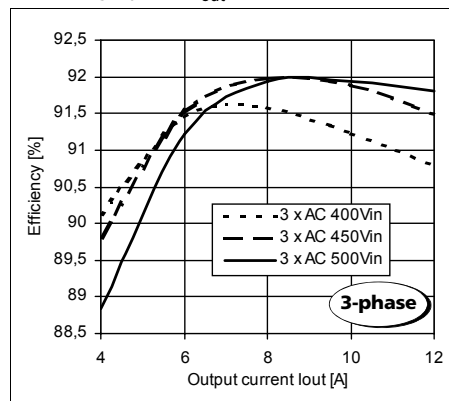

diag. 2

Hold-up time (typ., @ $V_{out}=24.5V$)

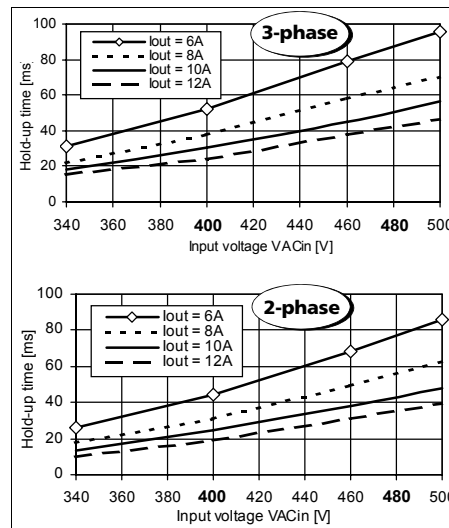

diag. 3

Unless otherwise stated, specifications are valid for AC 230V input voltage, $+25^{\circ}C$ ambient temperature, and 5 min. run-in time. They are subject to change without prior notice.

Your partner in power supply:



European Power Supply Manufacturers Association



Bayerns Best 50
Czech 100 Best
Europe's 500

PULS GmbH
 Arabellastraße 15
 D-81925 München
 Tel.: +49 89 9278-0
 Fax: +49 89 9278-199
 www.puls-power.com

SL10.300

- Innovative DIN-Rail mount, unit holds even at vibration or lateral pressure
- Clearly arranged and user oriented
- Large, robust screw terminals
- Sealed metal housing
- Fine ventilating grid

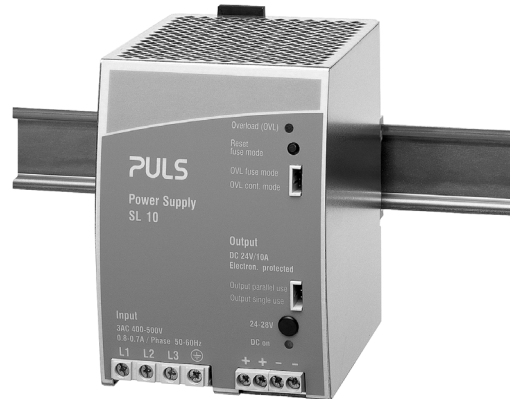
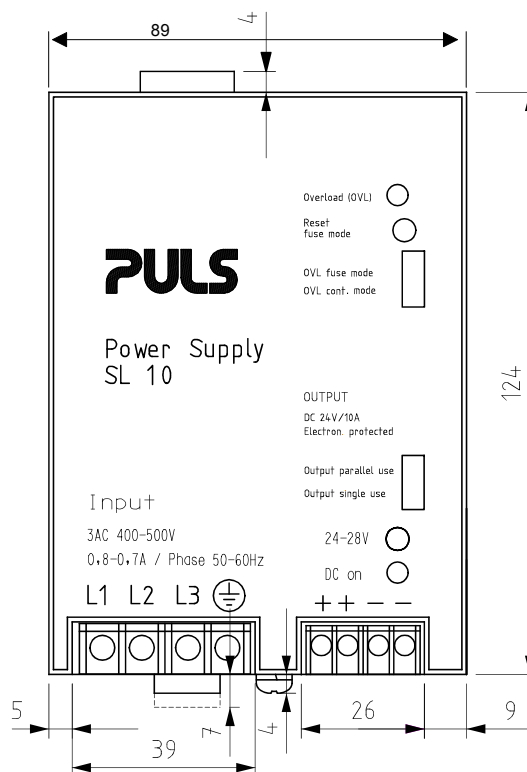
Front view
SL10.300

Construction / Mechanics

Housing dimensions and Weight

- W x H x D 89 mm x 124 mm x 117 mm (+ DIN rail)
- Free space for convection cooling above/below 25 mm recommended
- Weight 980 g

Robust metal housing with fine ventilat. grid (◇ 3,5 mm, IP20), to keep out small parts (e.g. screws)

- Mounting
- on DIN rail (TS35/7,5 or TS35/15, 1...1.5 mm thick), therefore
 - Simple snap-on system
 - Sits safely and firmly on the DIN-Rail
 - No tools required to remove
 - or backplane-mounted (two optional screw mounting sets SLZ01 required)

Connections

Connections

- Input/Output
- Current handling capacity
- Grid

Screw terminals, connector size range: solid 0.5- 6 mm² / flexible 0.5 - 4 mm²
 30 A per output
 Two connectors per output
 Primary side: 9,52 mm between adjacent connectors
 Secondary side: 6,35 mm between adjacent connectors

Design advantages:

- All connection blocks are easy to reach as mounted at the front panel. Input and output are strictly apart from each other and so cannot be mixed up
- PVC insulated cable can be used for all connections, no thermal protection is needed

Order information

Order number	Description
SL10.300	
SLZ01	Screw mounting set, two needed per unit

**Bottom view
SL10.300**

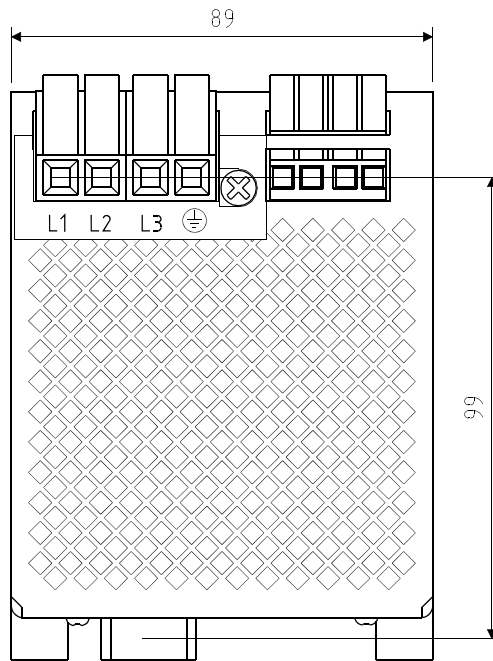

**Side view
SL10.300**

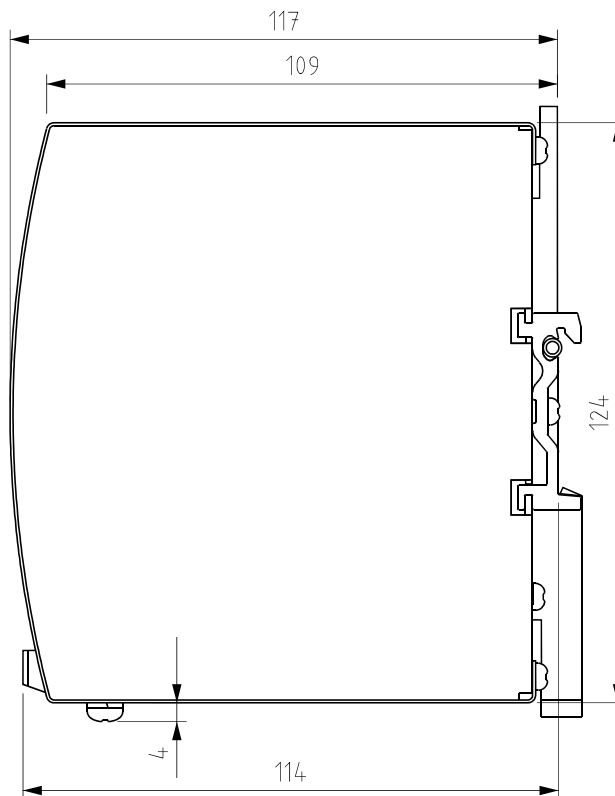

This 'mechanics data sheet' exclusively deals with the mechanical properties of the product. For further information (especially concerning electrical properties), please refer to the generic data sheet of the SL10.300 and to the basic data sheet „The SilverLine“ dealing with common features of all SilverLine units. This data sheet is subject to change without prior notice

Your partner in power supply:



Bayerns Best 50
Czech 100 Best
EuropeOs 500

PULS GmbH
 Arabellastraße 15
 D-81925 München
 Tel.: +49 89 9278-0
 Fax: +49 89 9278-199
 www.puls-power.com