

# AS-Interface Power Supply with 8A

## SLA8.100

**PULS**

Data sheet

- Input: AC 115V / 230V
- Output: 30.55V / 8A
- AS Interface data decoupling
- Infrared (IR) addressing mode
- Overload protection by FUSE Mode
- For highly demanding industrial applications

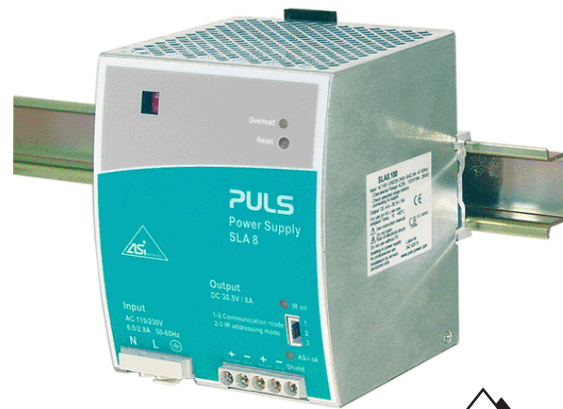

AS Interface  
Appr. No. 41601

### Short description

#### Data and energy:

The primary switched mode DIN rail power supply SLA8.100 specifically supplies AS Interface® systems with energy. The AS-Interface bus technology allows to connect up to 62 participants to a control and to supply them with energy with a single two-conductor cable. When connecting slaves, the yellow AS-Interface cable offers the high degree of protection IP67 in conjunction with the insulation displacement. The communication signals of the individual network participants are modulated onto the supply voltage. For this purpose, specific power supply units with integrated data decoupling are required for AS-Interface systems.

#### Fast addressing of slaves:

The "IR addressing mode" selectable via jumper interrupts the data communication on the yellow AS-Interface cable. Participants with an infrared interface can then quickly be assigned a new ID address by means of an infrared programming unit without the need to disconnect them from the AS-Interface cable. Afterwards, the "Communication Mode" can be selected again to re-start the data communication.

can be selected again to re-start the data communication.

#### Safe operation by FUSE Mode:

The device features a FUSE Mode, which permanently switches off the output in the event of failure and the unit at overload, short-circuit or overtemperature and thus protects the relatively thin AS-Interface line and the attached components. Triggering of the FUSE Mode is indicated by a flashing LED. System restart requires the intentional activation of a reset button on the front side of the unit. Thus, an accidental restart is prevented and the slaves are protected against damage.

#### Fit for the world market:

The input voltage range of the unit can be selected on the front panel. Thus, it can be operated worldwide on all usual single-phase line voltages. International (IEC 60950) and various national (CBscheme) approvals allow for worldwide application.

### Input

Rated voltage	AC 100-120/220-240V (selectable by front panel slide switch)			
Rated current	6.0A (switch in 115V position) 2.8A (switch in 230V position)			
Frequency	47...63 Hz (alternatively also DC possible)			
Voltage range	AC 85...132V/184...264V, DC 230...375V			
Power factor	>0.5			
Integrated internal fuse	T8A/250V HBC (ot accessible)			
Inrush current	Limited by NTC resistor (bypassed by a relay during normal operation) $T_{amb} = +50^{\circ}\text{C}$ , cold start (line impedance acc. EN 61000-3-3)			
Peak current $I_{pk}$	AC 100V	AC 120V	AC 220V	AC 240V
	<12A	<14A	<24A	<27A
$i^2t$	AC 100V	AC 120V	AC 220V	AC 240V
	<1.0A <sup>2</sup> s	<1.5A <sup>2</sup> s	<1.4A <sup>2</sup> s	<1.6A <sup>2</sup> s
Hold-up time	>10ms @ AC 100V or AC 196V and rated load (also see diagram)			

### Output

Rated voltage	DC 30.55V ±3% (not adjustable)	
Rated current	8.0A	
Isolation	Safe low voltage	PELV (IEC364-4-41) SELV (IEC60950)
Current limitation	>8.4A	
Overload behaviour	FUSE Mode (2...5s continuous current, afterwards permanent switch-off)	
Short-circuit current	>12A <25A (max. 5s)	
Load regulation	stat. <200mV (no load / full load)	
Line regulation	stat. <30mV (AC 85...132V/184...264V)	
Ripple	50mV <sub>pp</sub> (500kHz bandw., 50Ω measurement, ohmic load)	
Noise (Spikes)	100mV <sub>pp</sub> (20MHz bandw., 50Ω measurement, ohmic load)	
Overvoltage protection	limited to max. 55V	
Operating indicator	Green LED (extinguishes at overload)	
Output is protected against short-circuit, open circuit and overload.		
Use AS-Interface power supplies only together with AS-Interface lines!		

### Order information

#### Order number

SLA8.100  
SLZ13  
SLZ02

#### Description

AS-Interface power supply unit  
Adapter for S7-300 rail  
Wall mounting set (two pcs. per package)

**FUSE Mode**

The FUSE Mode (electronic fuse in the output) protects the unit from overload and overtemperature.

**Shutdown:**

- At overtemperature, overload or short-circuit ( $8.4A < I_{max} < 12A$ ), the unit switches off the output after 2...5s

**Indicator:**

- Activation of the FUSE Mode is indicated by a flashing red LED

**Reset / Restart:**

- by intentionally pushing the Reset button on the unit front panel
- by turning off the mains voltage. Before restarting the unit, wait at least twice the time the flashing red LED needed to extinguish after the mains voltage dropped.

**Operating and environmental data**

Non-operating temperature range	-25°C...+85°C
Operating temperature range	-10°C...+70°C (measured at 25mm below the unit)
Derating	from 60°C 6W/°C onwards, power reduction necessary (see diagram)
Cooling	natural convection, no forced air-cooling necessary
Over-temperature protection	implemented
Humidity	protect from moisture and condensation
Vibration	2 – 17.8Hz ±1.6cm
• Sinus	17.8Hz – 500Hz 2g (IEC 68-2-6)
• Random	2...800Hz 0.5m <sup>2</sup> (s <sup>3</sup> ) (IEC 68-2-64)
Shock	15g (6ms), 10g (11ms), (IEC 68-2-27)
Degree of pollution	2 (EN 60950)
Overvoltage category	III (EN 50178)

**Electromagnetic Compatibility (EMC)**

Emissions	EN 50081-2 Class B (EN 55011, EN 55022)
Immunity	EN 61000-6-2 (also includes EN 55024)
• Electrostatic Discharge (ESD)	EN 61000-4-2, Level 4 (withstands 8kV direct discharge, 15kV air discharge)
• Electromagnetic radiated fields	EN 61000-4-3, Level 3 (10V/m) ENV 50204 (10V/m)
• Burst, coupled to:	EN 61000-4-4,
– ACin lines	Level 4 (4 kV)
– DCout lines	Level 3 (2 kV)
• Surge transients	EN 61000-4-5,
– Differential mode (L→PE)	Installation class 4 (4kV)
– Common mode (L→ N)	Installation class 4 (2kV)
• Conducted noise immunity	EN 61000-4-6, Level 3 (10V, 150kHz - 80MHz)
• Voltage dips	EN 61000-4-11
• Transient immunity	Transient resistance acc. to VDE 0160 / W1 across entire load range

**Efficiency, Reliability**

Efficiency	typ. 92%	(AC 230V, 8A)
Power dissipation	typ. 21.2W	(AC 230V, 8A)

**Schematic**

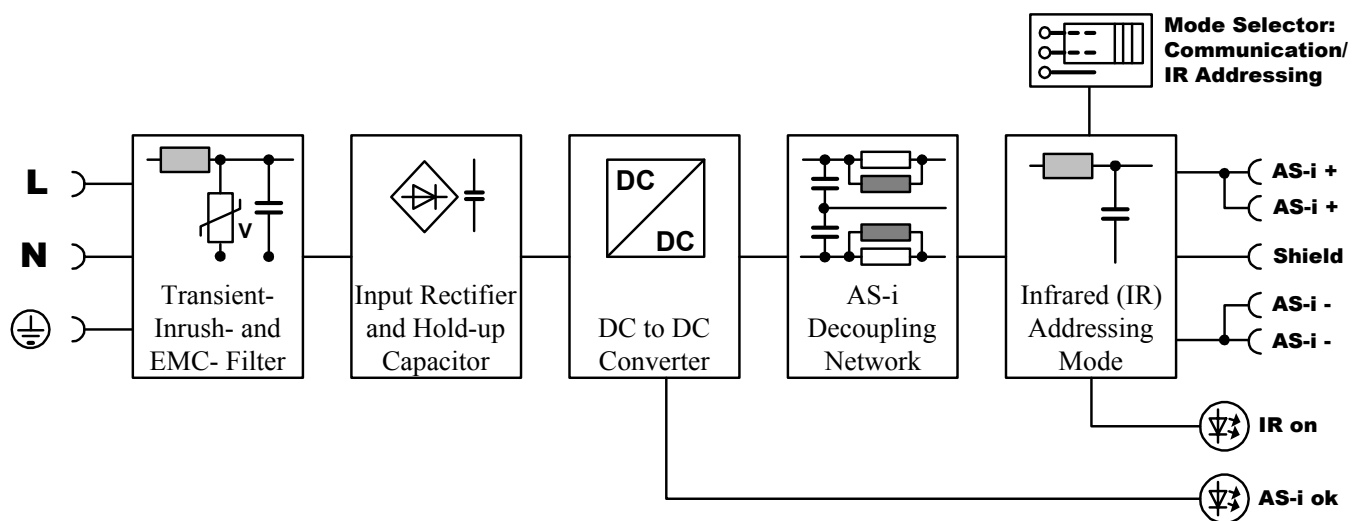

Operating indicators and elements

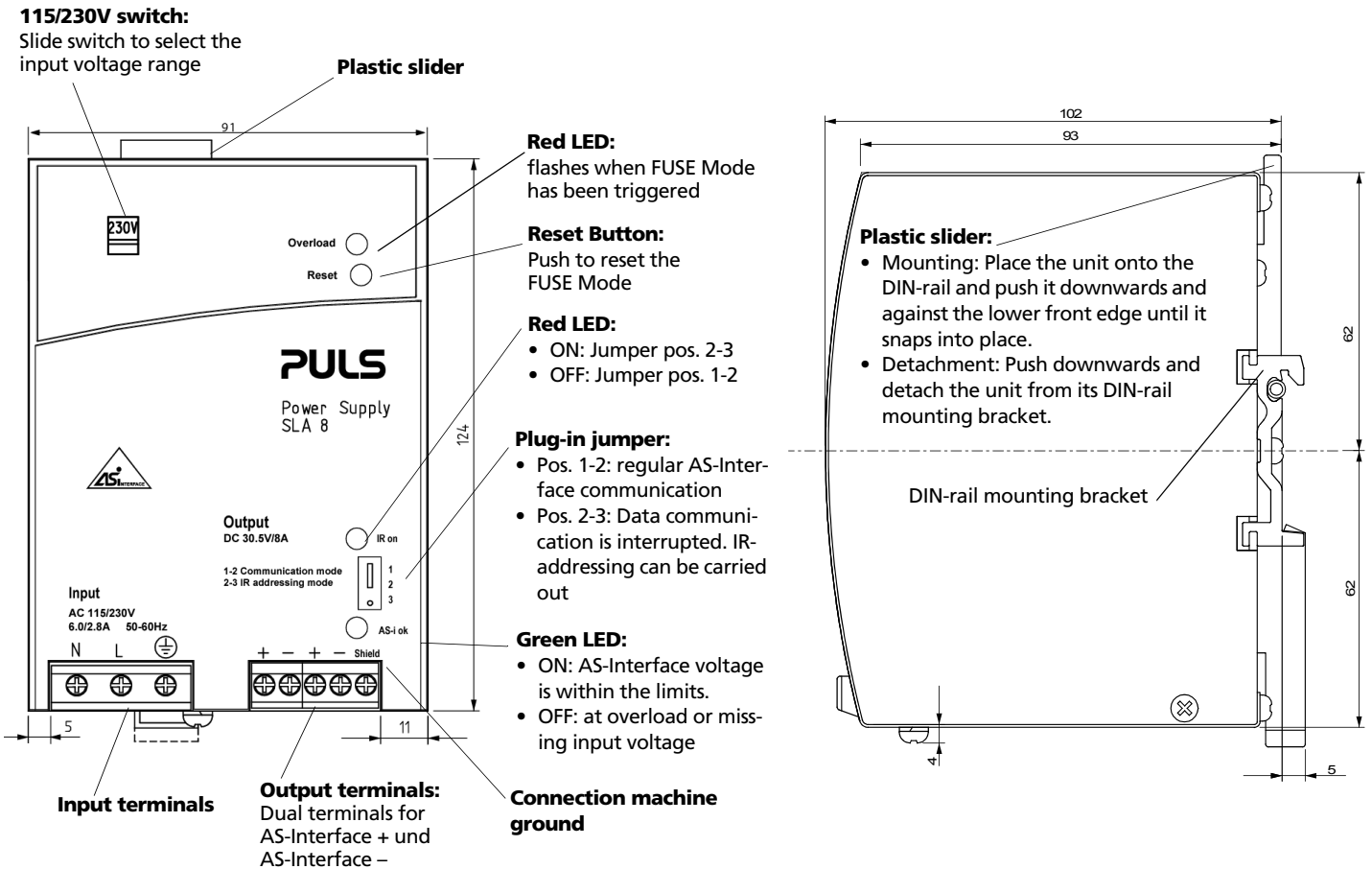

Connectors and terminals

Terminals	Fingertouch-proof terminals with captive screws for 5.5mm slotted screwdriver or Philips cross-recessed screwdriver No. 2
Position	Easy to reach terminals on the front panel; input and output clearly separate from each other
Tightening torque	0.8Nm
Connector size range	
• flexible cable	0.5-4mm <sup>2</sup> (20-10AWG)
• solid cable	0.5-6mm <sup>2</sup> (20-10AWG)
Ferrules	admissible
Stripping length	7mm

Front elements

⊕	PE terminal
N	Input neutral
L	Input phase
⊕ brown	Positive AS-Interface output voltage (twice)
⊖ blue	Negative AS-Interface output voltage (twice)
Shield	Connection of machine ground. (Functional earth for balancing the AS-Interface output. Connection is recommended for EMC)

Construction / Mechanics

Housing	Robust metal housing for built-in installation
Degree of protection	IP20 (EN 60529)
Class of protection	1 (IEC536); do not use without protective earth (PE)
Width w	91mm
Height h	124mm
Depth d	102mm (without DIN rail)
Weight	appr. 890g

Installation notes

External fusing	<ul style="list-style-type: none"> <li>not necessary (internal fuse)</li> <li>observe national regulations</li> <li>circuit breaker with B-characteristic min. 6A or slower action, or alternatively 6A HBC fuse</li> </ul>
Mounting position	vertical; input below, output above
Free space for cooling	above / below 25mm recommended left / right 15mm recommended
Always connect PE before operating the unit!	

**Operation without AS-Interface:** This AS-Interface PSU has an inductive output. When operating without AS-Interface structure (e.g. in a laboratory test) you should connect a 470µF / 35V capacitor between AS-Interface + and AS-Interface - as commercial electronic loads in combination with the data decoupling often tend to oscillate, and the oscillation may exceed the permitted modulation voltage. Otherwise, equipment may be destroyed.

Functional diagrams

Start behaviour

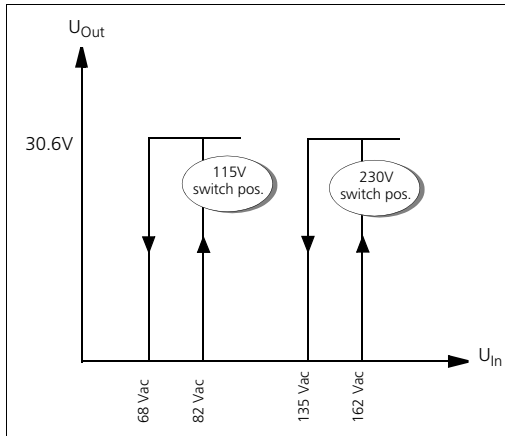

FUSE Mode / Signals and LED

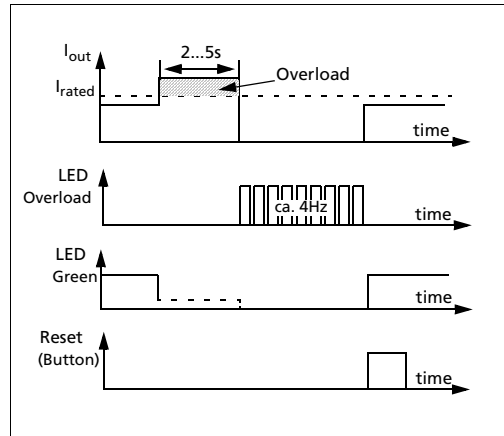

Efficiency / Power dissipation

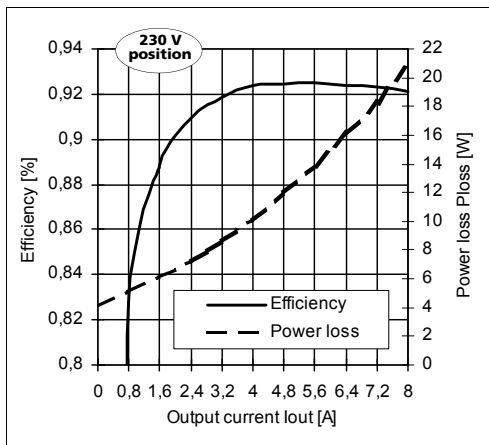

Overload response until FUSE Mode is activated

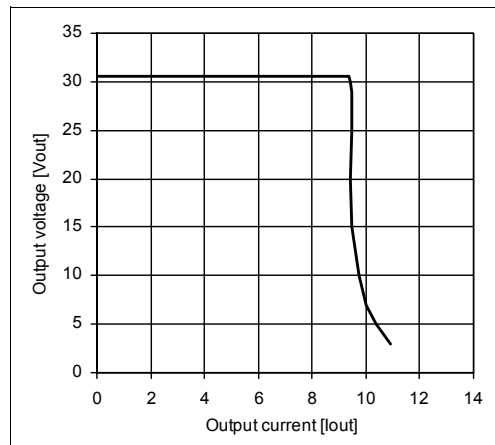

Hold-up time

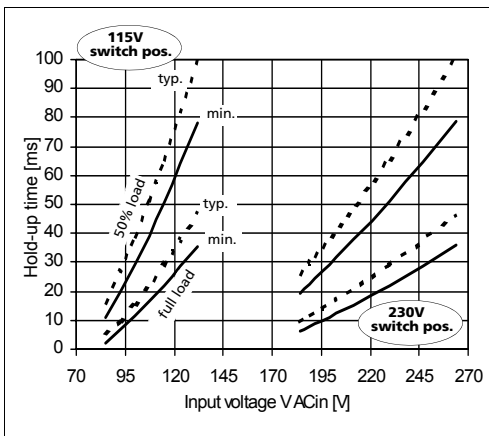

Derating

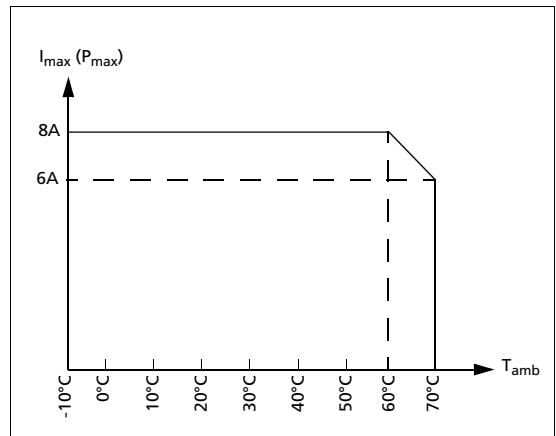

Unless otherwise stated, specifications are valid for AC 230V input voltage, +25°C ambient temperature, and 5 min. run-in time. They are subject to change without prior notice.

Your partner in power supply:



**PULS GmbH**  
 Arabellastraße 15  
 D-81925 München  
 Tel.: +49 89 9278-0  
 Fax: +49 89 9278-199  
 www.puls-power.com